

# **ASSEMBLY AND USAGE INSTRUCTIONS**

**for Photovoltaic Module**







**Support Structure**

# **FWD2 HDM2**



**Budmat.**

# Assembly Kit Components

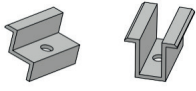
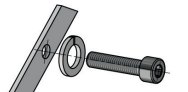
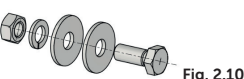
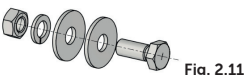
No.	Component	Name	Description	2x4 layout	2x5 layout	2x6 layout	2x7 layout
1.		FWD12 HDM SP	Front post	L2400 2 pcs.	L2400 3 pcs.	L2400 3 pcs.	L2400 4 pcs.
		FWS1 HDM2 ST	Rear post	L3497 2 pcs.	L3497 3 pcs.	L3497 3 pcs.	L3497 4 pcs.
2.		FWD1 HDM2 K	Rafter	L3720 2 pcs.	L3720 3 pcs.	L3720 3 pcs.	L3720 4 pcs.
3.		L4580: FWD1 HDM2 P1 L3174: FWD1 HDM2 P2 L3798: FWD1 HDM2 P3 L3226: FWD1 HDM2 P4 L2790: FWD1 HDM2 P5	Purlin	L4580 4 pcs.	L3174 8 pcs.	L3798 8 pcs.	L3226 8 pcs. L2790 4 pcs.
4.		FWD12 HDM24 W	Brace	L1000 2 pcs.	L1000 3 pcs.	L1000 3 pcs.	L1000 4 pcs.
		FWD1 HDM2 L	Bracket	L356 2 pcs.	L356 3 pcs.	L356 3 pcs.	L356 4 pcs.
5.		L2365: FWD12 HDM T	Splice	L2910 2 pcs.	L2910 2 pcs.	L2910 2 pcs.	L2910 2 pcs.
6.		FWD12 HDM MF	Inverter mounting	L2750 2 pcs.	L2750 2 pcs.	L2750 2 pcs.	L2750 2 pcs.
7.			End clamp 35	8 pcs.	8 pcs.	8 pcs.	8 pcs.
			Mid clamp	12 pcs.	16 pcs.	20 pcs.	24 pcs.
8.			DIN912 M8x35 A2 DIN912 M8x40 A2 ROMB M8 S320GD / ZM310 DIN 7980 M8 A2	M8x35 8 pcs. M8x40 12 pcs.	M8x35 8 pcs. M8x40 16 pcs.	M8x35 8 pcs. M8x40 20 pcs.	M8x35 8 pcs. M8x40 24 pcs.
9.			DIN933 M12x30 Tzn 8.8 DIN934 M12 TZn 8.8 DIN127 M12 TZn 8.8 DIN9201 M12 Tzn. 8.8	28 pcs.	50 pcs.	50 pcs.	72 pcs.
10.			DIN933 M12x30 Tzn 8.8 DIN934 M12 TZn 8.8 DIN127 M12 TZn 8.8 DIN125 M12 TZn 8.8	4 pcs.	6 pcs.	6 pcs.	8 pcs.

**Free-standing structure intended for fastening photovoltaic panels in horizontal orientation, resting on steel supports driven/concreted into the ground.**

The skeleton structure made of steel profiles **allows for the assembly of two rows** of photovoltaic panels inclined at **an angle of 25°** to the foundation.

The components are manufactured from S320GD steel with a ZM310/430 **MAGNELIS coating**. To join the components, screws of hot-dip galvanized steel (**TZn**) are used. **The structure has no welded joints, which minimizes the risk of corrosion.**

## Tools

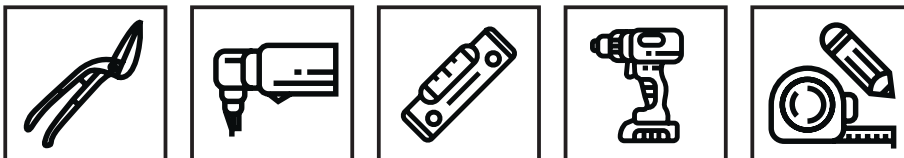

## OHS

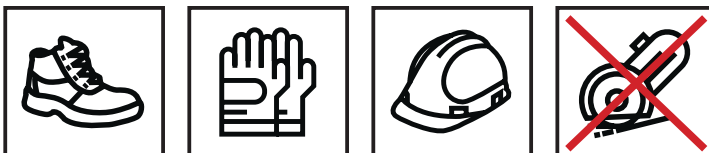

## I. TECHNICAL DOCUMENTATION OF THE COMPANY BUDMAT BOGDAN WIĘCEK

**THE MANUFACTURER OF THE STRUCTURE SHALL BE EXEMPTED FROM ANY OBLIGATIONS UNDER THE WARRANTY UNLESS THE PURCHASER OBSERVES THE GUIDELINES SET FORTH IN THIS DOCUMENTATION**

### 1. Purpose of the technical documentation

The aim of this technical documentation is to get the Purchaser/User acquainted with the structure, principle of operation and correct maintenance of the product, as well as to provide guidelines regarding its storage, assembly and transportation.

### 2. Packaging, storage and transport

The products should be packed in a manner preventing the loss of any component of the particular system. After receiving the delivery, please always check the product for its quality and possible lack of components in the respective kit(s).

Complete assembly systems are delivered to the recipient with protection against damage. The completeness of the delivery as well as appropriate condition of the delivered profiles shall be confirmed in writing by the recipient on the Stock Issue Confirmation or on any other equivalent document, on which comments regarding the product, provided there are any, should be written down.

### 3. Assembly

**The assembly is to be conducted in accordance with the instructions issued by Budmat.**

Recommended tightening torques during the assembly:

**- Mid and end clamps: 10-11 Nm,**

(Caution: During the tightening of the screws to the clamps, the rhombic Magnelis nut may become deformed at the torque of 11 Nm. This deformation is acceptable.)

**- M12 screws and nuts – 79 Nm,**

**- M 16 screw and nuts – 198 Nm**

**It is prohibited to interfere with the structure by drilling holes, grinding its edges, cutting it or carrying out other activities that may damage its protective layer, unless such an activity is admissible as per the instruction or Budmat consents to such an activity being carried out.**

The upper parts of the posts may become deformed while driven into the ground. In that case, the occurring deformations should be secured with zinc paint along the scratch. Remove any soiling from the components that has accumulated during the assembly immediately before proceeding to the next assembly phase.

### 4. Clamp fastening

**It is prohibited to use impact drivers with no tightening torque control. With power tools equipped with a mechanical clutch, the correct tightening torque may, as a rule, not be guaranteed, as it depends on the state of charge of the battery.** In this situation, control the tightening force with a manual torque wrench on an on-going basis.

**BUDMAT BOGDAN WIĘCEK SHALL NOT BE HELD LIABLE FOR DAMAGES AND DEFECTS CAUSED BY INCORRECT ASSEMBLY. ANY MODIFICATIONS MADE BY THE PURCHASER/USER SHALL RESULT IN THE WARRANTY BEING INVALIDATED.**

### 5. Product use

#### a) Maintenance

In order to ensure correct operation and a long useful time of the system, please check the fasteners twice within the first year of use. In the subsequent years of use, checks should be performed on a regular yearly basis. Check whether the fastening screws and ordinary screws are tightened and in the correct position. It is strictly prohibited to step on the structure and to put load on it in any other manner.

Should you notice any of the fastening components loosened, secure the area around the structure against unauthorised entry and, in compliance with OSH regulations and provisions of the instructions, perform a repair.

### **b) Cleaning**

In order to maintain the attractive appearance of the fastening structure, please clean it regularly. Clean components of the frame provide for a nicer look, longer durability and better functioning of the structure.

### **Caution!**

**Do not use alkaline cleaning agents! The glass on the panels is sensitive to alkaline substances.**

System components are best cleaned with water and sponge. However, neutral detergents may also be used.

## **6. OHS**

During the assembly, use and repair of the products covered by this technical documentation, please comply with generally applicable occupational health and safety regulations. Therefore, you should i. a.:

- Be equipped with personal protective equipment such as helmet and other types of protective gear;
- Use ladders, scaffoldings and other lift equipment, whose usability must be duly certified;
- Work with power tools with valid inspection documents. The same rule applies to extension cords and branch joints;
- Secure the area in which there is work in progress against unauthorised entry;
- Have a valid medical certificate for work at heights, if necessary.

## **II. TRANSPORT AND UNLOADING, MAGNELIS COATING**

During the assembly, use and repair of the products covered by this technical documentation, please comply with generally applicable occupational health and safety regulations.

### *General rules of handling and working with Magnelis-coated profiles*

1. For cutting the profiles, use electric sheet metal nibblers, shears, mitre saws etc. It is prohibited to cut the profiles with an angle grinder. This tool causes the sheets to warm up and results in the Magnelis coating being damaged (burned out). Chips resulting from the cutting may cause corrosion of the processed profile and of other profiles in its immediate proximity.
2. If a grinder is used, no claims will be accepted.
3. After each cutting of and drilling of holes into Magnelis-coated profiles, any swarf should be removed otherwise it may cause corrosion when in contact with the Magnelis-coated profile. Moreover, it poses a risk to the installer of getting hurt.
4. Any soiling occurring during the assembly works should be removed on an on-going basis.
5. Use protective gloves.
6. In the event of the Magnelis coating being damaged, mask the defects with zinc paint.
7. When working with Magnelis-coated profiles, comply with OHS regulations at all times.

### **Transport and unloading**

1. The profiles should be transported in their original Budmat steel packaging.
2. The vehicle transporting Magnelis-coated profiles should be adapted to this kind of transportation. The loading, unloading and proper fastening of the goods for the time of transport should be made easy for the person carrying out these activities.
3. Before unloading, check if the documentation is compatible with the goods delivered. Inspect the delivered goods carefully, and in case of visible defects or incompleteness, describe them in detail in the protocol or consignment note and have the carrier sign these for confirmation.

### Post positioning – Wind rose

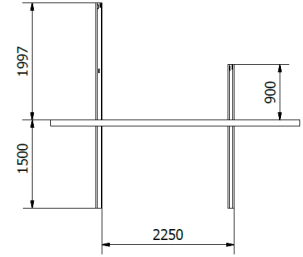
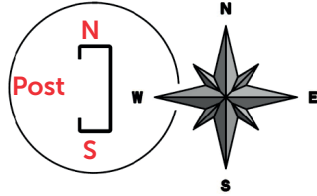

Fig. 5a

Fig. 5b

### 2x4 Layout

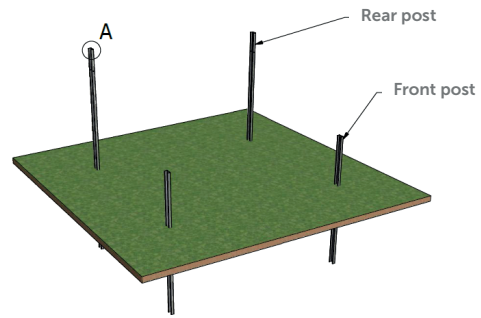
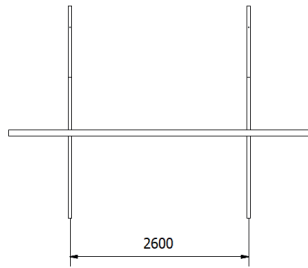

Fig. 5c

### 2x5 Layout

### 2x6 Layout

### 2x7 Layout

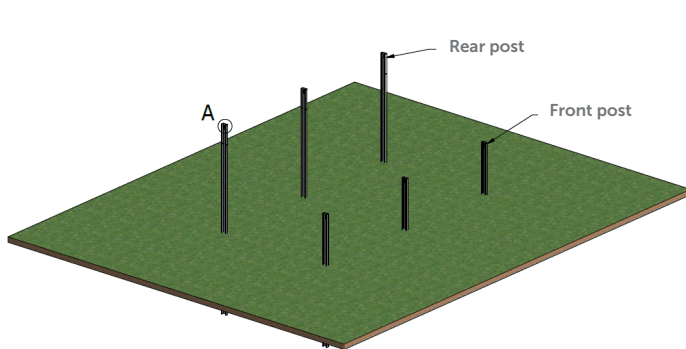
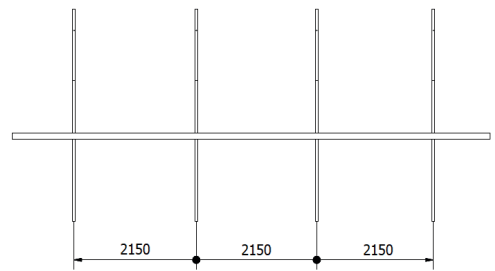
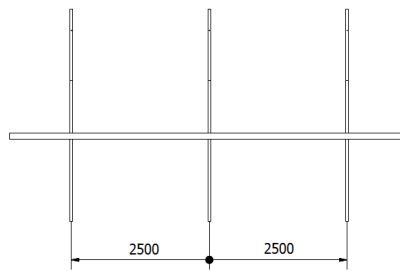
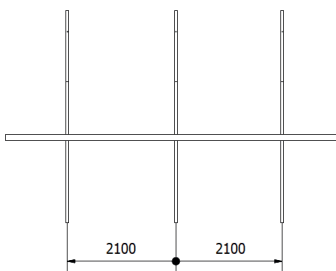

Fig. 5d

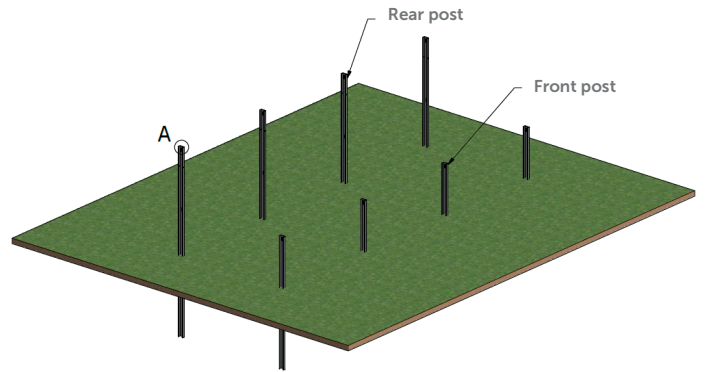

Fig. 5e

## Rafter Assembly

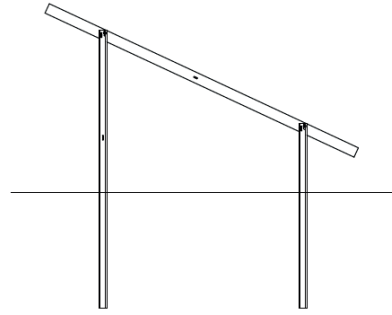

Fig. 6a

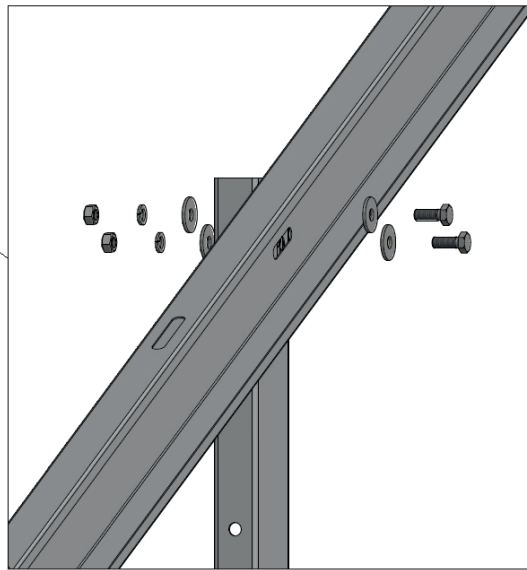
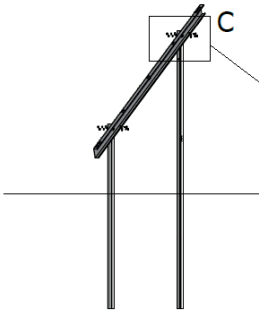

Fig. 6b

## Bracket (B) and Splice (S) Assembly

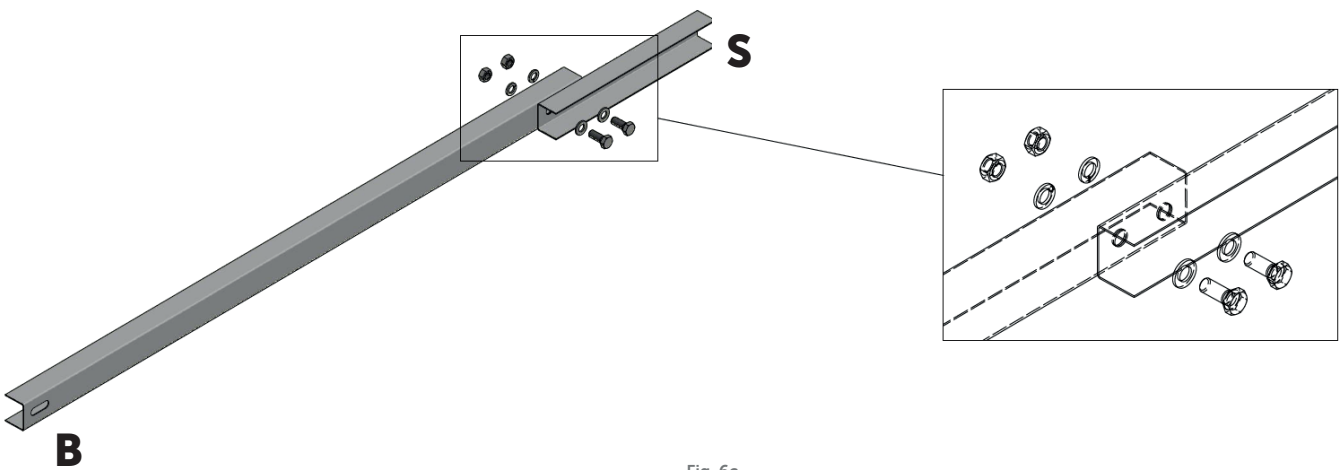

Fig. 6c

## Bracket (B) and Splice (S) Assembly

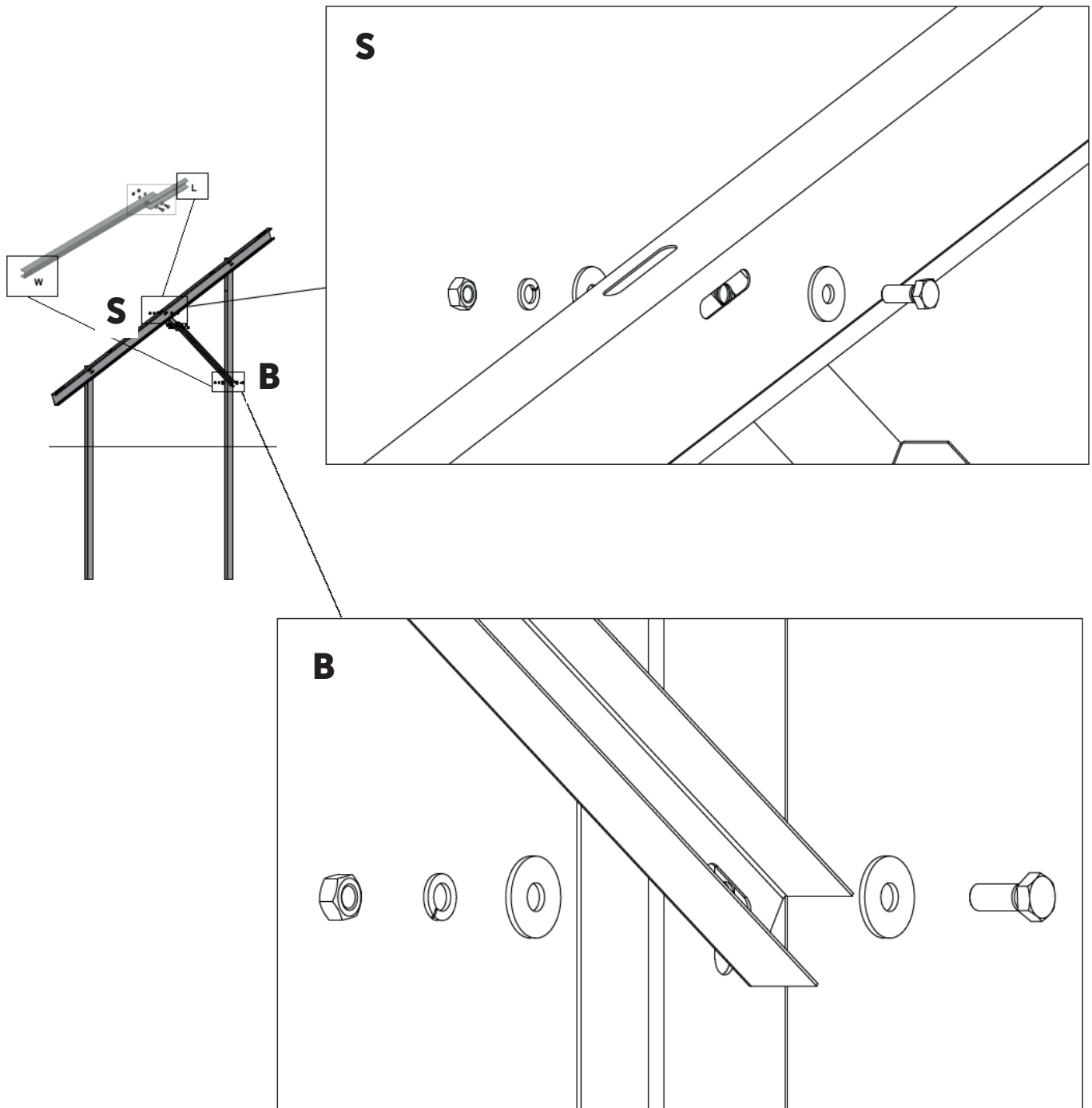
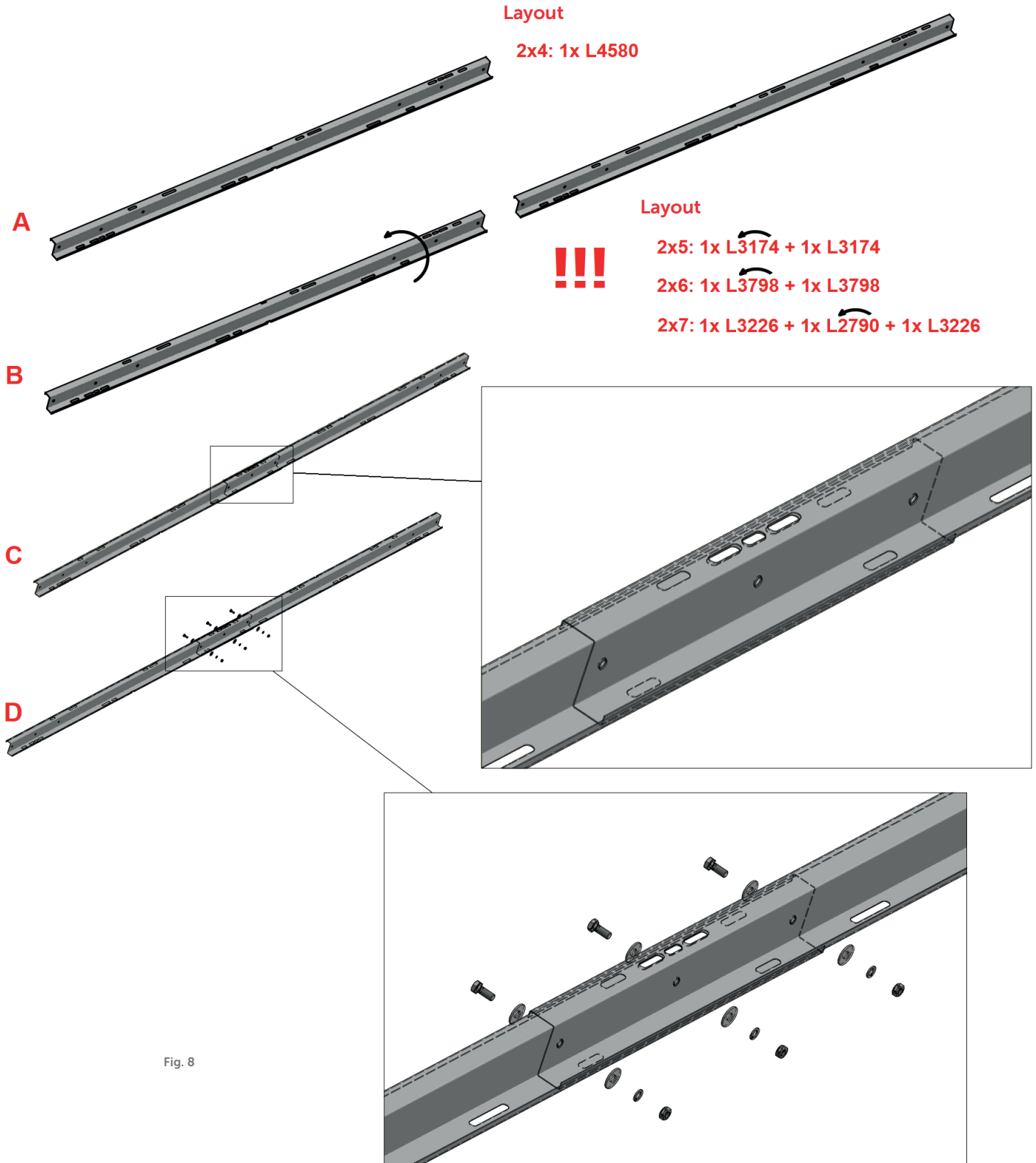

Fig. 7

# Purlin Assembly





## Purlin Assembly

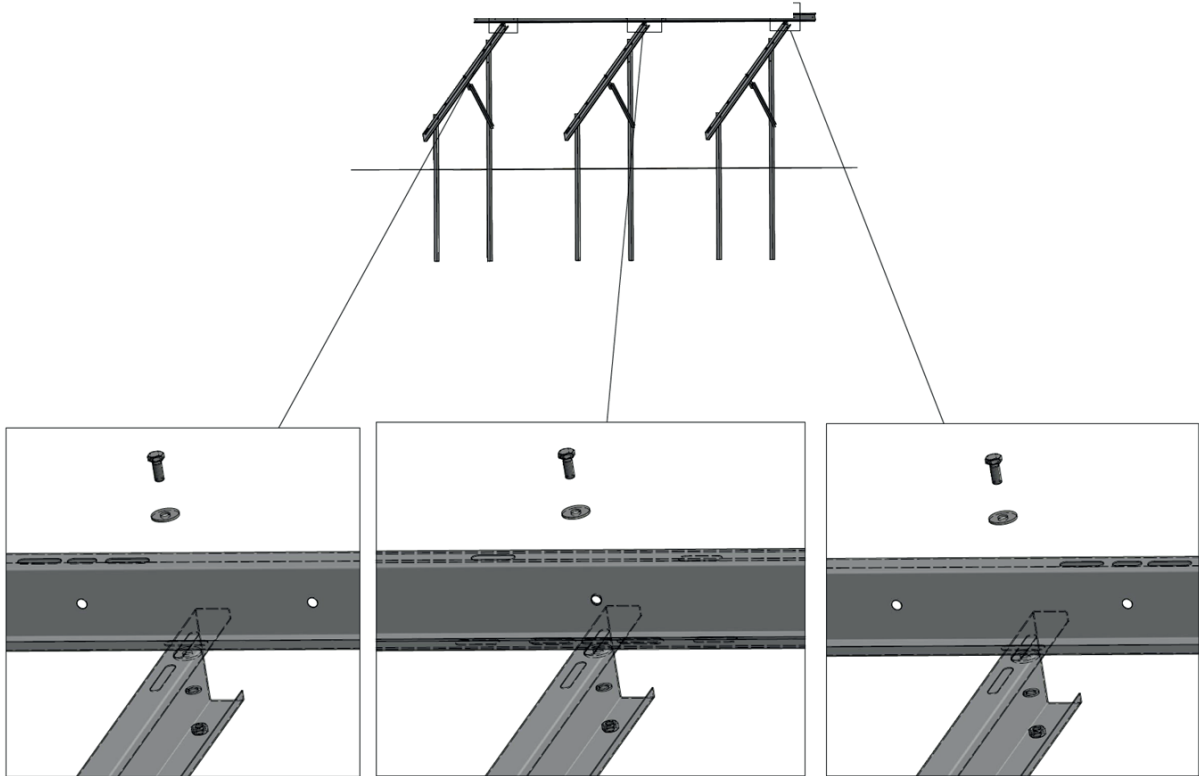

Fig. 8a



Fig. 8b

## Module Assembly

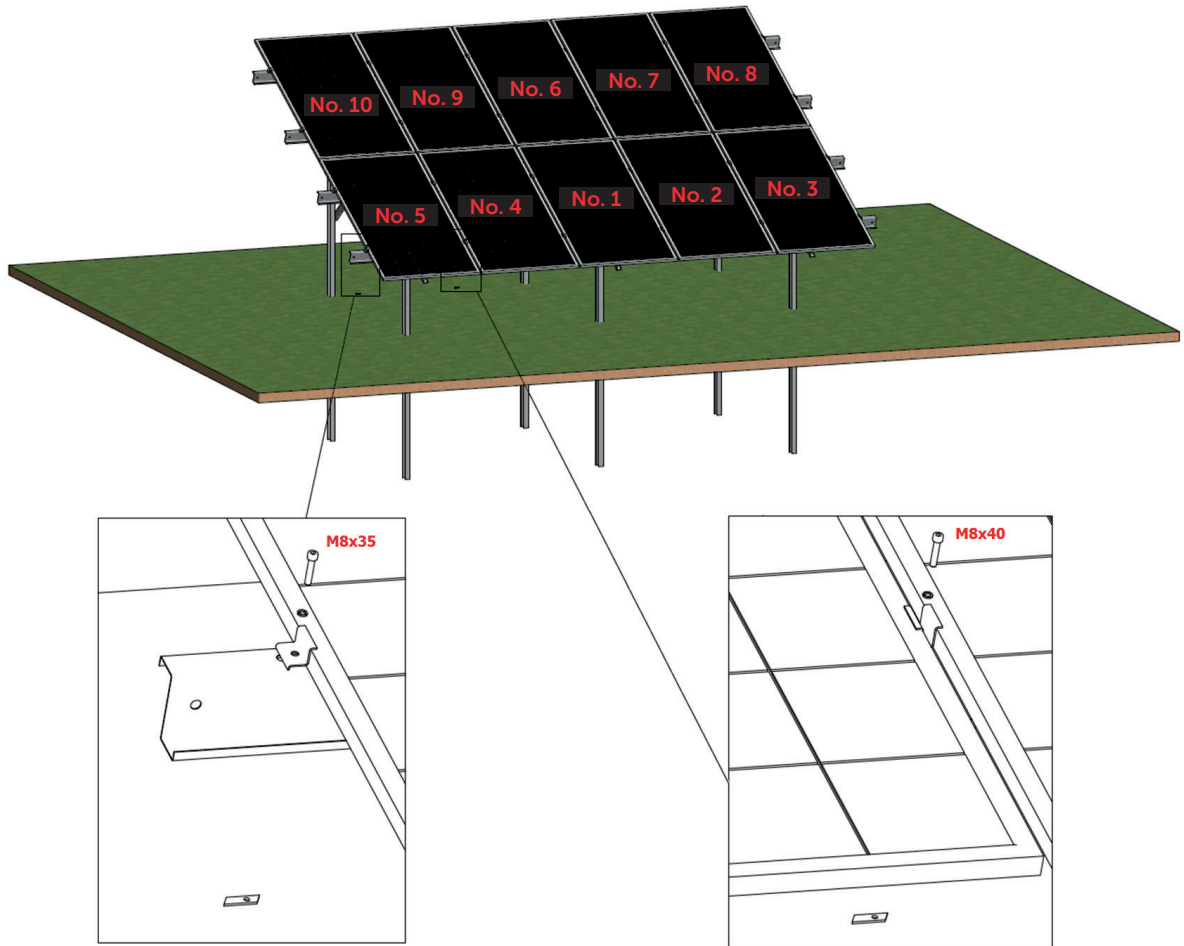

Fig. 10a

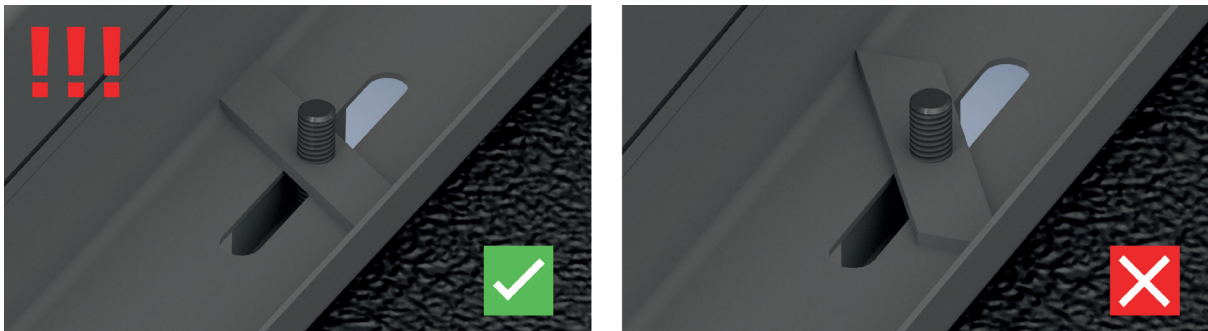

Fig. 10b

# X-Brace Assembly

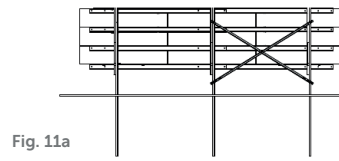

Fig. 11a

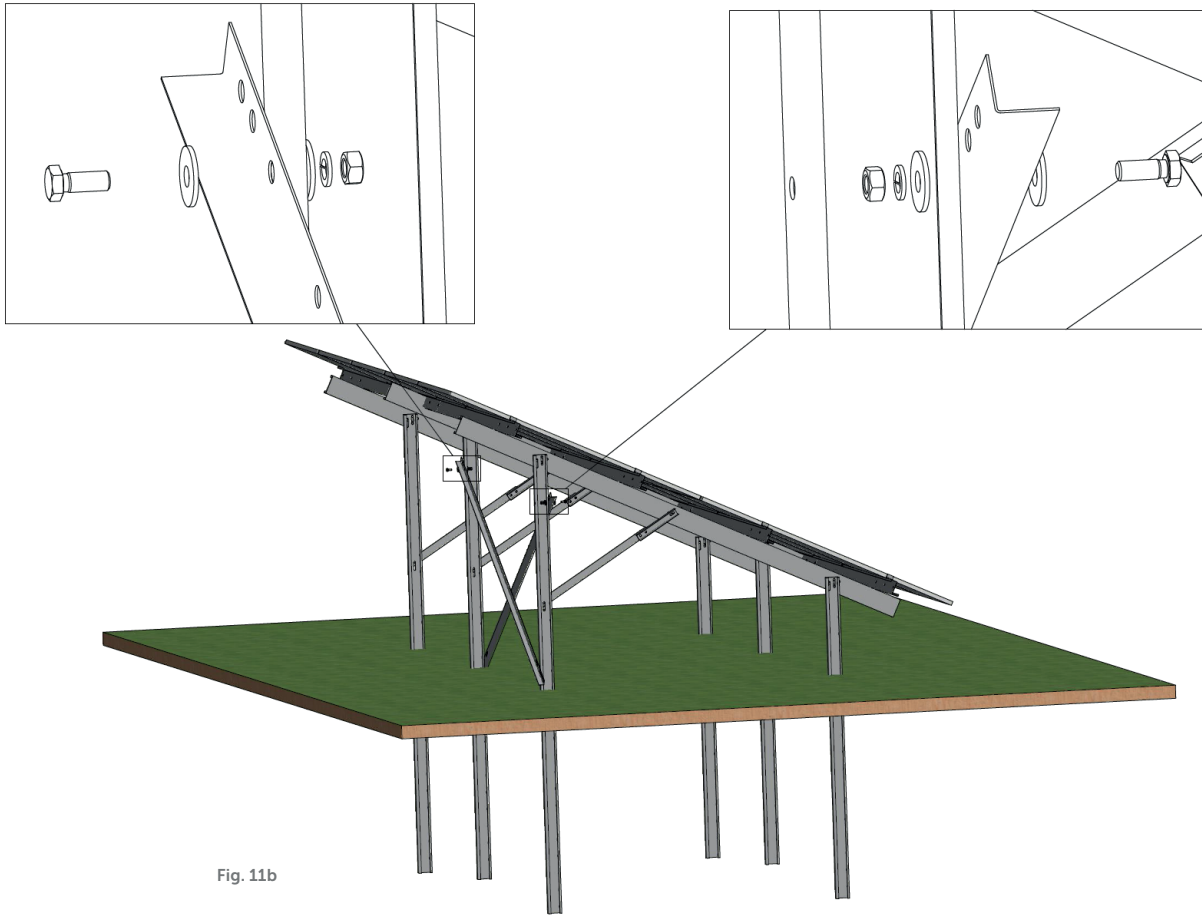

Fig. 11b

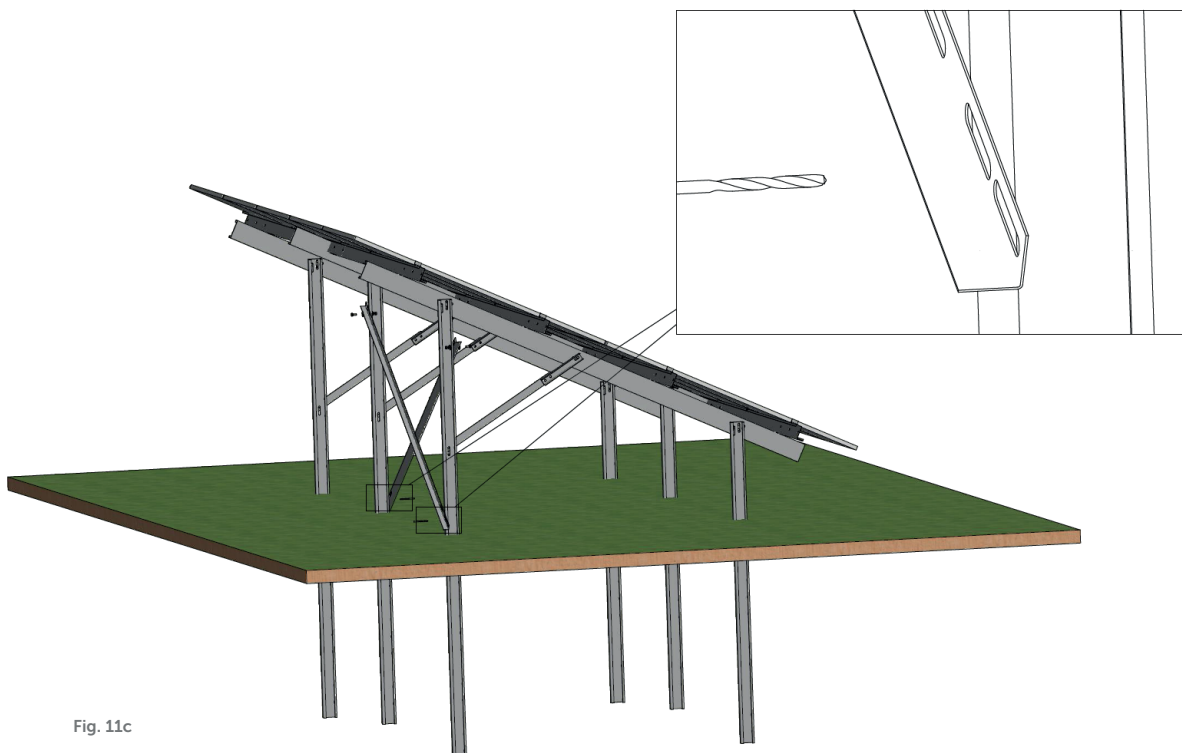

Fig. 11c

## Inverter Mounting Assembly

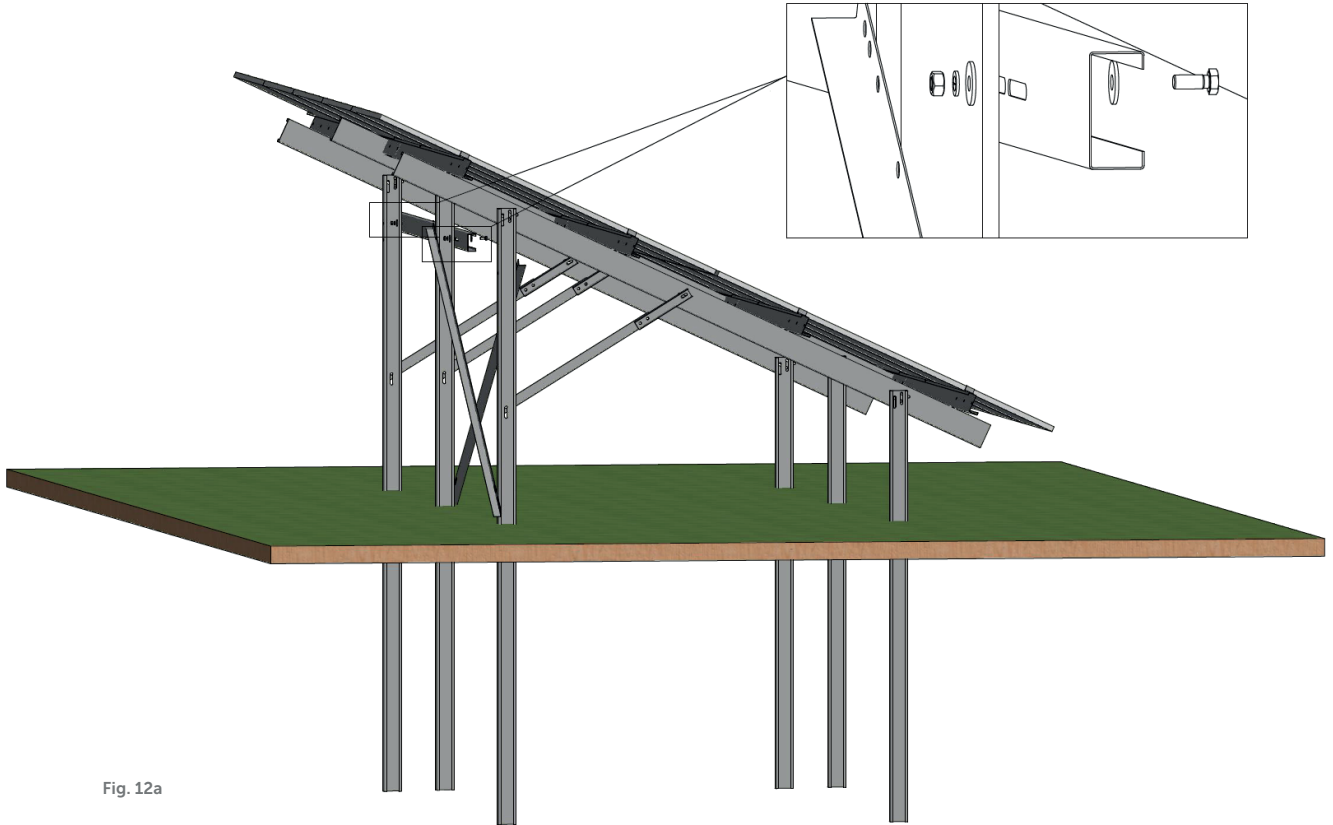

Fig. 12a

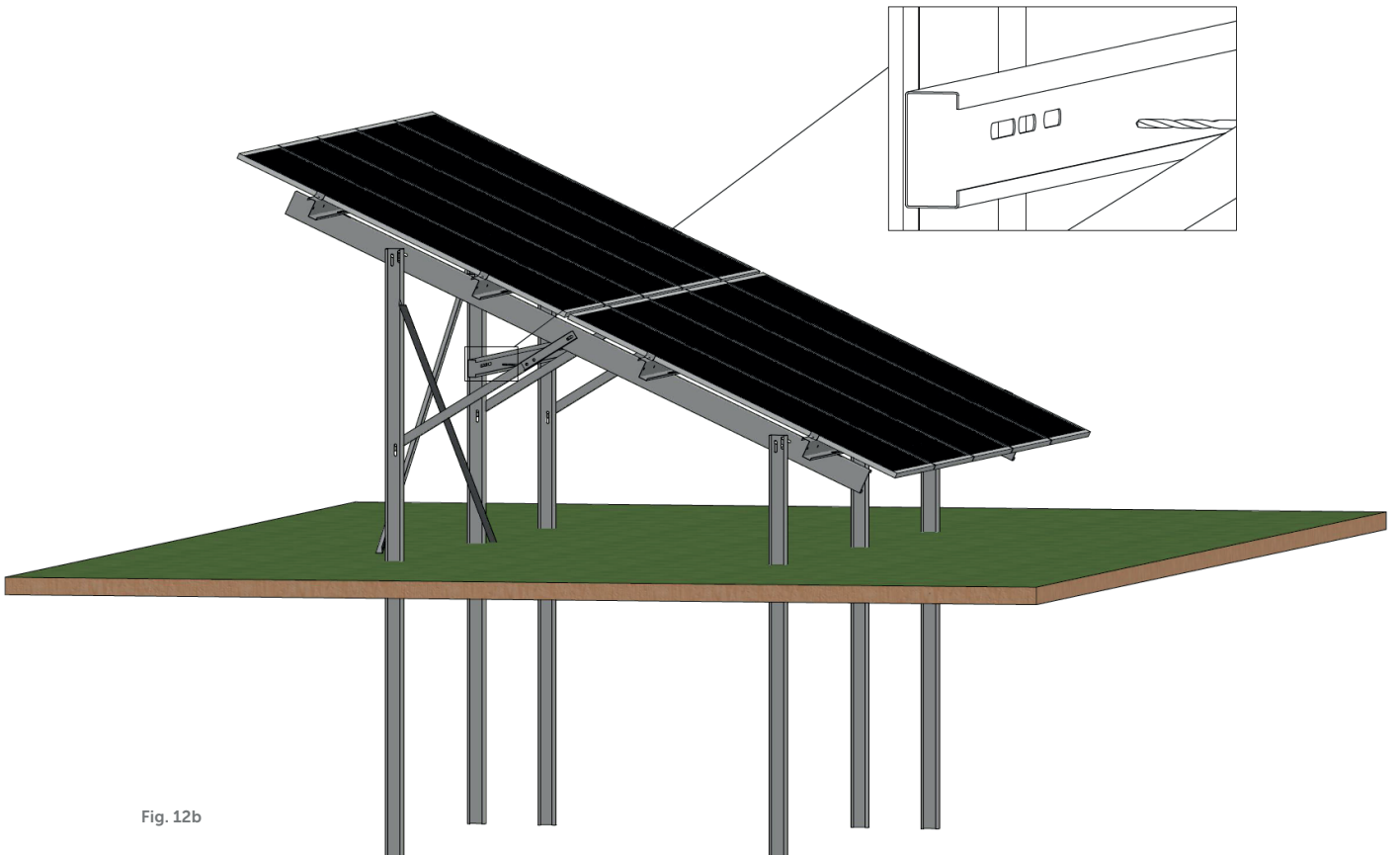

Fig. 12b



# Budmat.

## Systems PV

### Warranty Card

Freestanding Support Structure Components  
for Photovoltaic Modules

System Type and Name

FWD2 HDM2

Date of Sale by the Warrantor

Warrantor's Seal



ul.Ziejkowa 2A  
05-900 Gostynin  
systemypv@budmat.com

Installer's Seal and Signature with Assembly Date

Warranty's Data

The enterprise **BUDMAT. Bogdan Więcek**, hereinafter referred to as "the Warrantor", provides a **10-year warranty against perforations resulting from corrosion** in freestanding support structure components for photovoltaic modules manufactured by the Warrantor

The enterprise Budmat. Bogdan Więcek, 09-407 Płock, ul. Otolińska 25, Poland, NIP [Tax ID] 774-001-50-83, provides a warranty, hereinafter referred to as "the Warranty", on freestanding support structure components for photovoltaic modules (hereinafter referred to as "Structure Components").

#### WARRANTY TERMS AND CONDITIONS

1. This Warranty covers exclusively freestanding support structure components for photovoltaic modules which have been installed by an enterprise carrying out such type of work professionally, and the purchased structure components have been transported, stored, assembled and maintained in accordance with the rules set forth in the Assembly Instructions for Freestanding Support Structure Components for Photovoltaic Modules that comes with the Structure Components, as well as in the General Terms and Conditions of Transport and Storage of Steel Sheets and Zinc-Coated, Zinc-Aluminium Coated and Organically Coated Products, which can be accessed at [www.systemypv.budmat.com](http://www.systemypv.budmat.com).
2. The Warranty covers the territory of the Republic of Poland. The Warrantee, whose data have been entered into the Warranty Card, is the possessor of the Structure Components.
3. The Warranty covers the lack of perforations resulting from corrosion of freestanding support structure components for photovoltaic modules exclusively.
4. The Warranty covers freestanding support structure components for photovoltaic modules manufactured by the Warrantor exclusively.
5. This Warranty shall be valid for a period of 10 years starting from the date of sale of the Structure Components as specified on the Warranty Card by the Warrantor, provided that the Warrantee has made a full payment for the Structure Components covered by the Warranty, and that the terms and conditions set out below have been observed.
6. A condition for obtaining a warranty for Structure Components is a proper execution of assembly works, as a result of which the Structure Components have been assembled into a support structure system for photovoltaic modules. Such works shall be carried out in accordance with the Assembly Instructions for Freestanding Support Structure Components for Photovoltaic Modules by an entity that carries out such type of works professionally.
7. Unless the conditions set out in the item above are observed, this Warranty shall not be provided.
8. The Warrantee is obliged, within the period of validity of the Warranty, to have carried out yearly, paid inspections of the support structure system for photovoltaic modules made of Structure Components covered by this Warranty. The first inspection shall be carried out within one year of the system assembly date as specified on the Warranty Card by the installer. Every subsequent inspection shall be carried out after 2, 3, 4, 5, 6, 7, 8 and 9 years from the above date. The inspections may be carried out exclusively by an authorised service provider or one accepted by the Warrantor. The warranty for Structure Components shall expire automatically if the Warrantee fails to have any of the yearly inspections carried out by the deadline.
9. The Structure Components must be cleaned on a regular basis by washing any soiling and deposits off them, especially dust and plant debris etc. which can result in a hindered water flow. Any noticed damage to the Structure Components must be repaired immediately. The Warranty does not cover defects resulting from a failure to carry out activities set out in this item.
10. The Warranty does not cover:
  - Any alterations of the Structure Component structure other than perforation resulting from corrosion;
  - Potential discolorations of Structure Components, regardless of their cause;
  - Ageing of the Structure Component coatings (passivation of the zinc-magnesium coating);
  - Structure Component corrosion starting from cut edges. When cut edge corrosion occurs, the Purchaser shall immediately take preventive measures described in the Assembly Instructions for Freestanding Support Structure Components for Photovoltaic Modules;
  - Structure Components put to use in highly aggressive or corrosive environments, i.e. when they are e.g. exposed to air with high levels of industrial pollution or salinity, in steady contact with water or corrosive chemicals, wood impregnation agents causing corrosion of metals, in contact with ash, glowing remnants of burnt substances, corrosive smoke, cement dust and pollutants of animal origin, as well as with products that were in contact with corroded items, copper components and fluids flowing out of copper pipes. In particular, the Warranty does not cover Structure Components installed in environments characterised by C4, C5-I and C5-M corrosivity categories according to PN-EN ISO 12944-2:2001;
  - Mechanically damaged Structure Components, as well as the ones whose damage results from force majeure, vandalism etc.;
  - Structure Components for which proper fittings, i.e. delivered or specified by the Warrantor, have not been used, and Structure Components not installed in accordance with the Assembly Instructions for Freestanding Support Structure Components for Photovoltaic Modules;
  - Structure Components exposed to friction during the assembly and when in use.
11. The Warranty shall not apply if:
  - The Warrantee, when filing a complaint, does not produce a properly filled out Warranty Card, proof of purchase (invoice, receipt etc.) covering the claimed Structure Components along with an evidence of payment for the claimed Structure Components, and a confirmation of yearly inspections of the freestanding support structure system for photovoltaic modules referred to in item 8 of this Warranty;
  - The Structure Components made of zinc-magnesium-coated steel have been mechanically damaged, which in turn resulted in a damage to the anti-corrosion coating;
  - The damage to the Structure Components occurred due to an improper assembly of the system or parts thereof, in particular as a result of any of the poles supporting the freestanding support structure system for photovoltaic modules having been improperly driven into the ground or secured;
  - Defective components have been used in the process of assembling the Structure Components, including components damaged in such a manner that the system erected from the Structure Components does not maintain its alignment entirely or in part;
  - The Structure Components have been used contrary to their purpose, transported to another location or dismantled and reassembled by an entity which does not carry out such type of works professionally;
  - The Structure Components have been in any manner modified or combined with other components after being installed;

- Resulting defects do not impact the functionality of the system and its usability in accordance with its intended purpose;
- Damage to the Structure Components results from environmental or atmospheric impacts and is caused in particular by water, air or soil pollution, as well as by soil composition, occurrence of sulphur compounds, soot etc. in the air, and exposure of the system to excessive humidity (This applies particularly to environments characterized by C4, C5-I and C5-M corrosion categories in accordance with PN-EN ISO 12944-2:2001);
- Damage to Structure Components results from a failure to keep these clean, as a result of which it could have been caused due to a built-up of sand, leaves, algae, plants, bird droppings or effects of fertilisers, plant protection products etc.

12. The Warrantor reserves the right to carry out additional inspections of the freestanding support structure system for photovoltaic modules made of Structure Components covered by this Warranty for the duration of validity of the Warranty.

### **DELIVERY CONDITIONS**

13. Freestanding support structure components for photovoltaic modules are delivered in the same condition in which they are when leaving the profiling machine. Traces of lubrication may be present.

14. Cut edges may carry burrs. Burrs typical for the employed cutting method, as well as a slight deformation of the ending related to the cutting method may be present.

15. Small traces of rolling such as scratches or scrapes resulting from the production process shall not be a reason for filing a complaint.

16. Further processing (e.g. cutting, drilling, welding or other surface treatment) may result in changes of shape, straightness, and quality of the surface of the delivered Structure Components. Further processing of the Structure Components by way of cold-forming or hot-forming may impact their mechanical or technological characteristics, which the Warrantor shall not be held liable for. Any defects, including corrosion perforation, which resulted from further processing of the Structure Components by the Purchaser, shall not be covered by the Warranty.

### **RULES FOR FILING AND PROCESSING COMPLAINTS**

17. Complaints under this Warranty shall be filed immediately after the discovery of a defect covered by the Warranty. The filing shall be made in writing, within 14 days of the day of the discovery, and sent by e-mail to reklamacje@budmat.com, or by letter to Budmat, Bogdan Więcek ul. Otolińska 25, 09-407 Płock, Poland.

18. The day of sending the e-mail or the registered letter shall be deemed the date of filing the complaint.

19. The Warranty does not cover the damage indicating that it resulted from a failure to immediately notify the Warrantor of the defect.

20. A necessary condition for processing a complaint is the presentation, along with the complaint, of:

- A copy of a properly filled out Warranty Card;
- A copy of a proof of purchase (invoice, receipt etc.) covering the claimed Structure Components along with an evidence of payment for the claimed Structure Components;
- A copy of a duly signed protocol of assembly works referred to in item 6 of this Warranty, resulting in the Structure Components being assembled into a support structure system for photovoltaic modules;
- A copy of confirmation of carrying out yearly inspections of the support structure system for photovoltaic modules made of Structure Components (in accordance with item 8) covered by this Warranty.

21. At the Warrantor's request, the Warrantee shall be obliged to produce the original documents named in the item above. A failure to produce any of these documents shall result in a refusal to deem the complaint justified.

22. The Warrantee shall be obliged to grant access to the claimed Structure Components to the Warrantor in order for the Warrantor to be able to carry out an inspection, and to grant access to a source of energy at the scene of the inspection. A failure to perform any of the above obligations shall result in a refusal to deem the complaint justified.

23. Until the complaint is considered, the Warrantee shall secure the claimed Structure Components from further potential damage and losses.

24. The Warrantor shall take a position on the complaint within 14 days of the day of its filing. The deadline for consideration of the complaint may be extended by the time needed to carry out additional laboratory tests. The choice of the manner of how the complaint is to be processed shall belong to the Warrantor.

25. In the event where the complaint is deemed justified, the Warrantor shall exchange the defective Structure Components against defect-free ones. The delivery of defect-free Structure Components shall be made at the Warrantor's expense within 30 days of the issue of the decision finding that the complaint is justified. This deadline may be extended due to force majeure. Force majeure is defined as external events, independent from the Parties' activities and impossible to be foreseen, particularly such as: war, fire, epidemic, flood, traffic blockades of suparegional nature, social cataclysms, disasters occurring on building sites, or structural collapses. The burden of proof of failure to perform an obligation due to force majeure lies with the Party invoking force majeure.

26. The Warrantor's liability under this Warranty shall be limited to the value of the Structure Components on the day of their sale by the Warrantor.

27. The Warrantor shall not be held liable for any indirect and direct damage suffered by the Warrantee resulting from potential defects of Structure Components covered by this Warranty or from exercising the rights arising from the Warranty.

28. In the event where a complaint filed by the Warrantee is deemed unjustified, the Warrantor shall charge the Warrantee with the costs incurred to process the complaint.

### **FINAL PROVISIONS**

29. The Warrantee hereby declares that he verified the number, technical data and completeness of the Structure Components on the day of their delivery.

30. The Warrantee hereby declares that he is acquainted with the content of this Warranty and that he accepts the Warranty under the above conditions.

31. Upon surrender of the Structure Components, the risk of loss or damage thereof passes to the Warrantee.

32. Any disputes arising out of this Warranty shall be resolved by general courts of law with territorial jurisdiction over the Warrantor's registered office.

## Warranty Card

Inspection Period	Inspection Date	Visual Assessment	Screw Force	Structure Cleanliness	Date / Seal and Signature of Authorised Service Provider	Owner's Seal and Signature
Assembly Confirmation						
Within 12 Months of Assembly Date						
Within 24 Months of Assembly Date						
Within 36 Months of Assembly Date						
Within 48 Months of Assembly Date						
Within 60 Months of Assembly Date						
Within 72 Months of Assembly Date						
Within 84 Months of Assembly Date						
Within 96 Months of Assembly Date						
Within 108 Months of Assembly Date						