



EzLogger Pro SERIES USER MANUAL



EzLogger Pro

Smart Data Logger

Ver 2.0
2021/07/27

Table of Contents

Chapter I: Safety Precautions	01
1.1 Safety Instructions	01
1.2 Schematic Symbols	01
Chapter II: Product Introduction	02
2.1 Product Introduction	02
2.2 Appearance Description	02
2.3 Description of LED Indicators	05
Chapter III: Equipment Installation	07
3.1 Packaging Information	07
3.2 Equipment Installation	08
Chapter IV: Electrical Connection	10
4.1 Port Description	10
4.2 Connection to the Inverter	11
4.3 Connection to the Environmental Monitor and Meter	13
4.4 Connection to the Computer	14
4.5 Connection to the Ripple Control Receiver	14
4.6 Connection to DRED	16
Chapter V: LAN EzLogger Pro Data Upload and Function Configuration	17
5.1 How to Use LAN EzLogger Pro	17
5.2 EzLogger Pro Configuration	18
5.3 Program Upgrade	27
Chapter VI : Website Monitoring	28
6.1 Register A New User and Add A Power Station	28
6.2 View Power Station Information	29
Chapter VII : Technical Specifications	31
Chapter VIII : Certification and Warranty	32
8.1 Certification Mark	32
8.2 Warranty Certificate	32
8.3 Warranty Conditions	32
8.4 Disclaimer	32









Chapter I: Safety Precautions

1.1 Safety Instructions

EzLogger Pro produced by Jiangsu GoodWe Power Supply Technology Co., Ltd. (hereinafter “GoodWe”) is designed and tested in strict accordance with the relevant safety regulations, however, as an electrical and electronic device, the following safety instructions shall be followed at the time of installation and maintenance, improper operation will cause personal injury and property damage to the operator and third party.

1. Prevent children from approaching EzLogger Pro.
2. Do not open the upper cover, unauthorized touching or replacement of components may cause personal injury and damage to EzLogger Pro, in this case, GoodWe will not be liable for such injury or damage or quality warranty.
3. Static electricity may damage electronic components, so appropriate measures shall be taken to prevent static electricity.

1.2 Schematic Symbols

	Minor or moderate injury may be caused
	It shall not be disposed of as ordinary waste, a special route is required for recycling
	Keep upright, and do not tilt or put upside down
	Recyclable
	Fragile! Handle with care
	Keep away from moisture
	CE mark
	Points of attention
	Explanation

Chapter II: Product Introduction



Introduce the appearance and function of EzLogger Pro.

2.1 Product Introduction



Introduce the main functions of EzLogger Pro.

EzLogger Pro is a dedicated device for the photovoltaic power generation system monitoring and management platform, which achieves interface aggregation, data acquisition, data storage, centralized monitoring, centralized maintenance and other functions for the inverters, environmental monitor, watt-hour meter and other devices in the photovoltaic power generation system.

2.2 Appearance Description



Introduce the appearance, specifications and ports of EzLogger Pro.

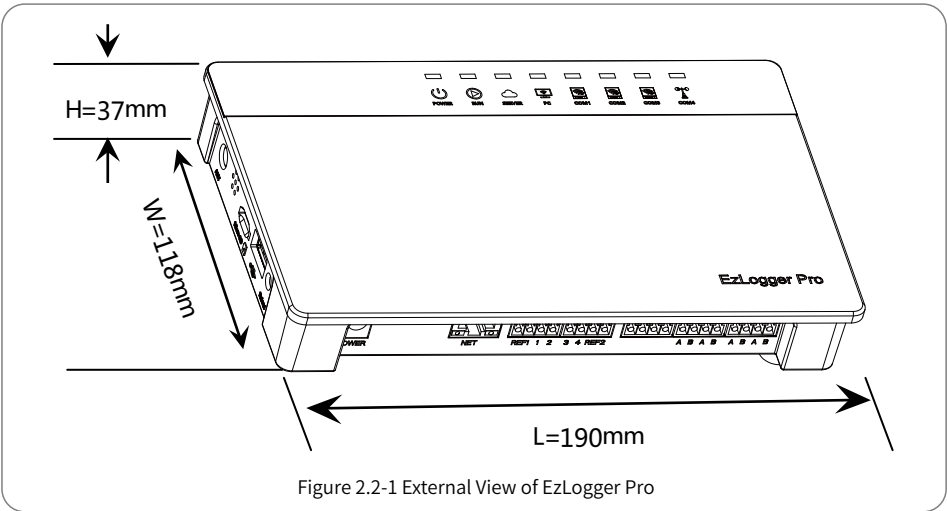
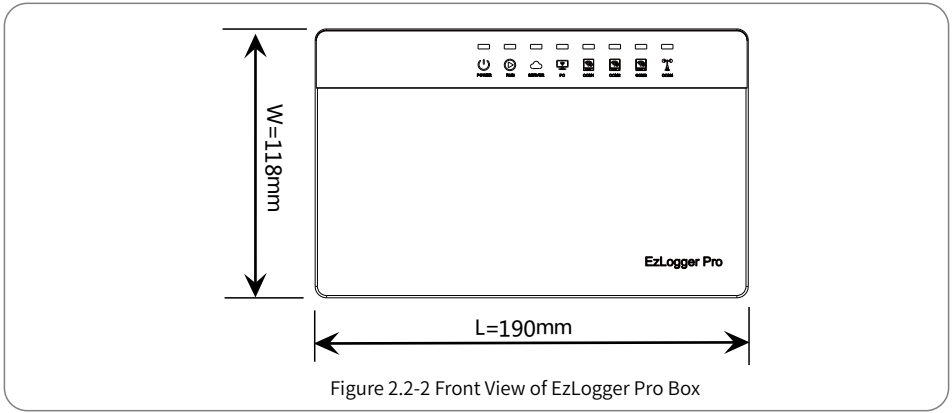
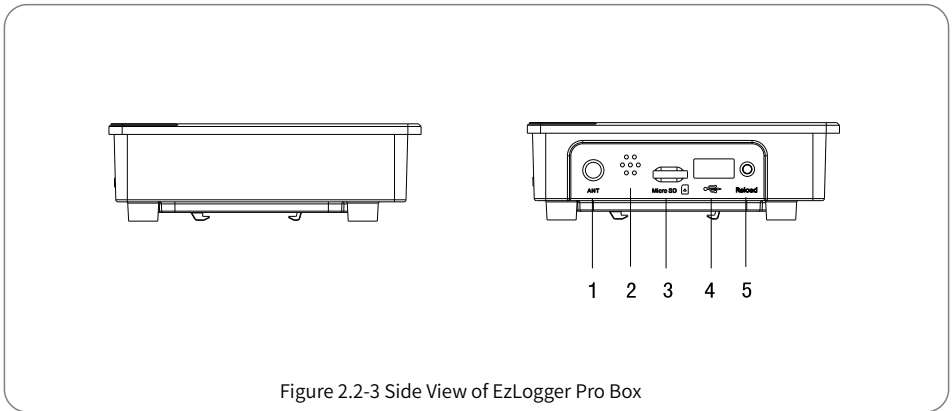

Figure 2.2-1 External View of EzLogger Pro

Front of the box



Side of the box



No.	Port	Port Description
1	ANT	Reserved Port
2	Sound alarm	Buzzer sound hole
3	Micro SD	SD memory card slot
4	USB	USB slot
5	Reload	Factory reset button

Back of the box

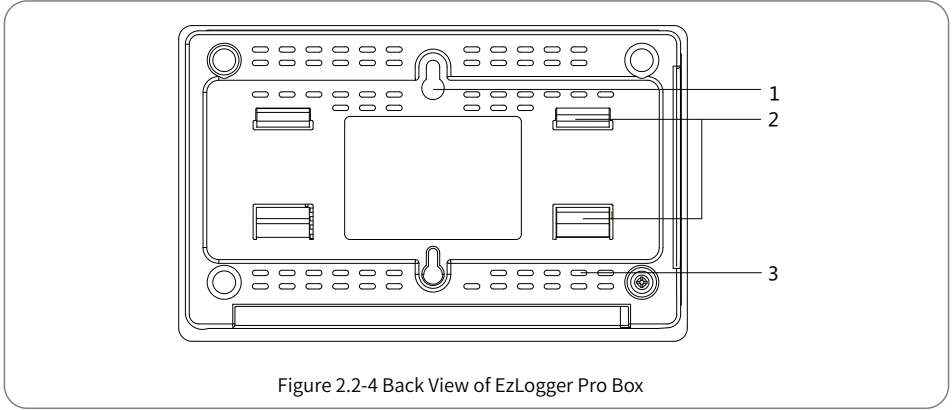

1. Wall mounting hole 2. Rail clip 3. Cooling vents

Top surface of the box

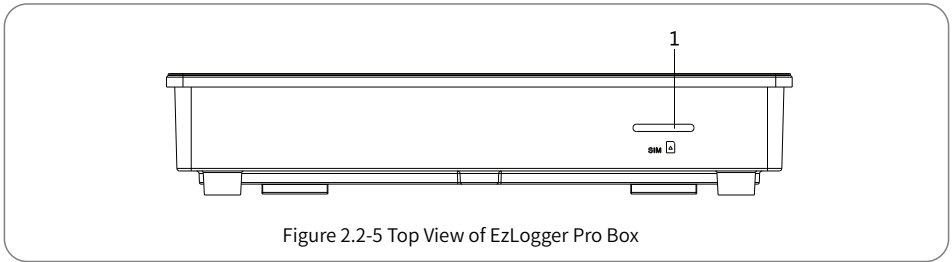

1. Reserved Slot

Bottom surface of the box

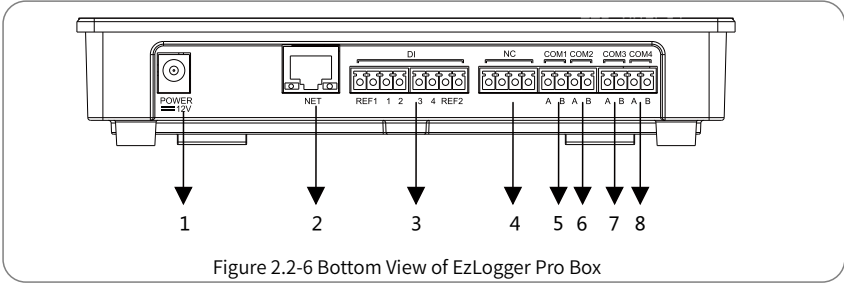

Figure 2.2-6 Bottom View of EzLogger Pro Box

No.	Port	Port Description
1	POWER	Adapter 12VDC input
2	NET	Ethernet port
3	DI	DRED or RCR function port
4	NC	Function reserved
5	COM1	RS485 communication port 1 for inverter
6	COM2	RS485 communication port 2 for inverter
7	COM3	RS485 communication port 3 for inverter
8	COM4	RS485 communication port 4 for environmental monitor and other devices

2.3 Description of LED Indicators



Introduce the meaning of the LED indicators.

The LED indicators are as follows:



Figure 2.3-1 Explanatory Drawing of LED Indicators

Description of the LED indicators is as follows:

Port	Status	Status Description
POWER	Blue light On	Power supply is normal
	Blue light Off	No power supply
RUN	Blue light flashes (1s On/Off alternately)	EzLogger Pro is running properly
	Blue light continue On or Off	EzLogger Pro is not running properly
SERVER	Blue light continue On	EzLogger Pro is properly connected to the external network server
	Blue light flashes (1s On/Off alternately)	EzLogger Pro is properly connected to the router, but not connected to the external network server
	Blue light Off	EzLogger Pro network is not connected
PC	Blue light On	EzLogger Pro is connected to the computer software ProMate
	Blue light Off	EzLogger Pro is not connected to the computer software ProMate
COM1	Blue light On	Number of inverters actually acquired by EzLogger Pro is equal to the parameter setting
	Blue light flashes (1s On/Off alternately)	Number of inverters actually acquired by EzLogger Pro is less than the parameter setting
	Blue light flashes (1s On and 3s Off alternately)	Number of inverters to be acquired according to EzLogger Pro the parameter setting is not set
	Blue light Off	No inverter data acquired by EzLogger Pro
COM2	Blue light On	Number of inverters actually acquired by EzLogger Pro is equal to the parameter setting
	Blue light flashes (1s On/Off alternately)	Number of inverters actually acquired by EzLogger Pro is less than to the parameter setting
	Blue light flashes (1s On and 3s Off alternately)	Number of inverters to be acquired according to EzLogger Pro parameter setting is not set
	Blue light Off	No inverter data acquired by EzLogger Pro
COM3	Blue light On	Number of inverters actually acquired by EzLogger Pro is equal to that to the parameter setting
	Blue light flashes (1s On/Off alternately)	Number of inverters actually acquired by EzLogger Pro is less than the parameter setting
	Blue light flashes (1s On and 3s Off alternately)	Number of inverters to be acquired according to EzLogger Pro parameter setting is not set
	Blue light Off	No inverter data acquired by EzLogger Pro
COM4	Blue light On	Communication of external environmental monitor and other devices is normal
	Blue light Off	No external environmental monitor and other devices

Chapter III: Equipment Installation



Introduce the packaging information and installation process of EzLogger Pro.

3.1 Packaging Information



Introduce the packaged accessories of EzLogger Pro.

After opening the EzLogger Pro package, please check whether the accessories are complete and there is any apparent damage. If there is any damage or certain items are missing, please contact your dealer.

Delivery diagram of accessories:







 EzLogger Pro x1	 Power adapter x1	 Guide rail x1	 WiFi Configuration x 1 (WiFi model only)
 Expansion screw x2	 User manual x1	 Wiring terminal x4	

Figure 3.1-1 Delivery Diagram of EzLogger Pro Packaged Accessories



Power adapter models will be determined according to the safety regulations of export destination countries.

3.2 Equipment Installation

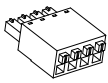

Introduction the installation process of EzLogger Pro.

3.2.1 Choose the installation location

The following points shall be considered when you select the installation location:

1. The ingress protection rating of EzLogger Pro is IP20, so it has no waterproof performance and is for indoor use only.
2. The installation method and location shall be suitable for the weight and size of EzLogger Pro.
3. The installation location shall be well-ventilated away from direct sunlight, and ensure the ambient temperature is within the range of -20°C ~ 60°C.

3.2.2 Install EzLogger Pro

There are three installation methods for EzLogger Pro, namely, table surface mounting, wall mounting and rail mounting.

Installation method 1: Table surface mounting



Please select the table surface mounting method for EzLogger Pro so as not avoid damage to EzLogger Pro due to falling. Do not put EzLogger Pro in a location where it touches cables easily so as to avoid signal interruption due to cable touching.

Installation method 2: Wall mounting

Steps:

1. Drill two circular holes in the wall. The distance between the two circular holes is 70mm, the hole diameter is 8mm, and the screw head protrudes 4mm.
2. Hang the wall mounting holes on the back of EzLogger Pro onto the screws.

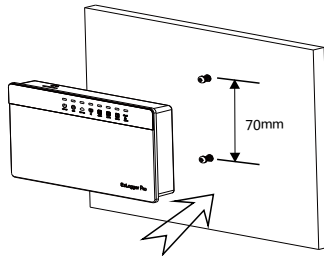

Figure 3.2.2-1 Schematic Diagram of Wall Mounting of EzLogger Pro

Installation method 3: Rail mounting

Steps:

1. Drill two circular holes in the wall, the distance between the two circular holes is 100mm, the hole diameter is 8mm, and the hole depth is 40mm.

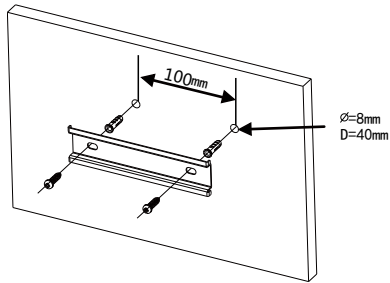

Figure 3.2.2-2 Schematic Diagram of Rail Mounting

2. Install the guide rail on the wall.
3. Install EzLogger Pro on the guide rail.

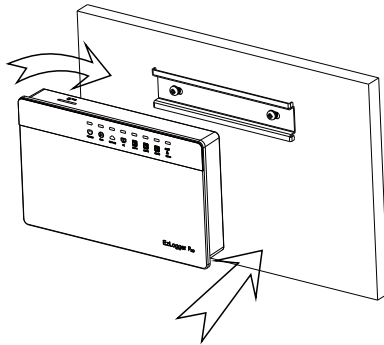

Figure 3.2.2-3 Schematic Diagram of Installation of EzLogger Pro onto Guide Rail

Chapter IV: Electrical Connection



Introduce how EzLogger Pro is electrically connected to the inverter, computer, environmental monitor, meter and other devices.

4.1 Port Description



Introduce the ports of EzLogger Pro for connection with the inverters and their functions.

The schematic diagram of the ports on the bottom surface of EzLogger Pro is as follows:

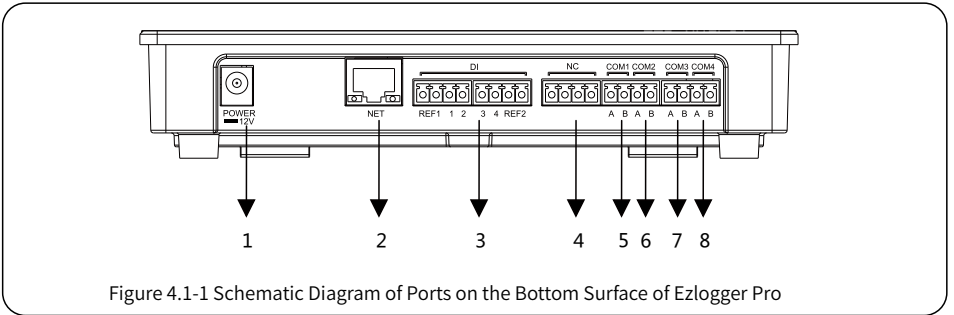

Figure 4.1-1 Schematic Diagram of Ports on the Bottom Surface of EzLogger Pro

The ports on the bottom surface of EzLogger Pro are described as follows:

No.	Port	Port Description
1	POWER	Adapter 12VDC input
2	NET	Ethernet port
3	DI	DRED or RCR function port
4	NC	Function reserved
5	COM1	RS485 communication port 1 for inverter
6	COM2	RS485 communication port 2 for inverter
7	COM3	RS485 communication port 3 for inverter
8	COM4	RS485 communication port 4 for environmental monitor and other devices



1. Below is the diagram of EzLogger Pro DI ports, where REF1 and REF2 occupy two ports respectively.

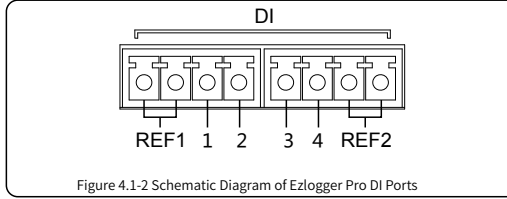

EzLogger Pro DI ports are compatible with RCR and DRED functions, and the ports for different functions are defined as follows:

	REF1	1	2	3	4	REF2
RCR	+5V	D_IN1	D_IN2	D_IN3	D_IN4	+5V
DRED	RefGen	DRM1/5	DRM2/6	DRM3/7	DRM4/8	Com/DRM0

2. COM1, COM2 and COM3 only communicate with the inverters, and COM4 is only connected to the environmental monitor and other devices, so avoid wrong connection.
 3. A of COM1, COM2, COM3 and COM4 ports corresponds to the differential signal +, B corresponds to the differential signal -.

4.2 Connection to the Inverter



Introduce how EzLogger Pro is connected to the inverter.

4.2.1 Connection to a single inverter



Introduce RS485 communication connection mode between EzLogger Pro and the inverter.

Through RS485, the inverter is connected to EzLogger Pro for communication, and EzLogger Pro has 3 RS485 ports, namely COM1, COM2 and COM3.

The diagram of COM1, COM2 and COM3 ports of EzLogger Pro is as follows:

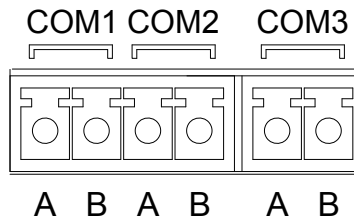

Figure 4.2.1-1 Schematic Diagram of COM1, COM2 and COM3 Ports of EzLogger Pro

COM ports are described as follows:

Port	Symbol	Description
COM1	A	RS485A, RS485 differential signal +
	B	RS485B, RS485 differential signal -
COM2	A	RS485A, RS485 differential signal +
	B	RS485B, RS485 differential signal -
COM3	A	RS485A, RS485 differential signal +
	B	RS485B, RS485 differential signal -

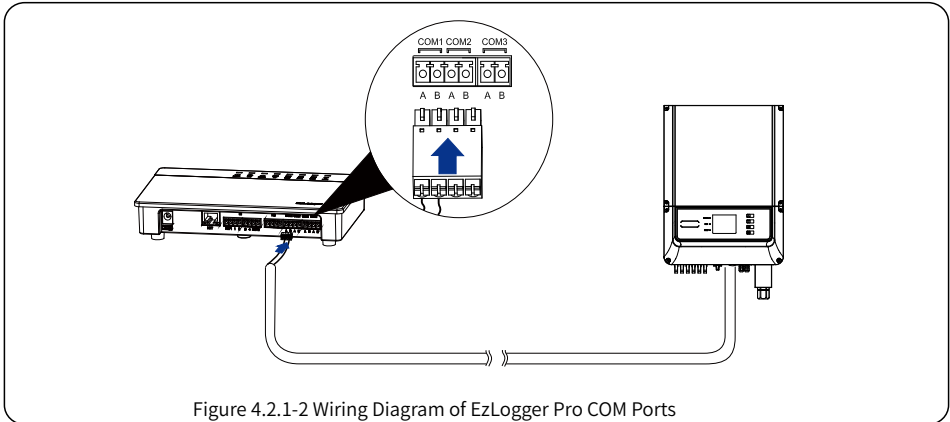

Figure 4.2.1-2 Wiring Diagram of EzLogger Pro COM Ports

Steps:

1. Select a RS485 communication cable of appropriate length ($\leq 1000\text{m}$).
2. First strip off the insulating layer at both ends of the communication cable.
3. Then connect one core of the communication cable with terminal A of EzLogger Pro COM port, and the other core with terminal B of EzLogger Pro COM port.
4. Another side connect to inverter, please refer to the meaning of RS485 port of inverter.
Note that COM"A" of Ezlogger Pro connect to the RS485"A" of inverter, COM"B" of Ezlogger Pro connect to the RS485"B" of inverter.



1. RS485 communication cable shall be a standard RS485 communication shielded twisted pair wire.
2. Inverter communication cable can only be connected to EzLogger Pro's COM1, COM2 and COM3.
3. A single COM port of EzLogger Pro supports a maximum of 20 inverters, and 3 COM ports support a total of 60 inverters.



Description of connection of communication cable with the terminal block:

1. First press and hold the corresponding white contact sheet of the wiring terminal to spring up the elastic metal sheet of the wiring terminal.
2. Insert the stripped portion of the wire cores into the terminal.
3. Release the white contact sheet to fasten the wire cores.

4.2.2 Connection to multiple inverters



Introduce how EzLogger Pro is connected to multiple inverters.

When EzLogger Pro is connected to multiple inverters, “hand-in-hand” connection method can be used; each inverter has two multiplexed RS485 communication ports, and one RS485 port of the inverter is connected to one RS485 port of the next inverter. Note that port A shall correspond to Port A, and Port B shall correspond to Port B, and the number of inverters connected to a single COM port shall not exceed 20.

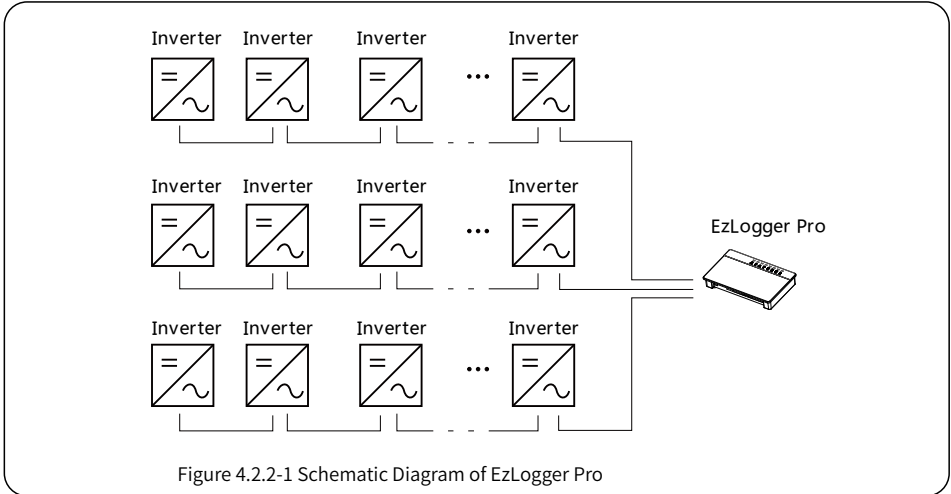

4.3 Connection to the Environmental Monitor and Meter



Introduce how EzLogger Pro is connected to the environmental monitor and meter.

When EzLogger Pro is connected to the environment monitor , meter and other devices, COM4 port shall be used.

Schematic diagram of COM4 port is as follows:

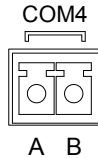

Figure 4.3-1 Schematic Diagram of EzLogger Pro COM4 Port

Description of COM4:

Port	Symbol	Description
COM4	A	RS485A, RS485 differential signal +
	B	RS485B, RS485 differential signal -

Steps:

1. connect one end of the communication line to the RS485 port of the environment monitor and the meter.
2. connect the other end of the communication line to the COM4 port of EzLogger Pro.



Please make sure that the RS485 + of the environmental monitor and meter is connected to COM4 “A” of EzLogger Pro, and the RS485 - of the environmental monitor and meter is connected to COM4 “B” of EzLogger Pro. Environmental monitor , meter and other devices can only be connected to COM4.

4.4 Connection to the Computer



Introduce how EzLogger Pro is connected to the computer.

Steps:

1. Insert one end of the network cable into the “NET” port of EzLogger Pro.
2. Insert the other end of the cable into the computer's Ethernet port.



When connecting to the computer, you need to use ProMate commissioning software. Please refer to 5.1 for ProMate software settings.

4.5 Connection to the Ripple Control Receiver



Introduce the functions of Ripple Control Receiver.

In Germany and parts of Europe, power grid companies use ripple control receivers to convert power grid scheduling signals for dry contact transmission, and power stations need to use dry contact communication method to receive power grid scheduling signals.

DI terminal interface of EzLogger Pro is as follows:

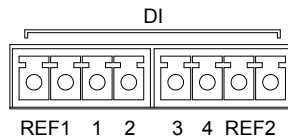

Figure 4.5-1 Schematic Diagram of EzLogger Pro DI Port

The port is defined as follows:

DI Port	Description
REF1	Active power derating
1	D_IN1
2	D_IN2
3	D_IN3
4	D_IN4
REF2	Reactive power compensation

EzLogger Pro is connected to the ripple control receiver as follows:

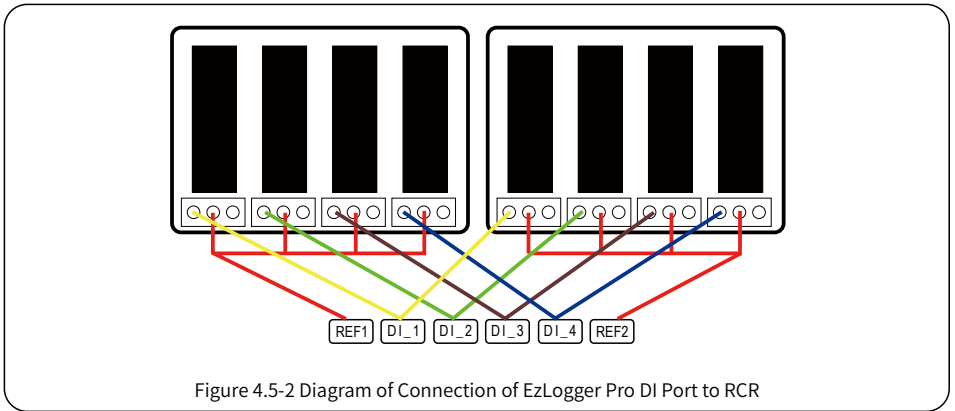

Figure 4.5-2 Diagram of Connection of EzLogger Pro DI Port to RCR

Steps:

1. Select a cable of appropriate length, and connect one end of the cable with the ripple control receiver.
2. Connect the other end of the cable with the corresponding DI port of EzLogger Pro, and refer to Section 4.2.1 Inverter RS485 communication connection method for detailed connection.

4.6 Connection to DRED



Introduce the function of DRED.

According to the Australian safety regulations, power grid companies use DRED to convert power grid scheduling signals for dry contact transmission, and power stations need to use dry contact communication method to receive power grid scheduling signals.

EzLogger Pro is connected to DRED or ripple control receiver using the same port, and the port is defined as follows when DRED function is used.

DI Port	Description
REF1	RefGen
1	DRM1/5
2	DRM2/6
3	DRM3/7
4	DRM4/8
REF2	Com/DRM0

When EzLogger Pro is connected to DRED, terminal connection method shall be used.

Steps:

1. Select a cable of appropriate length, and connect one end of the cable with DRED.
2. Connect the other end of the cable with the DI port of EzLogger Pro; note the definition of the port, and refer to Section 4.2.1 Inverter RS485 communication connection method for detailed connection.

Chapter V: LAN EzLogger Pro Data Upload and Function Configuration



Introduce LAN EzLogger Pro monitoring data transmission and the configuration method.

5.1 How to Use LAN EzLogger Pro



Introduce LAN EzLogger Pro monitoring data transmission.

After EzLogger Pro is connected to the collected data, one should connect EzLogger Pro to the Internet, so that EzLogger Pro can upload the collected data to the server. Dynamic IP (DHCP) is a default function for EzLogger Pro.

If the user's network equipment is available with the dynamic IP (DHCP), such as router, EzLogger Pro can be connected to the Internet in a plug-and-play way simply through direct connection of the NET port of EzLogger Pro to the LAN port of the router and the enabling of the dynamic IP (DHCP) function of the router. The collected Data will be automatically uploaded.

If the network equipment is available with static IP, you will need to switch EzLogger Pro to the static IP mode, then use our ProMate software to change the IP address of EzLogger Pro into the user's desired static IP address, and then connect to the user's Internet, as shown in the figure below. For more information about configuration, the user may refer to the static IP address connection configuration method of ProMate.

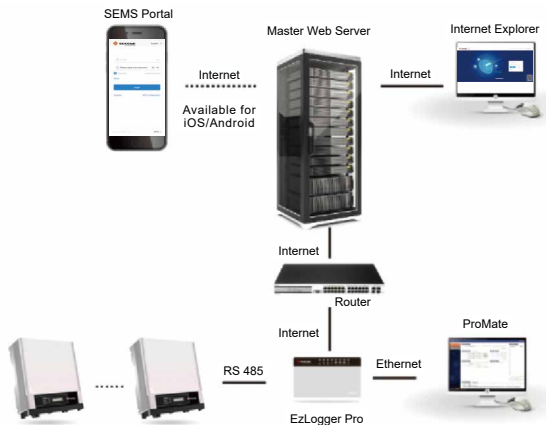

Figure 5.1-1 LAN EzLogger Pro Monitoring System Diagram

5.2 EzLogger Pro Configuration



Introduce how to use ProMate to configure EzLogger Pro.

5.2.1 Connecting ProMate to EzLogger Pro

ProMate software is launched by us for functional configuration of EzLogger Pro, by which we can realize modification to the IP address of EzLogger Pro, quantity setting of connected inverters for port, time setting, sound and light alarm, RCR, DRED enabling configuration, field debugging, etc.

Firstly, the user needs to install “ProMate” software in the computer. Please access to GoodWe official website and search for “ProMate” to download the program and complete the installation.

For connection of ProMate software to EzLogger Pro, the user needs to choose between dynamic IP (DHCP) and static IP, depending on the Internet configuration.

1. How to Assign a Dynamic IP Address to EzLogger Pro:

If the user has a dynamic IP, EzLogger Pro can be connected to the Internet in a plug-and-play way simply through the connection of the NET port of EzLogger Pro to the LAN port of the router with Internet cable. If you need to configure the EzLogger Pro, you should to connect your computer to the router with net cable. Open ProMate and click “Scan” in the ProMate software connection, so as to make the Internet connection successful. Then pull out cables from the computer and connect them to LAN port of the router, as shown in Figure 5.2-1.

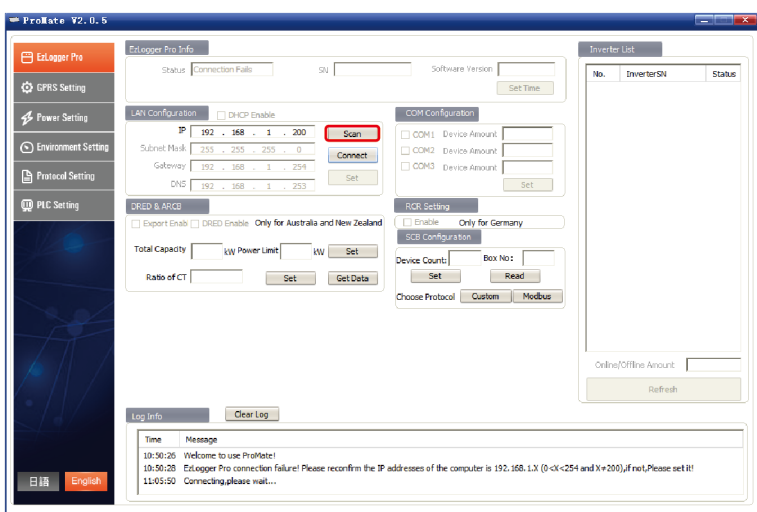

Figure 5.2-1 Connecting ProMate to EzLogger Pro by Scanning

2. Configuration Method for EzLogger Pro Static IP Address:

If the user has a static IP, it is necessary to switch EzLogger Pro to the static IP mode. That is, press the Reload key for about 10 seconds to reset and restart EzLogger Pro, The LEDs on EzLogger Pro will blink one after another from right to left. After restart, EzLogger Pro will be switched to static IP mode(default IP:192.168.1.200),then modify the computer' s IP address, take WIN7 as an example, the steps are as below. The user can find the methods from the Internet for modifying IP addresses of different computer systems.

- (1) Switch EzLogger Pro to static IP, then use cables to connect EzLogger Pro “NET” port to the Ethernet port of the computer.
- (2) Turn on the computer, right click on "Network " on the desktop, and click on “Properties” .

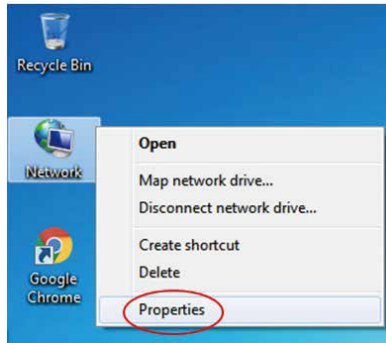

Figure 5.2-2 Open the Network Connections Window

- (3) Click on “Change adapter settings” .

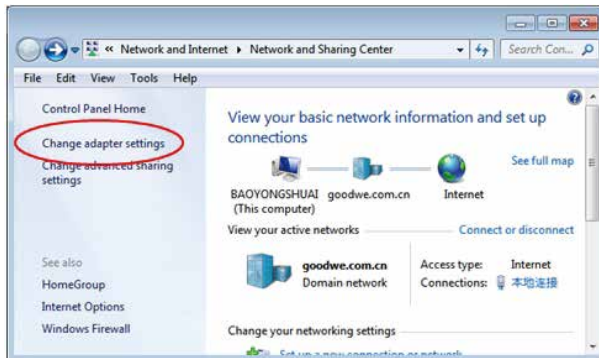

Figure 5.2-3 Modification of Adapter Configuration

(4) Pop up the local connection dialog box, right-click on “Local Connection” and then click on “Properties” .

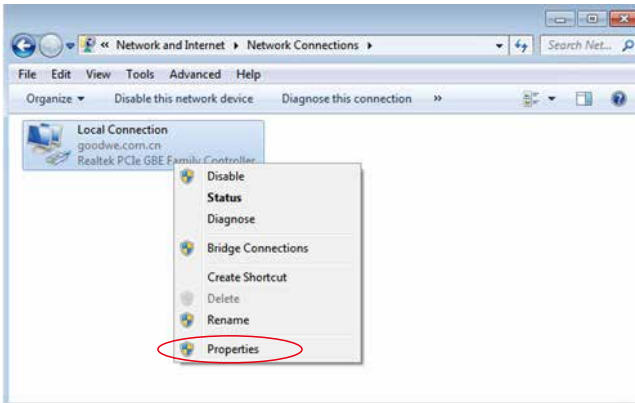

Figure 5.2-4 Modification of the Properties of Local Connections

Pop up a dialog box as below:

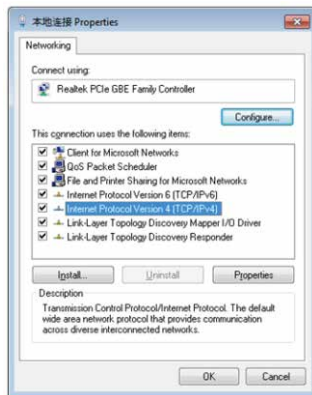

Figure 5.2-5 Modification of Internet Protocol 4 (TCP/IPv4)

(5) Double click on “Internet Protocol 4 (TCP/IPv4)” to pop up the “Properties” dialog box of “Internet Protocol 4 (TCP/IPv4)”, then complete the setting for the dialog box in accordance with the following requirements.

The defaulted IP address for EzLogger Pro is 192.168.1.200. In order to put your computer and EzLogger Pro under the same network segment, you should set the IP address and the default gateway in 192.168.1. XXX network segment ($1 \leq XXX \leq 250$ and $XXX \neq 200$).

For example:

The user can set the IP address as 192.168.1.100 and the default gateway as 192.168.1.254.

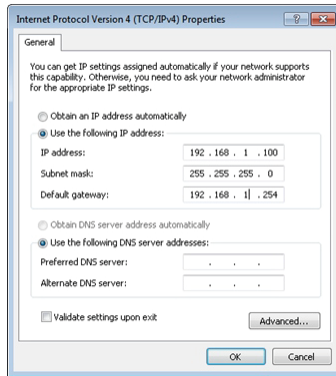

Figure 5.2-6 Modification of the IP Address

Click “Connect” button in ProMate to connect ProMate to EzLogger Pro, and the system will indicate “The connection is successful”, as shown in Figure 5.2-7.

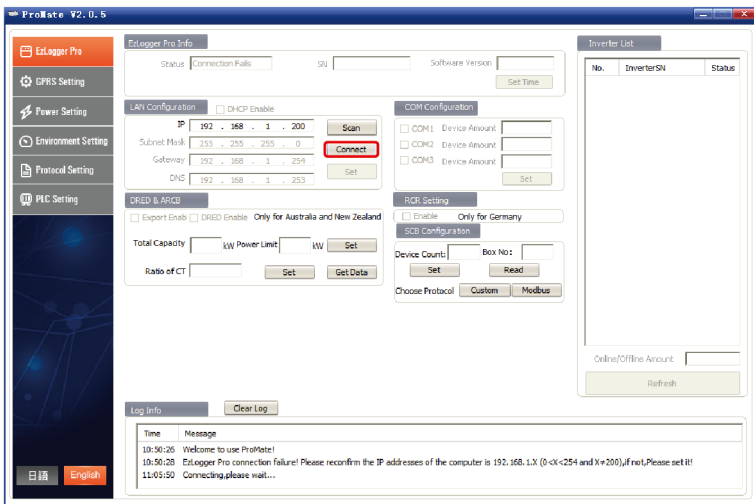

Figure 5.2-7 Connection between ProMate Software and EzLogger Pro in Static IP

(6) Modification to the IP address of EzLogger Pro.

The user can adopt the required configuration after connecting ProMate software to EzLogger Pro.

In static IP mode, the user can configure IP address, subnet mask, gateway and DNS that can be accessed to Internet as required, as shown in Figure 5.2-8.

For example:

The User's IP Address 192.168.1.101 The User's Gateway 192.168.1.254

The User's Subnet Mask 255.255.255.0 The User's DNS 208.67.222.222

Put the above data into LAN configuration, and then click the "Set" button to complete the set. Now IP address of EzLogger Pro has been modified as the configuration as required by the user, and physical connection between EzLogger Pro and ProMate can be disconnected after the configuration is completed. Then the Internet will be available just by plugging Ethernet cable into EzLogger Pro.

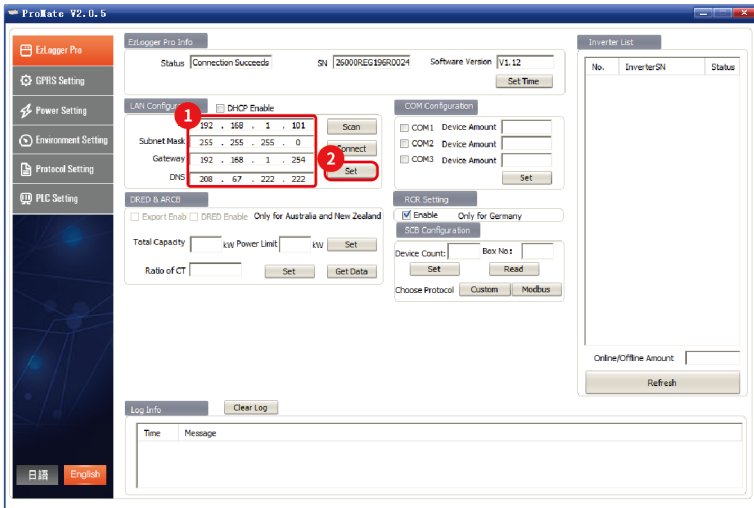

Figure 5.2-8 Modification to LAN Configuration

(7) After the configuration is completed, the user can pull out the cable which connected to Ethernet port of the computer, and then insert it into the router. At the same time, the user shall restore the IP address and other parameters of the computer to default settings. To change EzLogger Pro back to use dynamic IP, please long press RELOAD button for around 4 seconds. An ordinal LEDs blinking from left to right indicates EzLogger Pro is rebooting, after which, dynamic IP is set successfully.

5.2.2 Quantity Configuration for Inverter Communication Port

Terminal configuration is used for setting EzLogger Pro 's COM1,COM2,COM3 ports which the quantity of inverters connecting,assume port 1(corresponding communication port COM1) connecting the quantity of inverters is 7,then check port 1,the quantity settings is 7,click on “Set” button to finish the configuration. As picture 5.2-9.

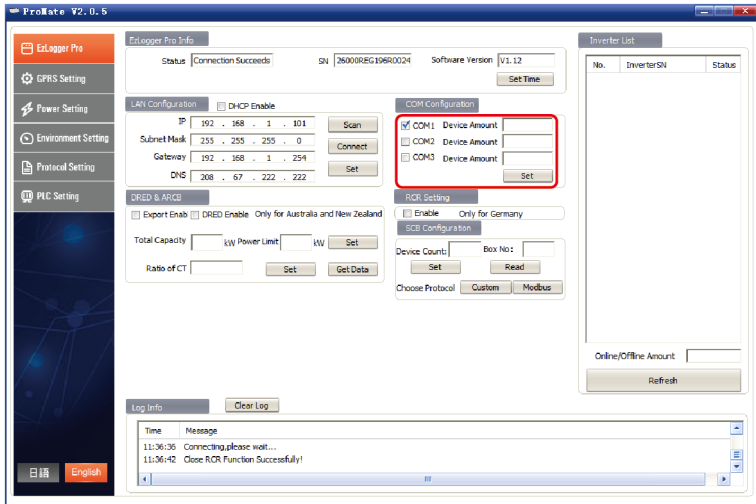

Figure 5.2-9 Parameter Configuration

Please set the quantity of devices of each port according to the quantity of inverters actually connected. Upon the completion of setting, the user can check the actual communication status of inverter from the LED indicator of EzLogger Pro (see Section 2.3 LED Indicator).

5.2.3 Time Setting

Time setting will synchronize the time of EzLogger Pro and inverter and the time of synchronization server. Click on “Set Time” to pop up the following dialog box, as shown in the figure below. Then click on “OK” after setting the time, as shown in Figure 5.2-10 and Figure 5.2-11.

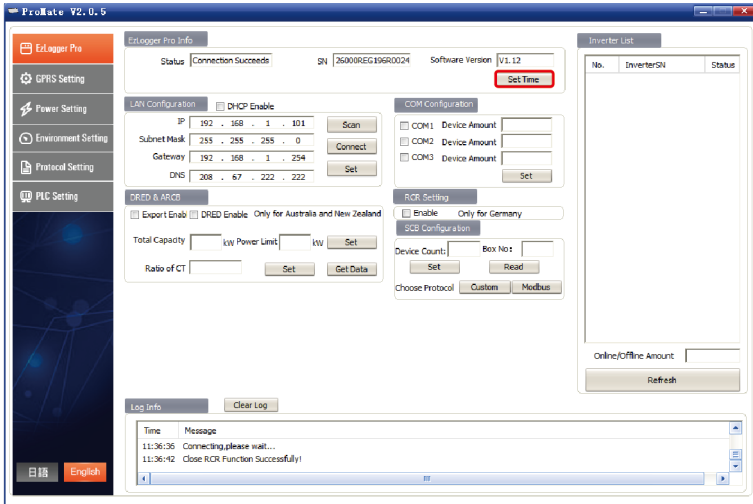

Figure 5.2-10 Time Setting

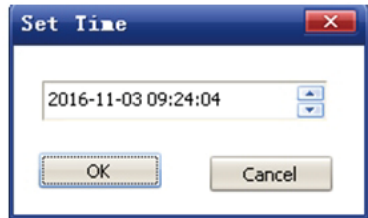

Figure 5.2-11 Time setting Dialog Box

5.2.4 Field Debugging

ProMate can also be applied to field installation and debugging. After installation is completed, click on “Refresh” to show whether the inverter is online or not. If the system prompts “off line”, please check whether the connection cable has any problem, and then timely solve the problems till the system shows that all the inverter are “on line”. It should be noted that it takes time to get the inverter status due to communication rate problems, as shown in Figure 5.2-12.

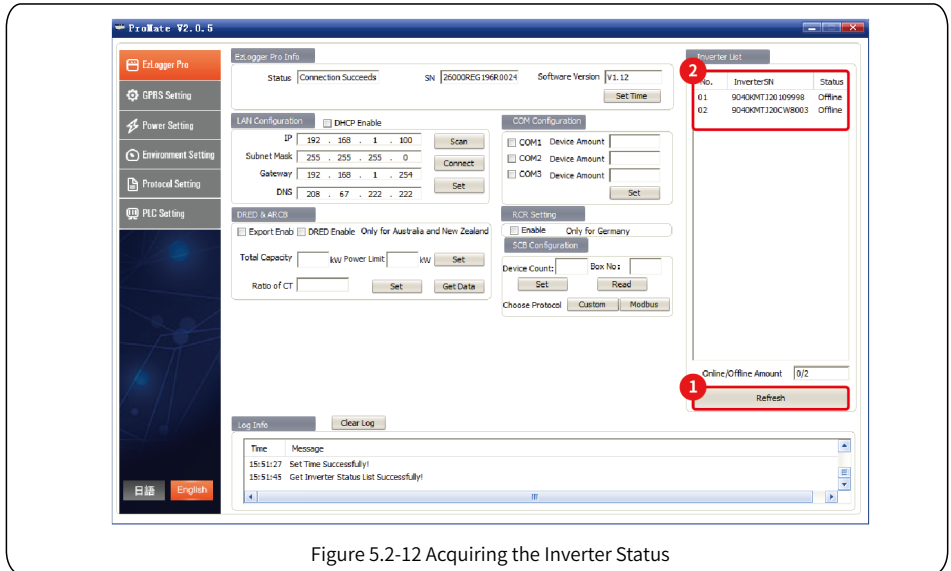

Figure 5.2-12 Acquiring the Inverter Status

5.2.5 DRED setting

DRED function can control the inverter’s generated power according to power grid control signal, only apply to Australia and New Zealand. Before start using DRED function, it will have to connect electricity meter well first and set inverter’s safety country, then set installation capacity and CT current ratio. Below instructions are installation capacity and CT current ratio:

1. Installation capacity: The inverter’s sum of rated generate electricity, such as there are 2 pieces of 10KW inverters on site, then the installation capacity is to set 20KW, calculate method is $2 \times 10KW$.
2. CT current ratio: Current transformer labeled input and output current ratio. For example, labeled ratio was 200/5, then CT current ratio setting is 40. Click “Start Using DRED” button after setting finished to achieve the configuration. As picture 5.2-13 showed.

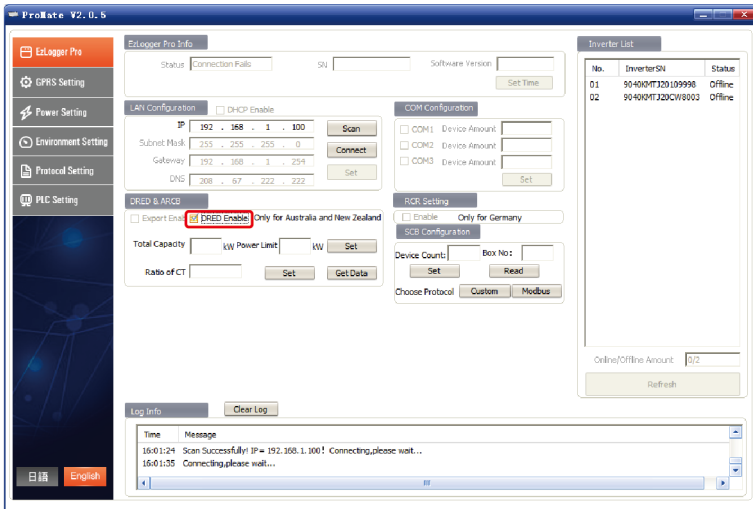

Figure 5.2-13 Enable DERD

After start using successfully, the “ Refresh ” column will display.

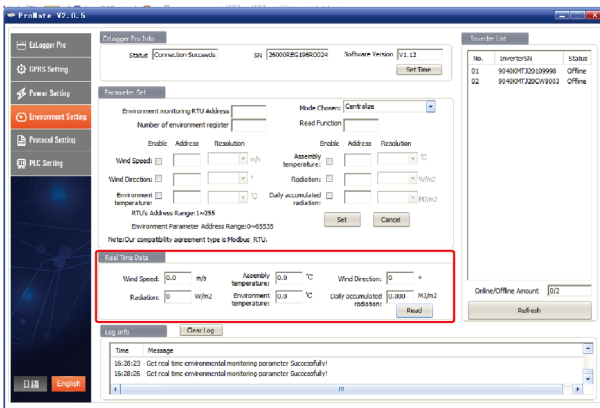

Figure 5.2-14 Real Time Data

Meter power means: The electricity meter measure the grid power, display positive value means the user sell electricity power value, display negative value means the user buy electricity power value.

Inverters power means: All of the inverters’ sum of generate electricity power value.

Load power means: Load consumption power.

When start using DRED function , if EzLogger Pro detects inverter had earth fault, then it will trigger sound-light alarm function: buzzer will ring for 1 minute, and RUN LED will be lighting for 1 minute. After 1 minute, the alarm will stop and keep on detecting every 30 minutes until fault disappearing.

5.2.6 RCR setting

RCR function only apply to Germany.If the customer needs to start using RCR function,please set inverter' s safety country first,then check “Enable” to enable RCR function.As picture 5.2-15.

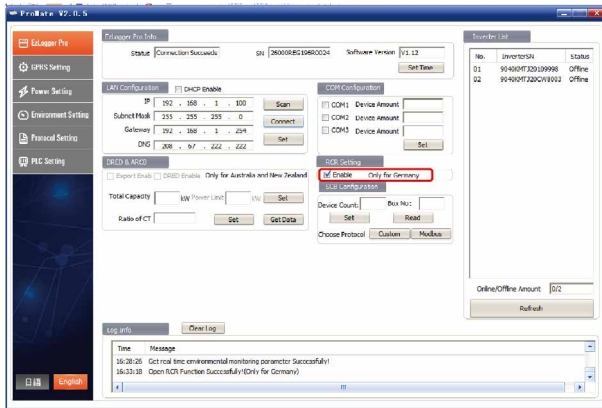

Figure 5.2-15 RCR Setting

5.3 Program Upgrade



Introduction to local and remote upgrade method of EzLogger Pro.

5.3.1 Upgrade EzLogger Pro

(1) Local Upgrade: Put the bin files required by upgrade in the root directory of U disk (please use the U disk with 2.0 port, FAT32 format), insert the USB flash disk in to the USB port of EzLogger Pro, cut off the electricity to EzLogger Pro and then repower it, so as to enable automatic update of the program.



The bin files for program upgrade is named as “EzLoggerPro_new.bin” . Bin files will be sent to client via E-mail. And the client shall save the received bin files in root directory of U disk, and check whether the file name is “EzLoggerPro_new.bin” or not. If not, please change into this name, otherwise inconsistent file names will cause the failure of the program upgrade. The shining of all of the eight indicator lights of EzLogger Pro in the program upgrade process indicates that the program is upgrading; the indicator lights will restore to the normal state when the program upgrade is completed. It is forbidden to cut off electricity in the program upgrade process.

(2) Remote Upgrade: Upgrade program is uploaded to the server by GOODWE in the background, so as to enable automatic check and update of EzLogger Pro.

Chapter VI : Website Monitoring



Introduce the registration, setting and monitoring methods for website monitoring.

6.1 Register A New User and Add A Power Station

The data acquisition terminal operates data via RS485 inverter acquisition. The data is uploaded to the server via Ethernet, and the user can log onto the monitoring platform to browse data and operating state information, and the monitoring platform website is <https://www.semsportal.com/Home/Login>. The following describes how to register and add power station information when the user logs on for the first time.

Step 1: Open the browser, then visit <https://www.semsportal.com/Home/Login>, and you can enter GOODWE monitoring platform homepage. Click **Language-English** to select language. Then log in using the account of the administrator or installer.



Log in use administrator's account or installer's account created by upper level organization, like by dealers. Refer to **SEMS Portal User Manual** if you want to create an organization or an account.

Step 2 : Create a PV plant , Select **Management > Plants**. Click **Create**.

G10014687Pv plantU677

Owner: Add

Email **Operation**

Please add owner information.

Visitor: Add

Email **Operation**

Please add visitor information.

Plant Info:

+

*Plant Name: *Capacity: kW

Classification: Distribution code: Keep it empty if you don't know the installer's code

*Profit Ratio: Amount of solar panels:

*Location: Map

Detailed Address:

Enable Profile: Enable Disable Creation Date:

Plant Profile: Distributed PV power plant refers to the operation mode of "construction and operation at the user's site or nearby, and implementation of "self-use, excess power to grid, nearby consumption and power grid adjustment" on the user side end in the distribution network system. The characteristics of photovoltaic power generation facilities are balanced and adjusted. Distributed photovoltaic power generation follows the principle of adapting to local conditions, clean and highly efficient, decentralized layout, and priority utilization, making full use of local solar energy resources to reduce and reduce fossil energy consumption. Without the use of fuel, the operating cost is very low; there are no moving parts, it is not easy to damage, maintenance is simple, especially suitable for use in unattended conditions. It will not produce any waste, no pollution, noise and other public hazards, no adverse impact on the environment. Outstanding environmental benefits. Distributed photovoltaic power generation is a new type of power generation and energy comprehensive utilization mode with broad development prospects. It can realize nearby power supply without long distance transmission.

Figure 6.1-1 Create a PV Plant

Step 3 : Add an EzLogger Pro in the PV plant. Click **Management > Plants**, select the corresponding PV plant and click **Device Management**.

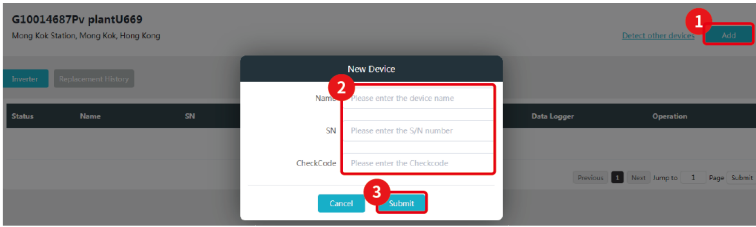

Figure 6.1-2 Add the Device

6.2 Check the PV Plant

Check the power generation status and equipment information via SEMS Portal after adding the equipment to the monitoring platform.

Step 1 : Enter <https://www.semsportal.com/Home/Login> , and log in using administrator/installers/guest account.

Step 2 : Click the plant name as figure 6.2-1 below.

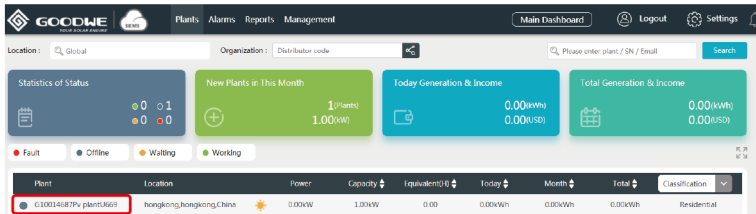

Figure 6.2-1 Check the PV Plant

Step 3 : Check the detailed information of the plant.

The screenshot displays a PV plant monitoring interface for plant ID G10018687PV plantU589. The system is currently **Offline**. Key performance indicators (KPIs) are shown as follows:

- Today Generation:** 0.00 kWh
- Today Income:** 0.00 USD
- Total Generation:** 0.00 kWh
- Total Income:** 0.00 USD

The dashboard also includes a weather forecast for the next five days:

Today	Wednesday	Thursday	Friday	Saturday
28°	21:28°	22:26°	22:26°	21:28°

Below the KPIs, there is a 'No Device' section with a table of system parameters:

Parameter	Value
Model	--
SN	--
Checksum	--
Capacity	-- kW
Connected	--
Power	-- kW
AC Voltage	-- V
AC Current	-- A
AC Frequency	-- Hz

On the right side, there is a 'Curve' section with a table of electrical parameters:

Parameter	Value
Boost Temperature	--
DC Voltage/Current1	-- V/A
DC Voltage/Current2	-- V/A
DC Voltage/Current3	-- V/A
DC Voltage/Current4	-- V/A
String Current1	-- A
String Current2	-- A
String Current3	-- A
String Current4	-- A
String Current5	-- A

The central part of the dashboard features a large circular gauge for 'Today Generation' showing 0 kWh. Below it, the status is 'Offline' and 'Total Generation' is 0 kWh. A 'Last Refresh Time' is also indicated.

6.1-3 Plant Information

Chapter VII : Technical Specifications



Introduce the technical indicators of EzLogger Pro.

Communication management

Communication	Inverter communication	3 x RS485
	PC communication	10/100M Ethernet
Number of managed devices	RS485	60 (The number of devices connected to a single RS485 port shall not exceed 20)
Communication distance	RS485	1000m (shielded twisted pair wire shall be used)
	Ethernet	100m

General parameters

General parameters	Power adapter	Input: 100 ~ 240Vac, 50/60Hz, Output: 12Vdc 1.0A/1.5A
	Power consumption	General 3W, maximum 6W
	Storage capacity	16MB, expandable to 8GB through an optional SD card
	Dimensions (L * W * H)	190*118*37mm
	Weight	500g
	Operating temperature	-20°C ~ +60°C
	Relative humidity (no condensation)	5% ~ 95%
	IP rating	IP20
	Installation method	Wall mounting, table surface mounting, rail mounting
Display	8 LED indicators	

Chapter VIII : Certification and Warranty

8.1 Certification Mark



8.2 Warranty Certificate

The users shall keep the product warranty card and purchase invoice properly in the product warranty period, and also keep the product nameplate legible; otherwise, GoodWe is entitled to refuse to provide quality warranty.

8.3 Warranty Conditions

On the premise that the product is used according to GoodWe User Manual, if any product failure occurs within the warranty period due to quality problems, GoodWe provides the following three ways of warranty according to the actual circumstances:

1. Return the product to the factory for maintenance.
2. On-site maintenance.
3. Product replacement (For discontinued products, it is allowed to replace with the product of equivalent value).

8.4 Disclaimer

The following circumstances are not covered by the warranty:

1. Product or parts have been beyond the warranty period (unless both Parties have signed an agreement for extension of warranty service). Failures or damage caused due to operation in violation of the product manual or relevant installation and maintenance requirements, unsuitable operating environment, improper storage, misuse, etc.
2. Damage caused due to insufficient ventilation. Failure or damage caused due to installation, repair, alteration or disassembly by any person other than GoodWe or the agents and personnel designated by GoodWe.
3. Failure or damage caused due to unforeseen factors, man-induced factors, force majeure or other similar reasons, and other failures or damage not due to GoodWe product quality problems.



Company Website



Company WeChat



340-00570-00

GOODWE (China)

No. 90 Zijin Rd., New District,
Suzhou, China
215001

Tel: +86(0)512 6958 2201
sales@goodwe.com
service@goodwe.com

GOODWE (Netherlands)

sales@goodwe.com.cn
service.nl@goodwe.com.cn

GOODWE (Australia)

sales@goodwe.com.cn
service.au@goodwe.com.cn

GOODWE (United Kingdom)

enquiries@goodwe.co.uk
service@goodwe.co.uk

Note: The above contact details are subject to change without notice. Please visit our company's official website www.goodwe.com.cn for details.