



Smart
connections.

Operating manual

PLENTICORE plus

Legal notice

KOSTAL Solar Electric GmbH
Hanferstraße 6
79108 Freiburg i. Br.
Germany
Phone +49 (0)761 477 44 - 100
Fax +49 (0)761 477 44 - 111
www.kostal-solar-electric.com

Exclusion of liability

All names, trademarks, product names or other designations used in this manual may be legally protected even if not indicated as such (e.g. as a trademark). KOSTAL Solar Electric GmbH assumes no liability or warranty for their free usage. The illustrations and texts have been compiled with great care. However, the possibility of errors cannot be ruled out. The compilation is made without any guarantee.

General note on gender equality

KOSTAL Solar Electric GmbH is aware of the importance of language with regard to the equality of women and men and always makes an effort to reflect this in the documentation. Nevertheless, for the sake of readability we are unable to use non-gender-specific terms throughout and use the masculine form instead.

© 2020 KOSTAL Solar Electric GmbH

All rights reserved by KOSTAL Solar Electric GmbH, including those of reproduction by photocopy and storage in electronic media. Commercial use or distribution of the texts, displayed models, diagrams and photographs appearing in this product is not permitted. This manual may not be reproduced, stored, transmitted or translated in any form or by means of any medium, in whole or in part, without prior written permission.

Valid from version:

User Interface (UI): 01.15.0000
Firmware (FW): 1.44

Contents

1. General information	6
1.1 Proper use	8
1.2 EU declarations of conformity	11
1.3 About this manual	12
1.4 Notes in this manual	14
1.5 Symbols used	18
1.6 Labels on the inverter	19
2. Device and system description	20
2.1 The photovoltaic system	21
2.2 The inverter	24
2.3 Functions	30
3. Installation	43
3.1 Transport and storage	44
3.2 Scope of delivery	45
3.3 Installation	46
3.4 Electrical connection	49
3.5 Overview of Smart Communication Board (SCB)	53
3.6 Connecting energy meter	54
3.7 Connecting the ripple control receiver	57
3.8 Connection for self-consumption control	60
3.9 Communication connection	61
3.10 Connecting battery	63
3.11 Closing the inverter	68
3.12 Connecting battery's DC cables	69
3.13 Connection of solar module	71
3.14 Initial commissioning	74
3.15 Configuring settings in the Webserver	78
4. Operation and operating the device	79
4.1 Switching on the inverter	80
4.2 Switching off the inverter	81
4.3 De-energising the inverter	82
4.4 Control panel	84
4.5 Operational status (display)	87
4.6 Operational status (LEDs)	90
4.7 The menu structure of the inverter	91

5.	Connection types	107
5.1	Connecting the inverter and computer	108
5.2	Settings on the computer	109
5.3	Connecting the inverter and computer	110
5.4	Disconnecting the inverter from the computer	112
5.5	Connection via KOSTAL Solar App	113
6.	Webserver	114
6.1	The Webserver	115
6.2	Calling up the Webserver	117
6.3	Menu structure of Webserver	119
6.4	Webserver menus	124
6.5	The battery use strategy	153
6.6	Smart battery control	155
7.	System monitoring	158
7.1	The log data	159
7.2	Retrieving, saving and graphically depicting log data	163
7.3	The KOSTAL Solar Portal	165
7.4	Remote service	166
8.	External battery control	167
8.1	External battery control	168
8.2	External battery control via Modbus (TCP)	169
8.3	External battery control via digital inputs	171
9.	Active power control	173
9.1	Why active power control?	174
9.2	Limitation of the PV feed-in capacity	175
9.3	Active power control with a ripple control receiver	176
9.4	Active power control using smart measuring systems	179
10.	Self-consumption control	182
10.1	Overview of self-consumption control	183
10.2	Connection for self-consumption control	184
10.3	Setting up self-consumption control	186

11. Maintenance	193
11.1 Maintenance and cleaning	194
11.2 Housing cleaning	195
11.3 Fan cleaning	196
11.4 Updating software	200
11.5 Event codes	202
12. Technical data	203
12.1 Technical data	204
12.2 Block diagram	209
13. Accessories	210
13.1 KOSTAL Solar Portal	211
13.2 KOSTAL Solar App	212
13.3 PIKO M2M Service	213
13.4 Activating battery connection	214
14. Appendix	215
14.1 Type plate	216
14.2 Warranty and service	217
14.3 Handover to the operator	218
14.4 Decommissioning and disposal	219
Index	220

1. General information

1.1	Proper use	8
1.2	EU declarations of conformity	11
1.3	About this manual	12
1.4	Notes in this manual	14
1.5	Symbols used	18
1.6	Labels on the inverter	19

Thank you for choosing an inverter from KOSTAL Solar Electric GmbH! We hope you enjoy consistently high energy yields with the inverter and your photovoltaic system.

If you have any technical questions, please call our service hotline:

- Germany and other countries¹
+49 (0)761 477 44 - 222
- Switzerland
+41 32 5800 225
- France, Belgium, Luxembourg
+33 16138 4117
- Greece
+30 2310 477 555
- Italy
+39 011 97 82 420
- Spain, Portugal²
+34 961 824 927

¹ Language: German, English

² Language: Spanish, English

1.1 Proper use

The inverter converts direct current into alternating current. This can be used as follows:

- For self-consumption
- For feed-in into the public grid
- For temporary storage in a battery storage system 

The device may only be used in grid-connected photovoltaic systems within the intended power range and under the permissible ambient conditions. The device is not intended for mobile use.

Inappropriate use may lead to injury or even death for the user or third parties. Material damage to the device and other equipment can also occur. The inverter may therefore only be used for its intended purpose.

All components fitted on the inverter or in the PV system must satisfy the standards and guidelines that apply in the country of installation.

The PLENTICORE plus battery inverter may only be used in conjunction with battery systems, which have been approved by KOSTAL Solar Electric GmbH for this type of inverter.



INFO

For battery storage to be connected to the inverter, DC input 3 must be released for battery use. To do this, an activation code must be entered in the inverter. The activation code can be purchased from the KOSTAL Solar online shop.  **Ch. 13.4**

Exclusion of liability

Any use that differs from that described in **Ch. 1.1** or goes beyond the stated intended purpose, is considered inappropriate. The manufacturer accepts no liability for any damage resulting from this. Modifications to the inverter are prohibited. The inverter may only be used if it is safe to operate and is in a technically perfect condition. Any instance of misuse will result in the termination of the warranty, guarantee and general liability of the manufacturer.

Only a qualified electrician may open the device. The inverter must be installed by a trained electrician (according to DIN VDE 1000-10 or BGV A3 accident prevention regulations or an internationally comparable standard) who is responsible for observing the applicable standards and regulations.

Work that could affect the electrical power system of the relevant energy supply company at the site of the solar power feed-in, may only be carried out by qualified electricians expressly authorised (licensed) by the energy supply company. This includes changes to the factory-preset parameters. The installer must always observe the regulations of the energy supply company.

Factory settings may only be changed by qualified electrical installers or persons with at least comparable or higher technical qualifications, e.g. foremen, technicians or engineers. When doing so, all requirements are to be observed.



IMPORTANT INFORMATION

The inverter may only be installed, maintained and repaired by a trained and qualified electrician.

The electrician is responsible for ensuring that the applicable standards and regulations are observed and implemented. Work that could affect the electrical power system of the relevant energy supply company at the site of the solar power feed-in, may only be carried out by qualified electricians expressly authorised (licensed) by the energy supply company.

This includes changes to the factory-preset parameters.

Open Source licence

This product contains Open Source software, developed by third parties and licensed using vehicles including GPL and/or LGPL.

For more details of this, a list of the Open Source software used and the related licence texts, go to the Licences section on the inverter's website (Webserver)

 **Ch. 6.**

1.2 EU declarations of conformity

KOSTAL Solar Electric GmbH hereby declares that the inverter described in this document complies with the basic requirements and other relevant conditions of the directives listed below.

- Directive 2014/30/EU
(on the approximation of the laws of the Member States relating to electromagnetic compatibility (EMC))
- Directive 2014/35/EU
(on the harmonisation of the laws of the Member States relating to the making available on the market of electrical equipment designed for use within certain voltage limits – in short: Low Voltage Directive)
- Directive 2011/65/EU (RoHS)
on the restriction of the use of certain hazardous substances in electrical and electronic equipment

You will find a detailed EU Declaration of Conformity in the download area at:

www.kostal-solar-electric.com

1.3 About this manual

Read this manual carefully in its entirety.

It contains important information on the installation and operation of the inverter. Pay particular attention to the instructions regarding safe usage. KOSTAL Solar Electric GmbH assumes no liability for damages arising from the non-observance of this manual.

This manual is an integral part of the product. It applies exclusively to the inverters from KOSTAL Solar Electric GmbH. Keep this manual and give it to the new owner should you pass it onto a new operator.

The installer and the operator must have unrestricted access to these instructions at all times. The installer must be familiar with this manual and follow all instructions.

The most recent version of the operating manual for your product is available in the download area at www.kostal-solar-electric.com.

Target group

This manual is intended for trained and qualified electrical technicians who install, maintain and repair the inverters.

The inverters described in this manual differ from one another in terms of particular technical details. Information and handling instructions that only apply to certain device types, are to be identified accordingly.

Information concerning your safety or that of the unit is specifically noted.

Navigation through the document

In order to enable navigation through this document, it contains clickable areas.

One of these is the navigation bar in the header of each page. By clicking here, you are taken to the overview pages of the individual chapters.

The table of contents can also be used in this way: From the index at the beginning of each chapter you can go to the indicated sub-chapter in one click.

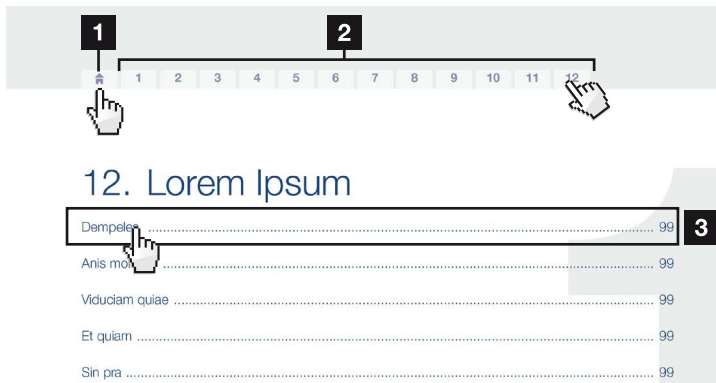

Fig. 1: Navigation through the document

- 1 Calling up the main table of contents
- 2 Navigation bar
- 3 Tables of contents

You can navigate to the referenced points in the document within the instruction text using the cross-references.

- 🔗 Ch. 1
- 🔗 Fig. 1, It. 2

Fig. 2: Examples of cross-references

1.4 Notes in this manual

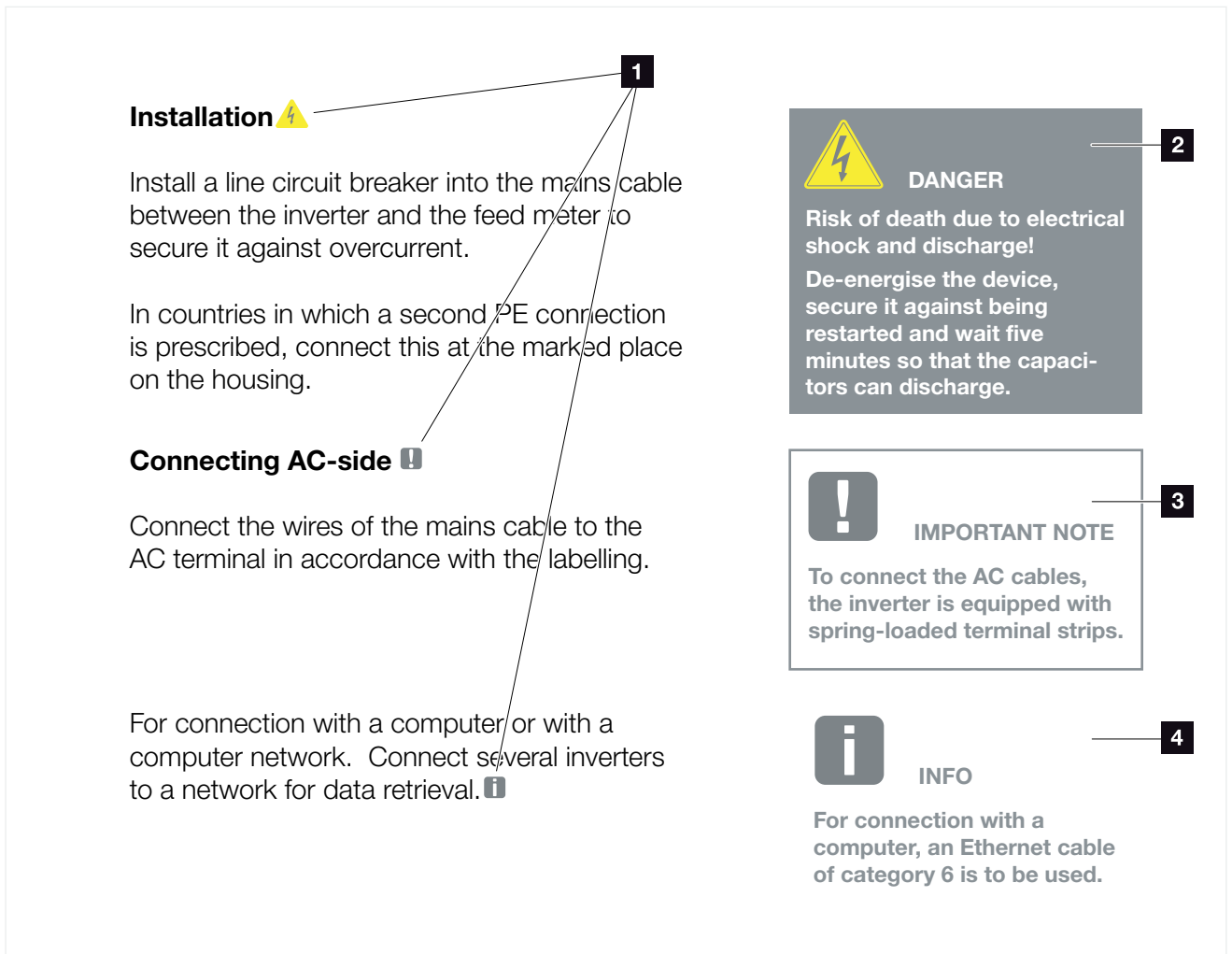

Fig. 3: Safety instructions in this manual

- 1 Reference icon within the instruction text
- 2 Warning
- 3 Information note
- 4 Other notes

Notes have been incorporated into the instruction text. A differentiation is made in this manual between warnings and information notes. All notes are identified in the text line with an icon.

Warnings

The warnings refer to life-threatening dangers. Serious injuries possibly resulting in death may occur.

Each warning consists of the following elements:

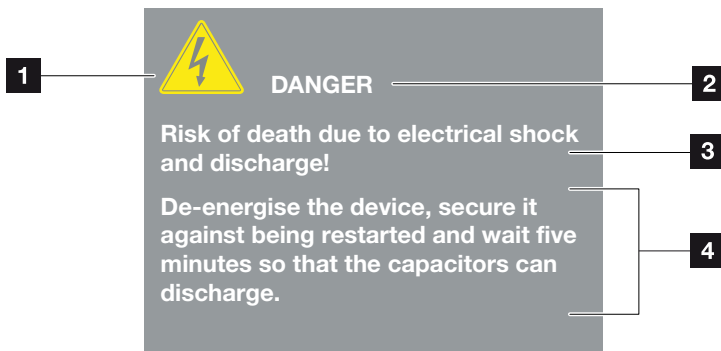

Fig. 4: Structure of the warnings

- 1** Warning symbol
- 2** Signal word
- 3** Type of danger
- 4** Corrective actions

Warning symbols



Danger



Danger due to electrical shock and discharge



Danger due to burns

Signal words

Signal words are used to identify the severity of the danger.

DANGER

Indicates a direct hazard with a high level of risk, which, when it is not avoided, may result in death or serious injury.

WARNING

Indicates a hazard with a moderate level of risk, which, when it is not avoided, may result in death or serious injury.

CAUTION

Indicates a hazard with a low level of risk, which, when it is not avoided, may result in minor or slight injury or property damage.

Information notes

Information notes contain important instructions for the installation and problem-free operation of the inverter. These must be followed at all times. The information notes also point out that failure to observe can result in damage to property or financial damages.

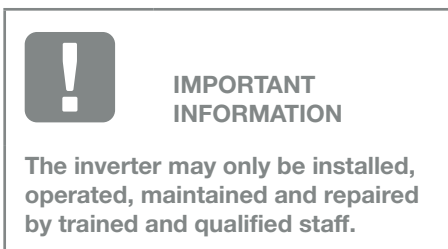

Fig. 5: Example of an information note

Symbols within the information notes



Important information



Damage to property possible

Other notes

They contain additional information or tips.



INFO

This is additional information.

Fig. 6: Example of an information note

Symbols within the additional notes



Information or tip



Enlarged view

1.5 Symbols used

Symbol	Meaning
1., 2., 3. ...	Sequential steps in a handling instruction
→	Effect of a handling instruction
✓	Final result of a handling instruction
↗	Cross-reference to other places in the document or to other documents
■	List

Tab. 1: Symbols and icons used





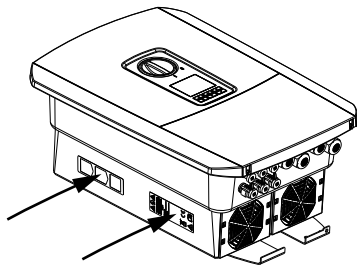

Abbreviations used

Abbrevia- tion	Explanation
Tab.	Table
Fig.	Figure
It.	Item
Ch.	Chapter

1.6 Labels on the inverter



Signs and labels are applied to the housing of the inverter. These signs and labels may not be altered or removed.

Symbol	Explanation
	Danger due to electrical shock and discharge
	Danger due to burns
	Danger notice
	Danger due to electrical shock and discharge. Wait five minutes (discharge time of the capacitors) after shut-down
	Additional earth connection
	Observe and read operating manual
	Device may not be disposed of with household waste. Observe the local application of disposal requirements
	CE marking The product satisfies the applicable EU requirements

2. Device and system description

2.1	The photovoltaic system	21
2.2	The inverter	24
2.3	Functions	30



2.1 The photovoltaic system

Inverter with 3 PV inputs

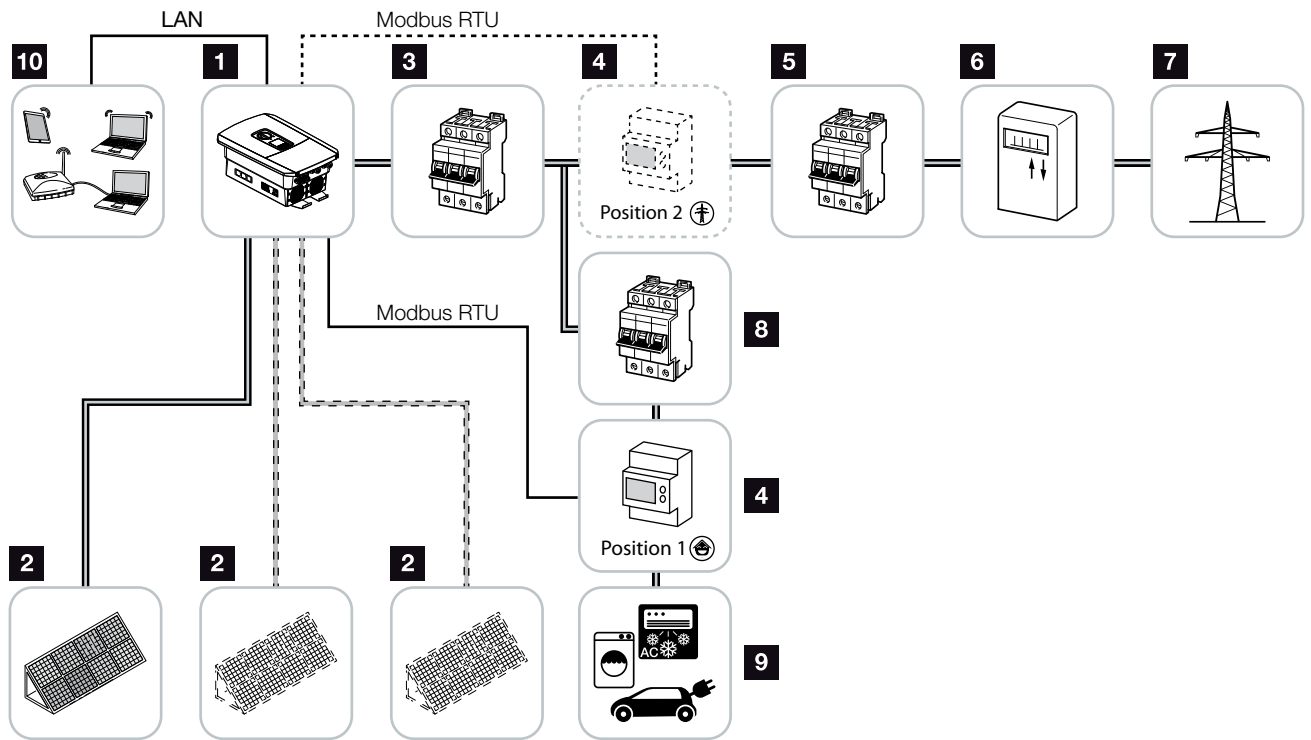

Fig. 7: Photovoltaic system with 3 PV inputs

- 1** Inverter
- 2** PV generators (number depends on the type)
- 3** Line circuit breaker for inverter
- 4** Digital energy meter (Modbus RTU) grid connection (position 2) or home consumption (position 1). Position 1 should be the preferred option because this provides more accurate home consumption values.
- 5** Main fuse building
- 6** Feed-in procurement meter or smart meter (not in all countries)
- 7** Public grid
- 8** Line circuit breaker for energy consumers
- 9** Energy consumers
- 10** Communication link for inverter

Inverter with 2 PV inputs and 1 DC battery connection

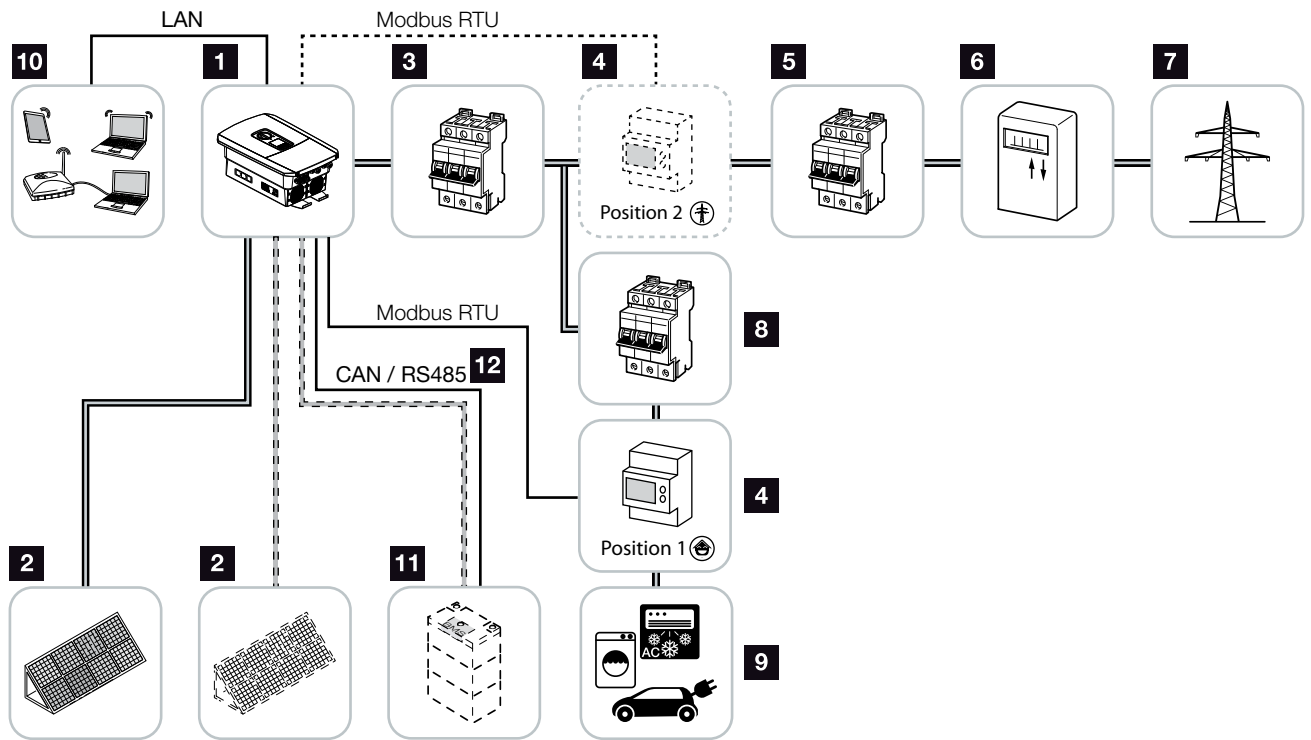

Fig. 8: Photovoltaic system with PV and battery connection

- 1** Inverter
- 2** PV generators (number depends on the type)
- 3** Line circuit breaker for inverter
- 4** Digital energy meter (Modbus RTU) home consumption (position 1) or grid connection (position 2). Position 1 should be the preferred option because this provides more accurate home consumption measuring values.
- 5** Main fuse building
- 6** Procurement and feed meter or smart meter (not in all countries)
- 7** Public grid
- 8** Line circuit breaker for energy consumers
- 9** Energy consumers
- 10** Communication link for inverter
- 11** Connection for battery system (available as option after activation)
- 12** Communication connection for battery management system (BMS) via CAN or RS485

Inverter with extra AC power source

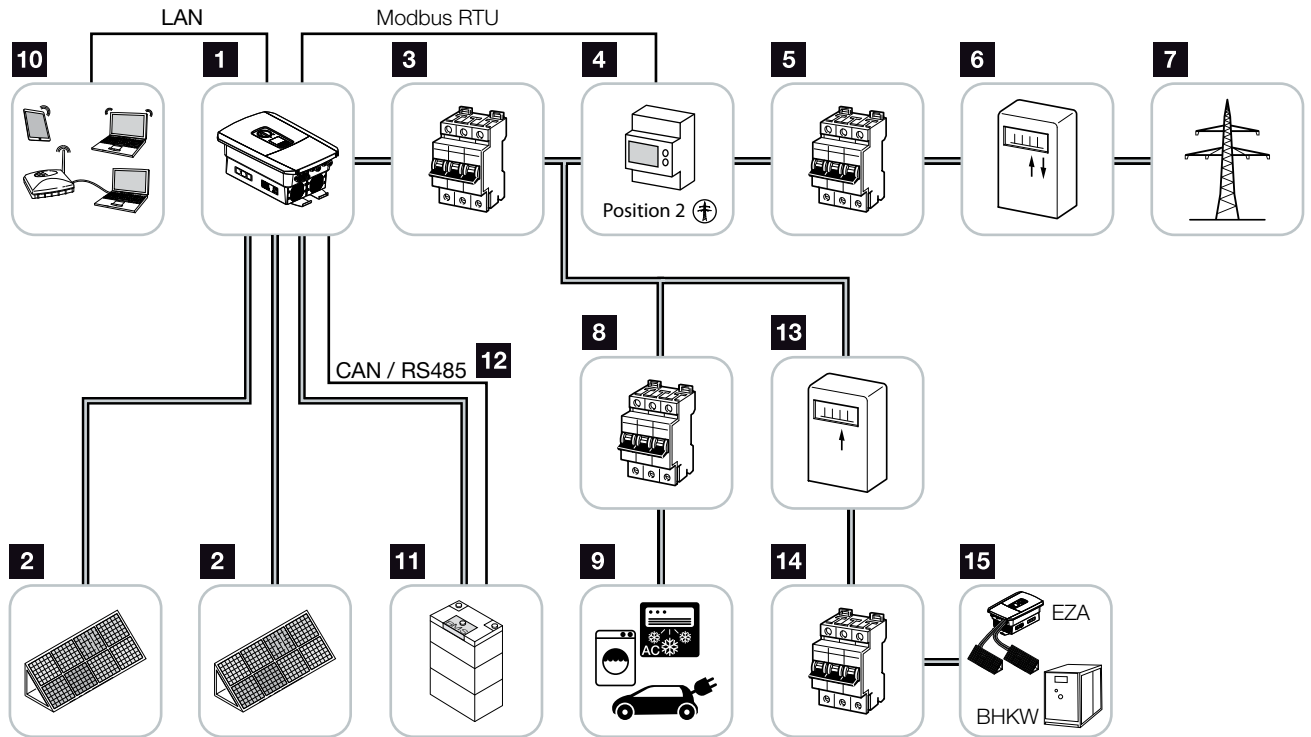

Fig. 9: Photovoltaic system with AC power source

- 1** Inverter
- 2** PV generators (number depends on the type)
- 3** Line circuit breaker for inverter
- 4** Digital energy meter (Modbus RTU)
- 5** Main fuse building
- 6** Procurement and feed meter or smart meter (not in all countries)
- 7** Public grid
- 8** Line circuit breaker for power consumption
- 9** Power consumption
- 10** Communication link for inverter
- 11** Connection for battery system (available as option after activation)
- 12** Communication connection for battery management system (BMS) via CAN or RS485
- 13** Feed meter for AC power source
- 14** Line circuit breaker for AC power source
- 15** AC power source, e.g. CHP plant or other generation plants, such as PV inverter (the energy from the AC power source can be put into intermediate storage in the battery)

2.2 The inverter

Exterior view of the inverter

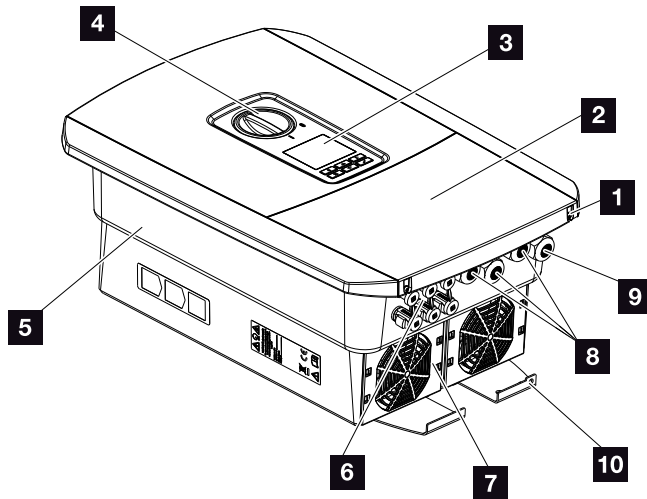

Fig. 10: Inverter (exterior view)

- 1 Cover screws
- 2 Cover (terminal compartment)
- 3 Display
- 4 DC switch
- 5 Housing
- 6 Plug connector for connecting the PV generators and battery system (battery connection only available after activation)
- 7 Fan
- 8 Cable openings for communication
- 9 Cable opening for mains cable
- 10 Additional PE connection, outside

DC switch on the inverter

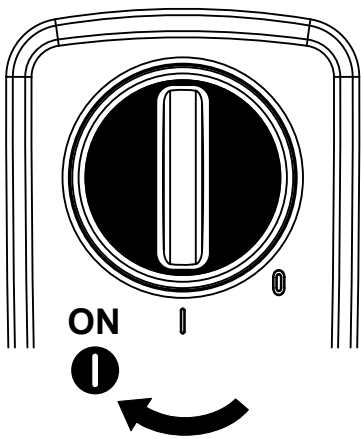

Fig. 11: DC switch ON

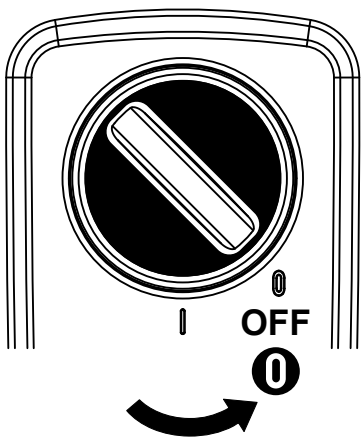

Fig. 12: DC switch OFF

The terminal compartment

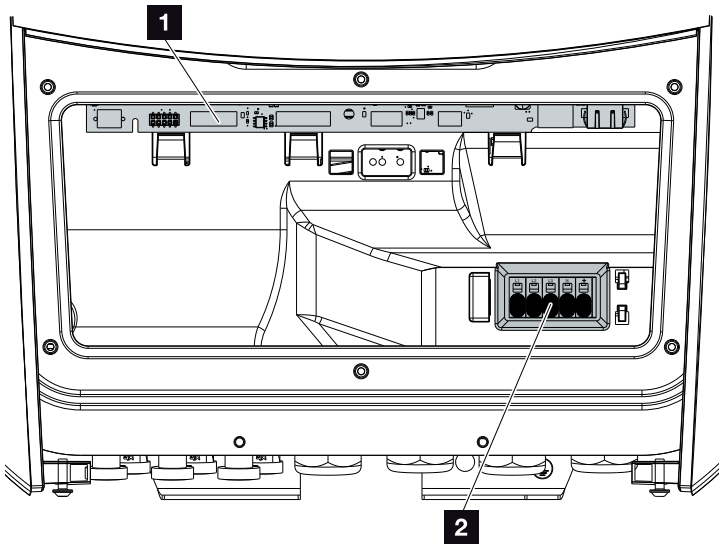
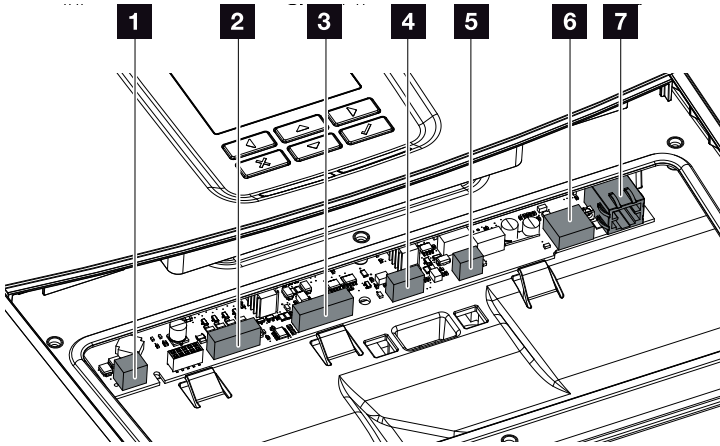

Fig. 13: Inverter (interior view)

- 1** Smart Communication Board (SCB)
- 2** AC terminal

Smart Communication Board (SCB)



Inverter (interior view)

- 1** Terminal for self-consumption control (connection of consumers via external load relay)
- 2** Terminal for digital interface for ripple control receiver/ external battery control
- 3** Terminal for battery communication via RS485 or CAN
- 4** Not used
- 5** Terminal for energy meter (Modbus RTU)
- 6** USB 2.0 port
- 7** Ethernet connection (RJ45) LAN

The Smart Communication Board (SCB) is the inverter's communication hub. All the connections for communicating with other components can be found on the SCB.

The control panel

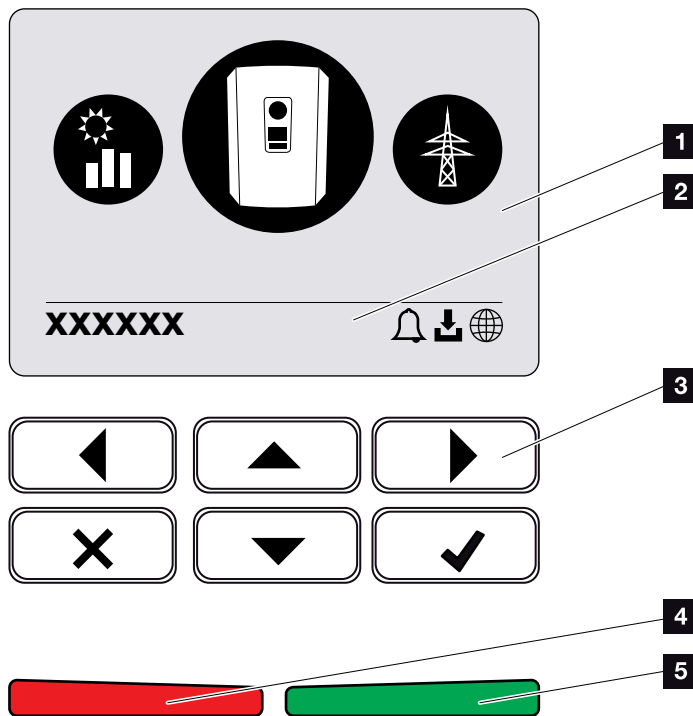







Fig. 14: Control panel

- 1** Display
- 2** Status line, alternating
(inverter status, event code, IP address, status of solar portal connection, updates available, events)
- 3** Control buttons
- 4** Red status LED for events
- 5** Green status LED for feed-in mode

Adjustments can be made and data retrieved via the control panel.

The inverter menus

The inverter provides the following menu items for querying statuses and configuring the inverter:

Symbol	Function
	PV power status query
	Status query for AC feed-in power and grid parameters of public grid
	Home consumption status query
	Battery power status query
	Inverter configuration

Tab. 2: Inverter menus



INFO

There may be deviations depending on the software version. .

2.3 Functions

Energy management system

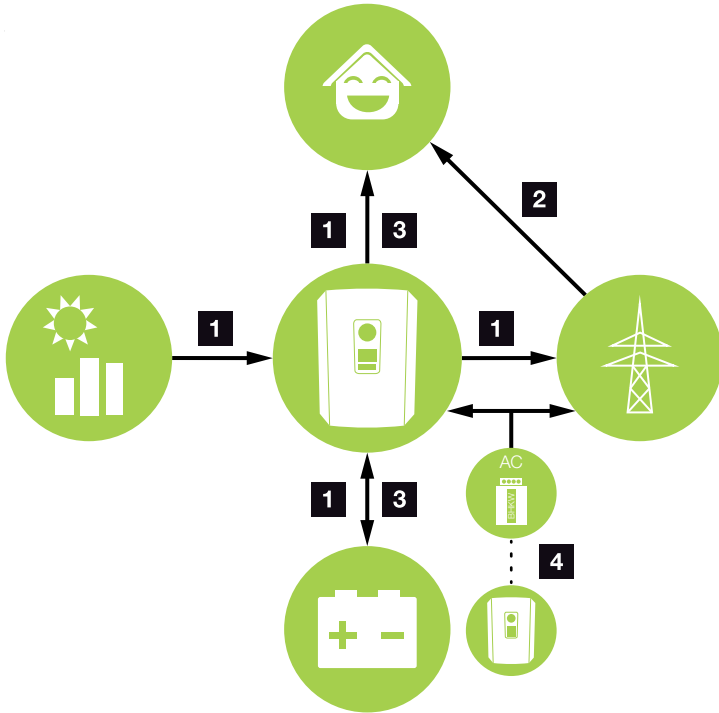

Fig. 15: Control and distribution of the energy flows

1 PV energy:

- Energy supply for local consumers
- For charging the battery
- Feed-in to the public grid

2 Battery energy:

- Energy supply for local consumers
- Feed in to the public grid
(only possible via external battery managers)

3 Grid energy:

- Energy supply for local consumers
- For charging the battery from the public grid, e.g. to protect the battery in winter or via external battery control/battery managers.

4 AC power sources:

- Energy supply for local consumers
- For charging the battery
- Feed-in to the public grid **i**



INFO

Potential AC power sources include combined heat and power (CHP) units, other inverters or energy sources. In order to store this energy in a connected battery, this function must be activated in the Webserver "Webserver menu - Service menu - General" on page 136.

The energy management system (EMS) controls the distribution of the energy between the DC side (PV generator) and the AC side (building grid, public grid). For this purpose, the EMS checks for the presence of consumption in the internal house grid. The logic of the EMS then calculates and controls the optimal usage of PV energy. Priority is given to use by self-consumers of the PV energy generated. The remaining generated PV energy is fed into the grid and remunerated.

Recording home consumption

Connecting up an external energy meter (via Modbus RTU) enables the inverter to monitor the flow of energy in the home for 24 hours and to control it in an optimum manner.

The generated PV energy is primarily used for consumers (such as light, washing machine or television). The energy generated above and beyond this can be stored temporarily in a battery storage device or fed into the public grid. 

For more information  **Ch. 3.6**

- Using energy meter (Modbus RTU) to record home consumption
- 24-hour measurement
- Various types of energy meter can be used 



INFO

For battery storage to be connected to the inverter, DC input 3 must be released for battery use. To do this, an activation code must be entered in the inverter. The activation code can be purchased from the KOSTAL Solar online shop.  **Ch. 13.4**



INFO

You will find a list of the approved energy meters in the download area for the product on our homepage.

Storing energy

If external battery storage is connected to the DC input 3 on the inverter (can be released using the battery activation code), the generated PV energy can be stored and accessed later on for self-consumption.

- The connection and battery use at the DC input 3 on the inverter must be released beforehand in the inverter. To do this, the battery activation code can be purchased from the KOSTAL Solar online shop.
- Various battery storage systems (various manufacturers) can be connected to the PLENTICORE plus. You will find a list of approved KOSTAL Solar Electric battery storage systems on our homepage in the download area for the product.
- Various scenarios for the battery use strategy can also be selected on the Webserver, allowing the system to be matched to your requirements.
- By using the smart generation and consumption forecast, usage of the generated energy is optimised (in addition to the simple process of storing power) and all power limitations stipulated by law are satisfied at the same time.

Shadow management

If a connected PV string is subjected to partial shading, e.g. caused by other parts of a building, trees or power lines, the entire PV string no longer achieves its optimum performance. The PV modules affected behave like a bottleneck and thereby prevent better performance.

The intelligent shadow management integrated in the inverter now adapts the MPP tracker of the selected string so that the PV string can always deliver optimum performance in spite of partial shading.

Shadow management can be activated via the Webserver.  **Ch. 6**

Communication

The inverter provides various interfaces for communication purposes. These establish a connection to other inverters, sensors, energy meters, batteries or a link to the Internet.

- LAN
LAN connects the inverter to the local home network via which it can then access the Internet and solar portal.
- RS485/Modbus (RTU)
Energy meters are connected to the Modbus interface and record the flow of energy within the house.

Secure communication

These days, secure data transfer is an important element of all devices linked to the Internet. All the data transferred externally from the inverter is of course only transferred in an encrypted manner.

- Security concept
Encrypted transfer of data to the solar portal
- Data encryption in line with AES and SSL standards

Ripple control receiver / smart meter

Once the system reaches a certain size, which may vary from one country to the next, the use of a ripple control receiver is mandatory. In some instances, the energy provider also requires a smart meter to be installed.

Contact your energy provider for more information.

If a smart meter gateway is fitted in your house installation, the inverter can be connected to the smart meter gateway using a control box. The control box is connected to the inverter like a ripple control receiver.

- Connection facility for ripple control receivers
- Connection facility for a control box for communicating with a smart meter gateway

For more information  **Ch. 9**

Self-consumption control

To make the best possible use of the PV energy generated, self-consumption should be prioritised. To do this, the inverter allows consumers to be connected to it via an external relay. The consumers can then be switched on when there is sufficient PV power and thereby access the PV energy generated at that point in time.

For more information  **Ch. 10**

External battery control

The inverter has a charge/discharge management system that can be configured via the Webserver in the “Battery Settings” service menu. Among other things, the external battery control can be activated here, which then implements the specifications of your energy supplier or other service provider, for example.

Via the external battery management, the external supplier has access to the charge/discharge management of the inverter and can control it in such a way that the battery energy can be used e.g. for home consumption or in such a way that the battery energy is fed into the public grid in order to use it e.g. for grid stabilisation (load peaks in the grid (peak shaving)) or to provide grid services (primary control power). 



INFO

The system installer is responsible for the correct selection and installation of the meter structure in the house grid. The specifications of the energy supplier must be observed in this case.

The Webserver

The Webserver is the graphic interface (displayed in the browser e.g. Firefox, Internet Explorer or Google Chrome) for querying and configuring the inverter.

The Webserver provides the following functions:

- Logging into the inverter
- Querying the inverter status
- Current yield values of PV generators
- Current consumption values
- Current values of grid connection (e.g. feed-in, purchase)
- Statistics
- Use of the self-consumption terminal
- Display of log data
- Display of inverter version status (e.g. UI, FW, HW)
- Configuring the inverter (e.g. software update, releasing options, battery configuration, changing inverter settings which have been specified by the energy provider etc.)

For more information  **Ch. 6**

The data logger

A data logger is integrated in the inverter. The data logger is a data storage system, which collects and stores the yield and performance data of the inverter and the storage system. Yield data is saved (saving interval) every 5 minutes. 

Saving interval	Saving time
5 minutes	Max. 365 days

Tab. 3: Saving intervals of data logger

For further information  **“Making settings in the Webserver” on page 118.**



INFO

Once the storage time has expired, the oldest data is always deleted.

For long-term backup, the data must be backed up with a PC or sent to a solar portal.

KOSTAL Solar Portal

The KOSTAL Solar Portal protects your investment in a PV system against yield loss, e.g. through active e-mail alerts of events.

You can log into the KOSTAL Solar Portal for free at www.kostal-solar-portal.com.

Functions include:

- Worldwide online access to the portal
- Graphic representation of the power and yield data
- Visualisation of data and thus being made aware of how to optimise self-consumption
- Notification of events by e-mail
- Data export
- Sensor evaluation
- Display and proof of a potential active power reduction by the grid operator
- Storage of log data for long-term and reliable monitoring of your PV system
- Provision of system data for the KOSTAL Solar App

Additional information about this product is available on our website www.kostal-solar-electric.com at **Products > Monitoring software > KOSTAL Solar Portal**.

Event codes

Should an event or fault occur during operation, it is indicated on the inverter display and stored in the inverter and solar portal (only if connected).

For further information  **Ch. 11.5.**

Service concept

The inverter includes smart monitoring. Should an event occur during operation, an event code for this is shown in the display.

As the operator of the system, in the event of a service call-out, you can then read out the message and obtain assistance from your installer or service partner.

For further information  **Ch. 7.4.**

KOSTAL Solar Plan configuration software

Our free KOSTAL Solar Plan software simplifies the inverter layout process.

Just enter the system data and individual customer data and receive a recommendation for a KOSTAL solar inverter tailored to the planned solar system. All KOSTAL solar inverters are considered for this. The customer's power consumption is also considered and, using standard load profiles, the potential for self-consumption and self-sufficiency is indicated.

The KOSTAL Solar Plan covers the following areas of inverter layout:

- **Rapid layout**
Manual inverter layout taking account of the inverter specifications
- **Layout**
Automatic inverter layout with the option of taking power consumption into account
- **Storage layout**
Automatic battery inverter layout with the option of taking power consumption into account

Alongside enhanced inverter layout, the KOSTAL Solar Plan also helps you to produce quotations. Customer, project and installer data is added to the technical data entered by the user, then included with the quotation as a PDF overview. What's more, the planning data can also be saved in a project file and edited if required.

You can find additional information about this product on our website www.kostal-solar-electric.com in the section **Installer portal**.

3. Installation

3.1	Transport and storage	44
3.2	Scope of delivery	45
3.3	Installation	46
3.4	Electrical connection	49
3.5	Overview of Smart Communication Board (SCB)	53
3.6	Connecting energy meter	54
3.7	Connecting the ripple control receiver	57
3.8	Connection for self-consumption control	60
3.9	Communication connection	61
3.10	Connecting battery	63
3.11	Closing the inverter	68
3.12	Connecting battery's DC cables	69
3.13	Connection of solar module	71
3.14	Initial commissioning	74
3.15	Configuring settings in the Webserver	78

3.1 Transport and storage

The function of the inverter has been tested and it has been carefully packaged prior to delivery. Upon receipt, check the delivery for completeness and any transport damage. 📦

Complaints and damage claims are to be directly addressed to the shipping company.

If stored for a longer period before installation, all inverter components must be kept dry and dust-free in the original packaging.

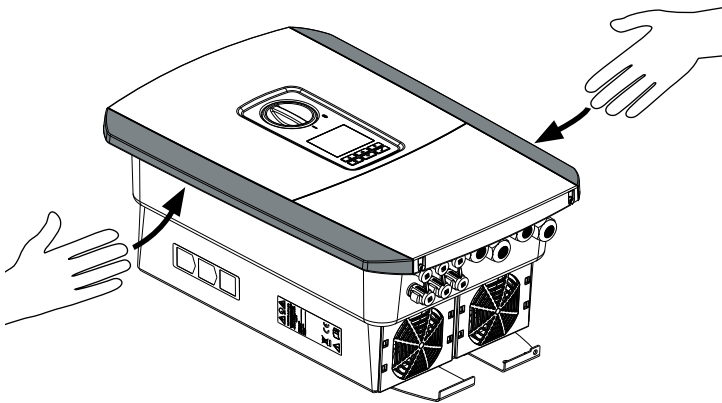

Fig. 16: Grip strips on inverter

For enhanced inverter transport, use the grip strips on the left and right side of the inverter.



DAMAGE POSSIBLE

Potential risk of damage when putting down the inverter. Whenever possible, place the inverter on its back after unpacking.

3.2 Scope of delivery

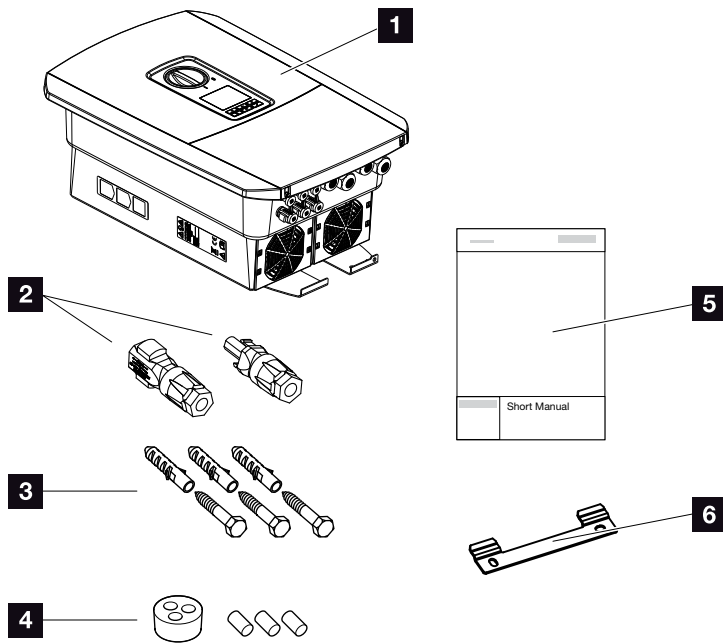

Fig. 17: Scope of delivery

The packaging contains:

- 1** Inverter
- 2** DC plug connector
(each DC input: 1× plug, 1× socket)
- 3** 3 x screws 6x45 with S8 screw anchors
- 4** Plug seals for screw connection of network cable
- 5** Short manual
- 6** Wall mount

3.3 Installation

Selecting the installation site



Protect inverter against exposure to direct sunlight.



Protect inverter from rain and splash water.



Protect inverter from falling parts which could enter the inverter's ventilation openings.

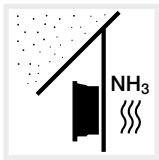

Protect the inverter against dust, contamination and ammonia gases. Rooms and areas containing livestock are not permitted as installation sites.

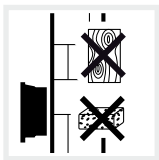

Mount inverter on a stable installation surface that can safely bear the weight. Plasterboard walls and wood planking are not permitted.



Mount inverter on a non-flammable installation surface. 

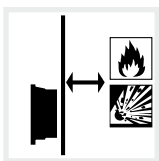

A sufficient safety distance from flammable materials and potentially explosive areas in the vicinity must be ensured.



IMPORTANT INFORMATION

Observe these instructions when selecting the installation site. Guarantee claims may be restricted or become entirely null and void in the event of failure to observe.



WARNING

RISK OF BURNS FROM HOT PARTS ON THE INVERTER!

Some of the inverter components can reach temperatures of over 80°C during operation. Select the installation site in accordance with the information provided in these instructions. Always keep the ventilation openings clear.



Inverters can cause noise when in operation. Install inverter in such a way that people are not disturbed by operation noises.

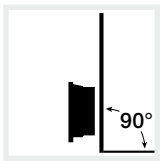

Mount inverters on vertical installation surfaces.

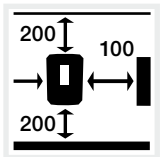

Maintain minimum distances and the necessary clearance.



Inverter may only be installed up to an altitude of 2000 m.

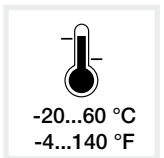

The ambient temperature must be between -20 °C and +60 °C.



The air humidity must be between 4 % and 100 % (condensing).



Install inverters so that they are not accessible to children.

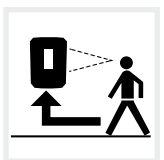

Inverters must be easily accessible and the display clearly legible.

Wall mounting ! !

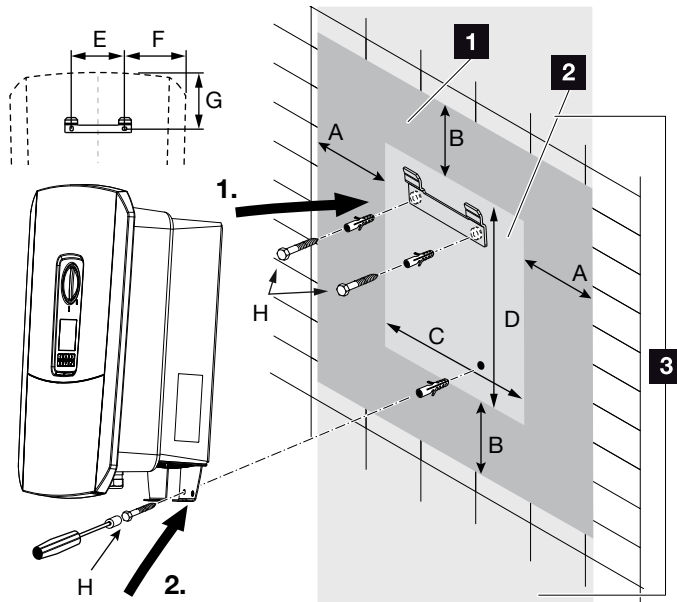

Fig. 18: Wall mounting with wall mount

- 1** Clearance
- 2** Outer dimensions of the inverter
- 3** Inverters may not be installed in this area

You can find the distances for wall mounting in the following table:

Dimensions in mm (inch)							
A	B	C	D	E	F	G	H
100 (3.9)	200 (7.9)	405 (15.94)	563 (22.17)	122 (4.8)	141 (5.55)	128 (5.04)	min. DIN571 A2-70 6x45

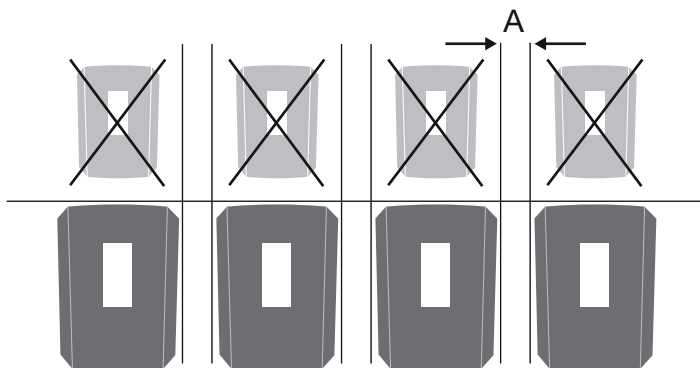

Fig. 19: Wall mounting of several inverters



IMPORTANT INFORMATION

Be absolutely sure to maintain the clearance around the inverter in order that the inverter remains cool.



IMPORTANT INFORMATION

To install the inverter, use the wall mount with 2 retaining bolts (included in scope of delivery) suitable for the existing base.

Fix the inverter to the wall at the bottom using a 3rd bolt (included in scope of delivery).

3.4 Electrical connection

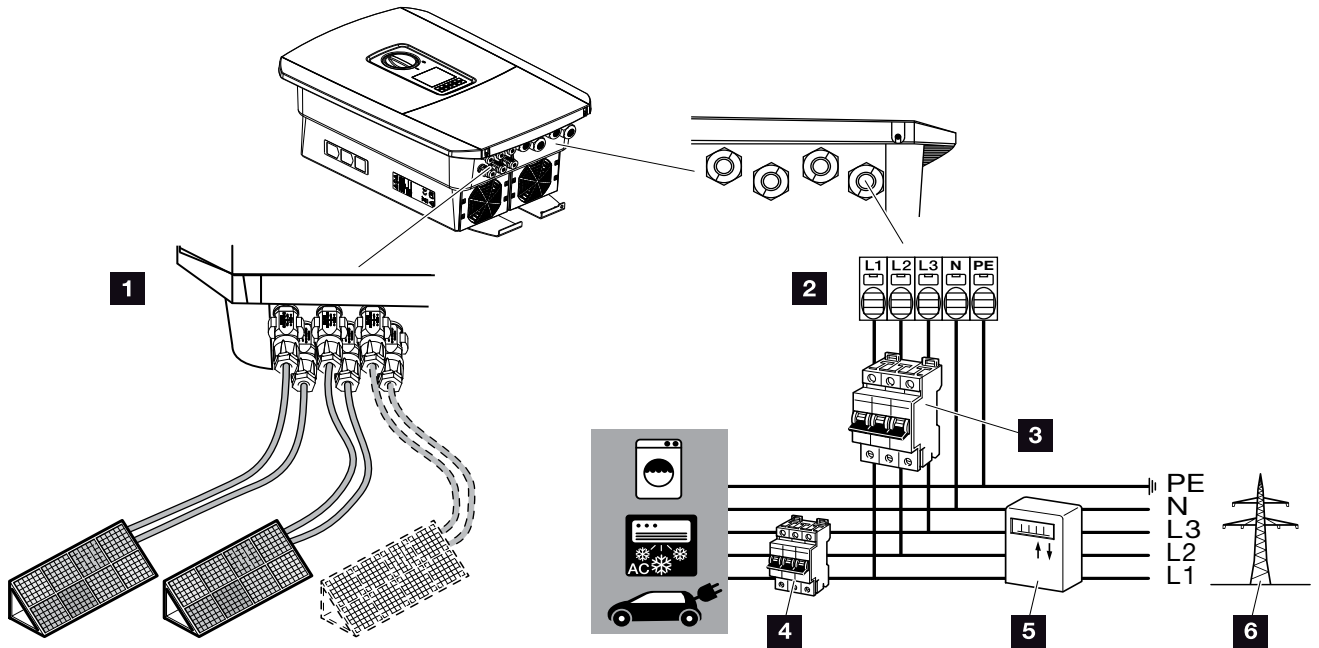



Fig. 20: Overview of electrical connections

Inverter connections

- 1 DC connections
- 2 AC terminal 

External connections

- 3 Line circuit breaker for inverter
- 4 Line circuit breaker for consumers
- 5 Energy meter
- 6 Public grid



IMPORTANT INFORMATION

Ensure that the phases of the AC terminal and the phases in the house grid are assigned uniformly.



IMPORTANT INFORMATION

A type A RCD ≥ 300 mA can be used on the AC side as residual current protection equipment (RCD). Compatibility with a type A RCD is set in the Webserver by going to Service menu > External hardware settings > Residual current protection equipment. (Default setting: compatible with type A RCD).

Connecting mains cable

1. De-energise the house grid. ⚠
2. Secure home fuses against reactivation.
3. Move DC switch on inverter to “Off” position.
➡ Fig. 12
4. Remove screws on bottom cover and take off cover. ⚠

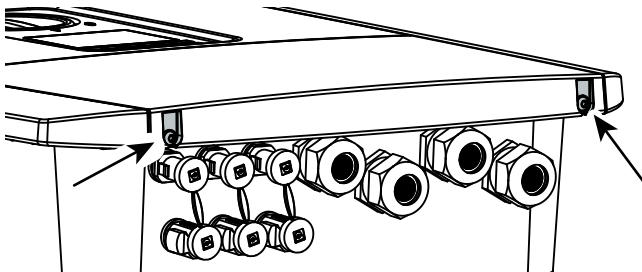

Fig. 21: Taking off cover

5. Remove screws of terminal compartment and take off cover.

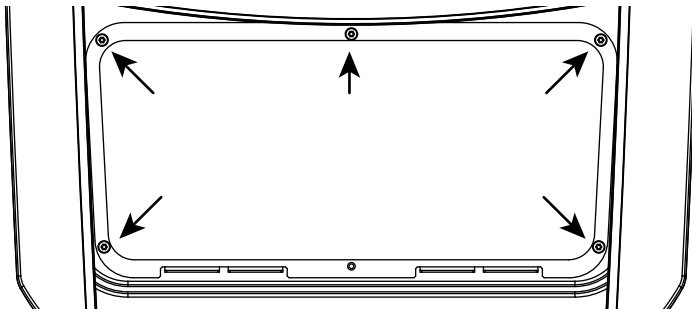

Fig. 22: Taking off terminal compartment cover



DANGER

RISK OF DEATH DUE TO ELECTRICAL SHOCK AND DISCHARGE!

De-energise all devices and secure them against being switched on again.



IMPORTANT INFORMATION

Whenever working inside the inverter, only ever use insulated tools to prevent short-circuits.

6. Correctly lay the mains cable from the power distributor to the inverter. **!**

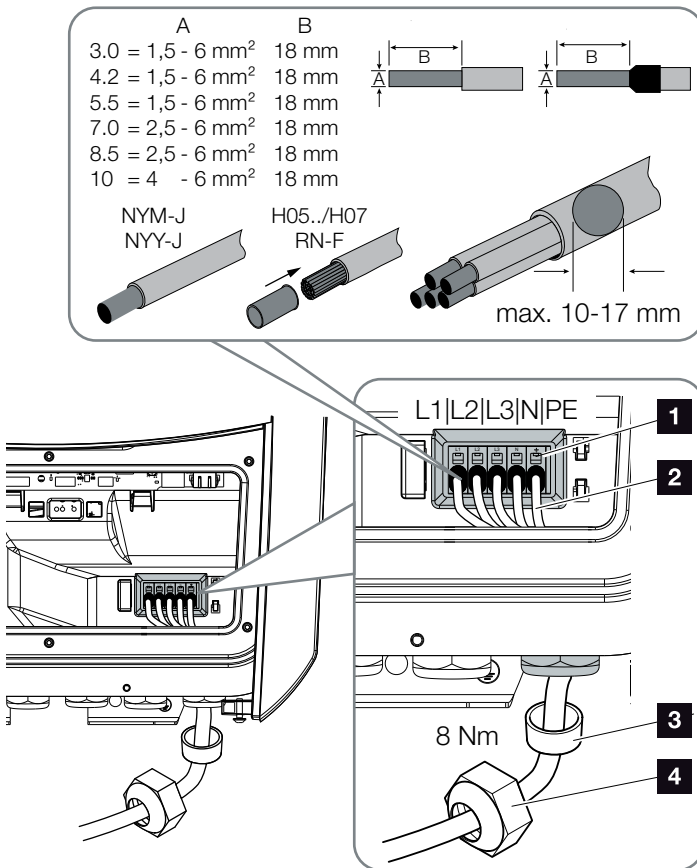

Fig. 23: Connecting mains cable to the inverter

- 1** AC terminal
 - 2** Mains cable
 - 3** Sealing ring
 - 4** Union nut
7. Insert mains cable into the inverter and seal with sealing ring and union nut. Tighten union nut to the prescribed torque. Torque: 8 Nm (M25).
8. When threaded connections are not used, leave the sealing ring in the threaded connections.





IMPORTANT INFORMATION

See the “Technical Data” chapter for the dimensioning of the required AC line circuit breaker. **!** Ch. 12.1

Single-wire cables (type NY-Y or NYM-J) without core end sleeves can be used with the AC terminal.

When using cables with fine wires (type H05../H07RN-F), core end sleeves should be used. Ensure that there is a contact surface of 18 mm.

9. Connect the wires of the mains cable to the AC terminal in accordance with the labelling.   Fig. 23, It. 1

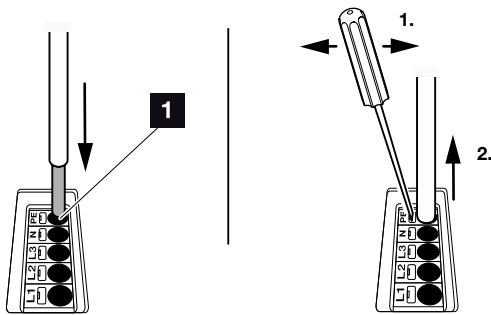





Fig. 24: Spring-loaded terminal strip

10. Install a line circuit breaker in the mains cable between the inverter and the feed meter to protect it against overcurrent.  

11. In countries in which a second PE connection is prescribed, connect this at the marked place on the housing (outside).

 Fig. 25, It. 1

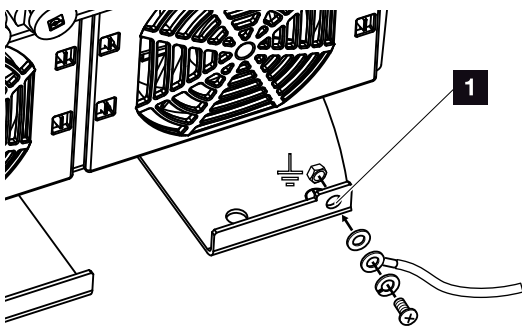

Fig. 25: Country-specific PE connection, outside

- ✓ The AC connection is connected.



IMPORTANT INFORMATION

To connect the AC cables, the inverter is equipped with spring-loaded terminal strips. The wires should be inserted into the large round openings (It. 1) of the terminal. The wire stripping length is 18 mm. Core end sleeves should be used with stranded cables.



WARNING

RISK OF FIRE DUE TO OVER-CURRENT AND HEATING OF THE MAINS CABLE!

Install line circuit breaker to secure against overcurrent.



IMPORTANT INFORMATION

This product may generate a direct current in the outer protective earthing conductor. A type A or B RCD ≥ 300 mA can be used on the AC side as residual current protection equipment (RCD). Use of a type A RCD is approved in the Webserver by going to Service menu > External hardware settings > Residual current protection equipment. (Default setting: type A RCD released).

3.5 Overview of Smart Communication Board (SCB)

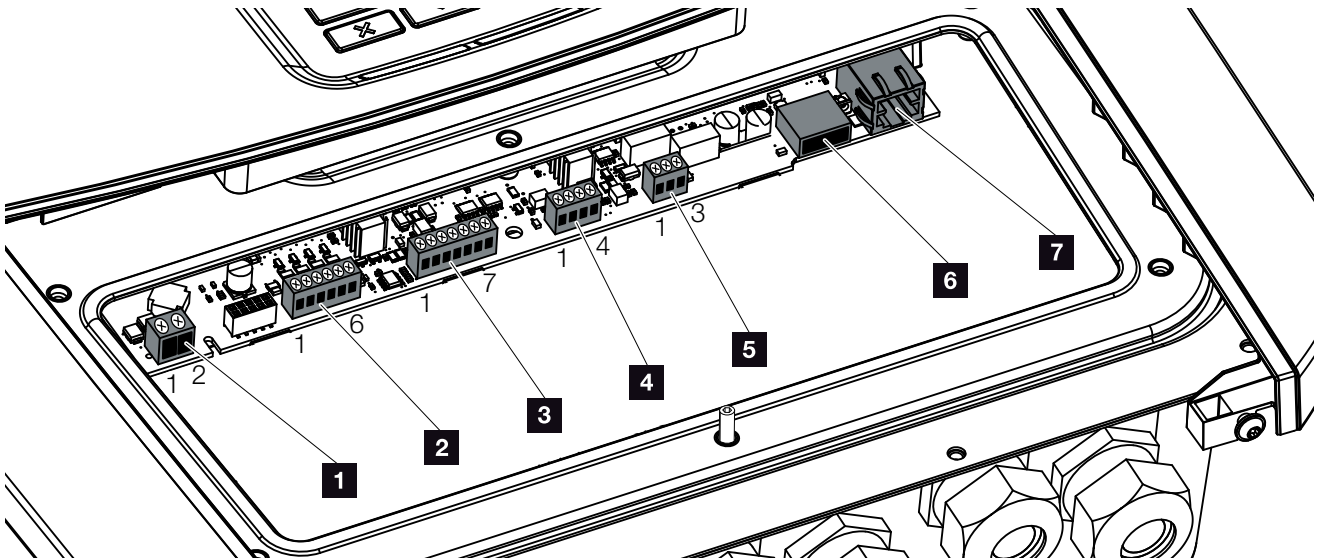

Fig. 26: Smart Communication Board - interfaces

Item	Designation	Terminal	Pin	Explanation
1	Terminal for self-consumption	X461	1 - 2	Contact (NO switch) for self-consumption control
2	Terminal for digital connection for ripple control receiver or control box	X401	1	VDD (+12 to 14 V supply voltage)
			2	Input 1
			3	Input 2
			4	Input 3
			5	Input 4
			6	GND (0 V ground)
3	Terminal for communication with battery via RS485 or CAN	X601	1	VDD (+12 to 14 V supply voltage)
			2	CANopen High interface (data +)
			3	CANopen Low interface (data -)
			4	RS485 interface B (data -)
			5	RS485 interface A (data +)
			6	GND (0 V ground)
			7	not used
4	Not used (terminal X602)	X602	1 - 4	-
5	Terminal for energy meter (Modbus RTU)	X452	1	Interface A (data +) RS485/Modbus RTU
			2	Interface B (data -) RS485/Modbus RTU
			3	GND
6	USB 2.0 interface	X171	1	USB 2.0 max. 500 mA (currently only for service)
7	Ethernet connection (RJ45)	X206	1	RJ45 max. 100 Mbit (LAN connection for linking e.g. to a router)

3.6 Connecting energy meter

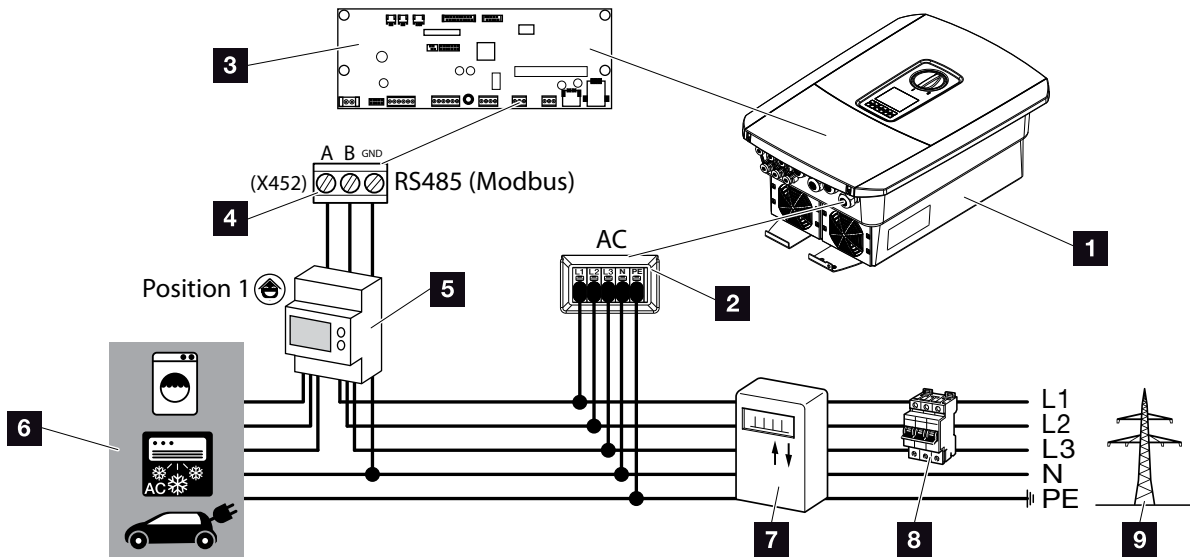

Fig. 27: Wiring diagram for energy meter - house connection (position 1)

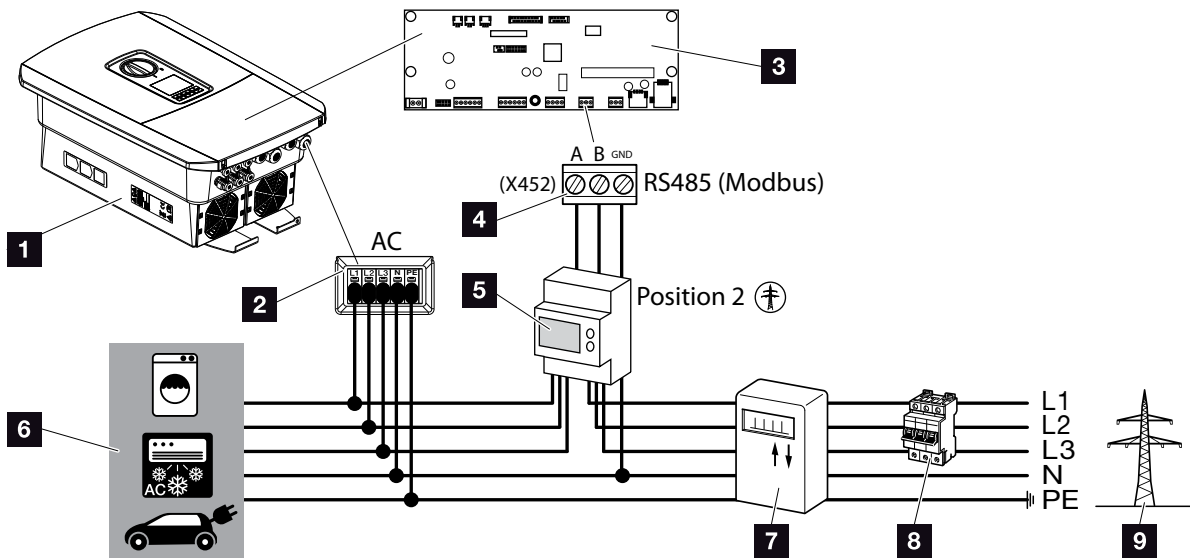



Fig. 28: Wiring diagram for energy meter - grid connection (position 2)

- 1 Inverter
- 2 Inverter - AC terminal
- 3 Smart Communication Board
- 4 Terminal for energy meter
- 5 Digital energy meter (Modbus RTU)
- 6 Consumer device
- 7 Purchase and feed meter or smart meter
- 8 Line fuse for house
- 9 Public grid

The energy meter is installed on a top-hat rail in the meter box or the main distributor.

The energy meter can be fitted in 2 positions in the house grid (position 1 = home consumption, position 2 = grid connection point). Both installation positions are possible. Preference should be given to position 1 as it offers better measurement accuracy. The installation position is queried and set in the installation wizard or can be set in the Webserver.

The diagram only provides one example because the connections may differ depending on the energy meter used. 



IMPORTANT INFORMATION

Only energy meters which have been approved for the inverter by KOSTAL Solar Electric may be used.

You will find an up-to-date list of the approved energy meters on our homepage in the download area for the product.

The following energy meters are currently approved:

- KOSTAL Smart Energy Meter
- TQ EM 300 LR
These meters can be used by the energy supply company to monitor, to control the battery and to control feed-in (e.g. 70%).
- B+G SDM630-Modbus
This meter can only be used to monitor home consumption.

1. De-energise the house grid. ⚠
2. Fit the energy meter on the top-hat rail in the control cabinet or power distributor.
3. Correctly route the communication cable from the inverter to the control cabinet and connect to energy meter following wiring diagram provided by manufacturer. ⓘ
4. Connect communication cable in inverter to terminal for energy meter (torque: 0.2 Nm).

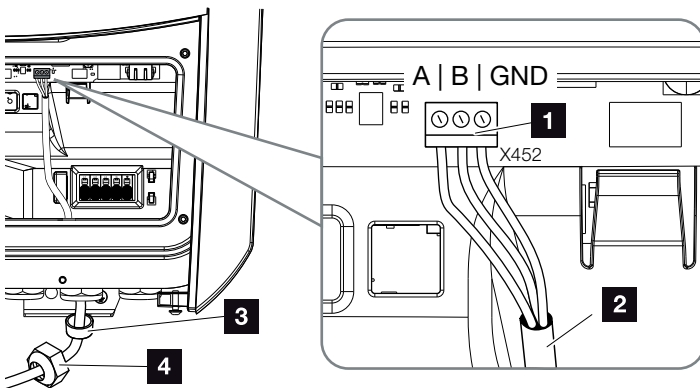

Fig. 29: Connection for digital energy meter (Modbus RTU)

- 1 Terminal for energy meter (Modbus RTU)
- 2 Communication cable to energy meter
- 3 Sealing ring
- 4 Union nut

✓ The energy meter is connected.

The type of energy meter used is selected when the inverter is first installed or can be set using the inverter menu or Webserver.



DANGER

RISK OF DEATH DUE TO ELECTRICAL SHOCK AND DISCHARGE!

De-energise all devices and secure them against being switched on again.



INFO

The communication cable is subject to the following requirements:

- Wire cross-section of
0.34 - 1.5 mm² (rigid)
0.34 - 1.0 mm² (flexible)
- Max. length 30 m.
- Length of stripped insulation 4.5-5.5 mm.

3.7 Connecting the ripple control receiver

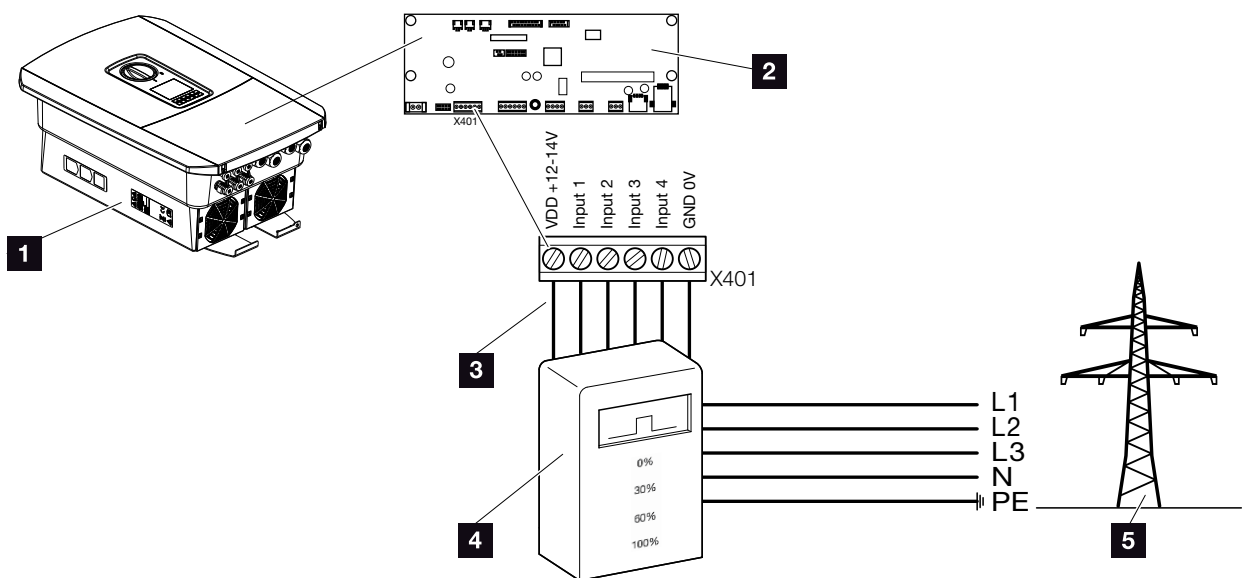

Fig. 30: Ripple control receiver

- 1 Inverter
- 2 Smart Communication Board (SCB)
- 3 Control line for ripple control receiver
- 4 Ripple control receiver
- 5 Energy supply company

Several energy supply companies offer the owners of PV systems the possibility of regulating their system with variable active power control and thus increasing the feed-in into the public grid to up to 100%. **i**

Ask your energy supply company or installer what application rule applies to you or whether there is an alternative (e.g. smart meter) better suited to you.

If a ripple control receiver is already connected to another KOSTAL solar inverter in your house grid, you can use the control signals of this ripple control receiver. In order to do this, receipt of broadcast control signals must be activated in the Webserver by going to Service menu > Energy management. **☑ “Webserver menu - Service menu - General” on page 136**



INFO

In some applications, the digital energy meter may be seen as an attractively priced alternative to the ripple control receiver. The feed-in may be limited by the energy supply company but the inverter controls the flow of energy (self-consumption in house grid and feed-in to the public grid) in such a way that the least amount of self-generated energy is lost or none at all.

Dynamic active power control can be activated in the inverter to this end.

☑ Ch. 9

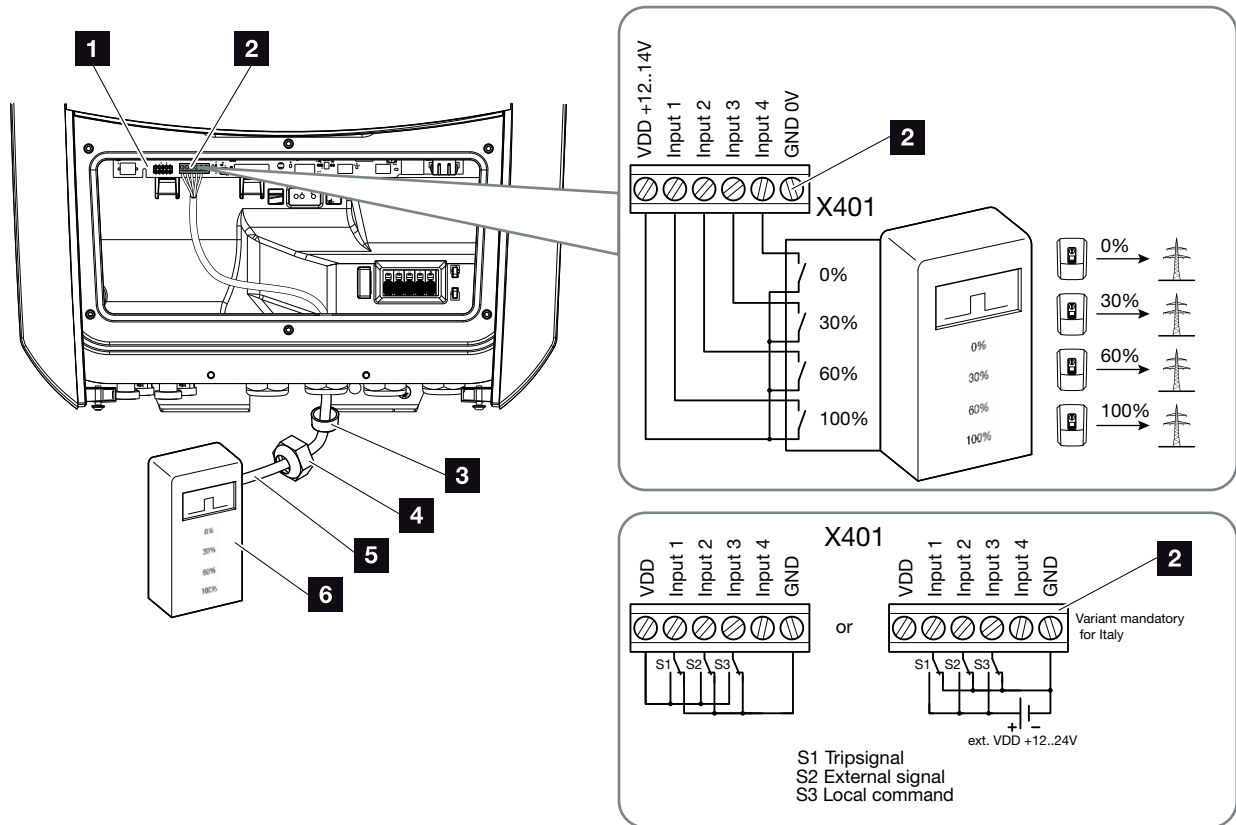

Fig. 31: Connection of ripple control receiver 





- 1** Smart Communication Board
- 2** Terminal for ripple control receiver
- 3** Sealing ring
- 4** Union nut
- 5** Control line
- 6** Ripple control receiver



IMPORTANT INFORMATION

For Italy (standard CEIO-21), no voltage may be applied to terminal X401.1 (VDD).

Connection to an external voltage source and a changeover switch to GND is mandatory here.

1. De-energise the house grid.  **Ch. 4.3** 
 2. Fit ripple control receiver in control cabinet or power distributor.
 3. Correctly route the communication cable from the inverter to the control cabinet and connect to ripple control receiver following wiring diagram provided by manufacturer. 
 4. Connect communication cable in inverter to terminal for ripple control receiver (torque: 0.2 Nm)
 **Fig. 31, item 2**
 5. Once the inverter has undergone initial commissioning, the ripple control receiver still needs configuring in the Webserver. Forwarding of the ripple control receiver's signals (distribution of broadcast control signals) to other inverters in the same house grid can also be activated.
- ✓ The ripple control receiver is connected.

More information about the configuration  **Ch. 9**



DANGER

RISK OF DEATH DUE TO ELECTRICAL SHOCK AND DISCHARGE!

De-energise device and secure against being switched on again.

 **Ch. 4.3**



INFO

The communication cable is subject to the following requirements:

- Wire cross-section of
0.34 - 1.5 mm² (rigid)
0.34 - 1.0 mm² (flexible)
- Max. length 30 m
- Length of stripped insulation 4.5-5.5 mm

3.8 Connection for self-consumption control

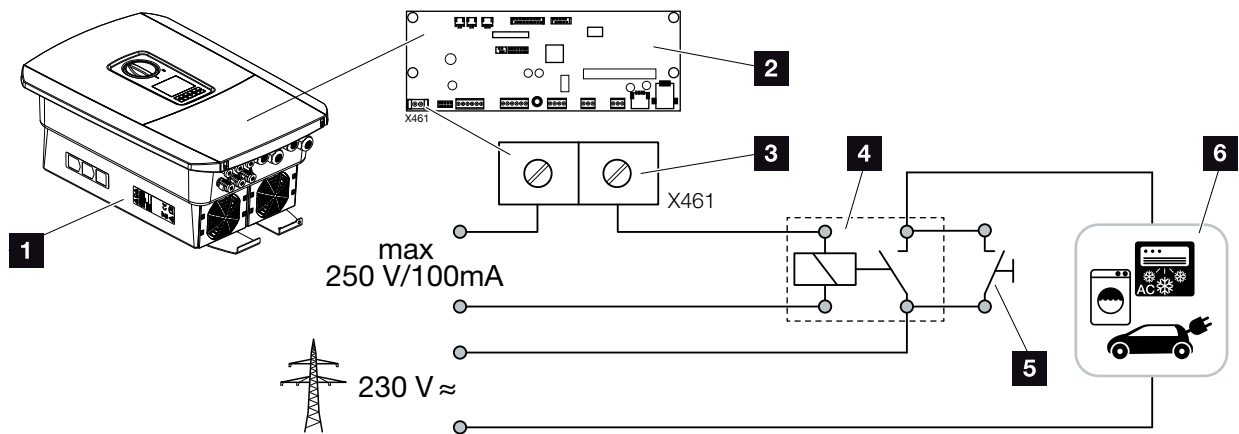

Fig. 32: Connection for self-consumption control

- 1 Inverter
- 2 Smart Communication Board
- 3 Terminal for self-consumption control
- 4 Load relay
- 5 Jumper switch
- 6 Consumer device

The inverter allows consumers to be connected to it via an external load relay. The consumers can then be switched on when there is sufficient PV power and thereby access the PV energy generated at that point in time. **i**

More information about the connection and configuration

Ch. 10

- ✓ Self-consumers connected.



INFO

The control line is subject to the following requirements:

- Wire cross-section of
0.14 - 2.5 mm² (rigid)
0.14 - 1.5 mm² (flexible)
- Max. length 30 m
- Length of stripped insulation 5.5-6.5 mm

3.9 Communication connection

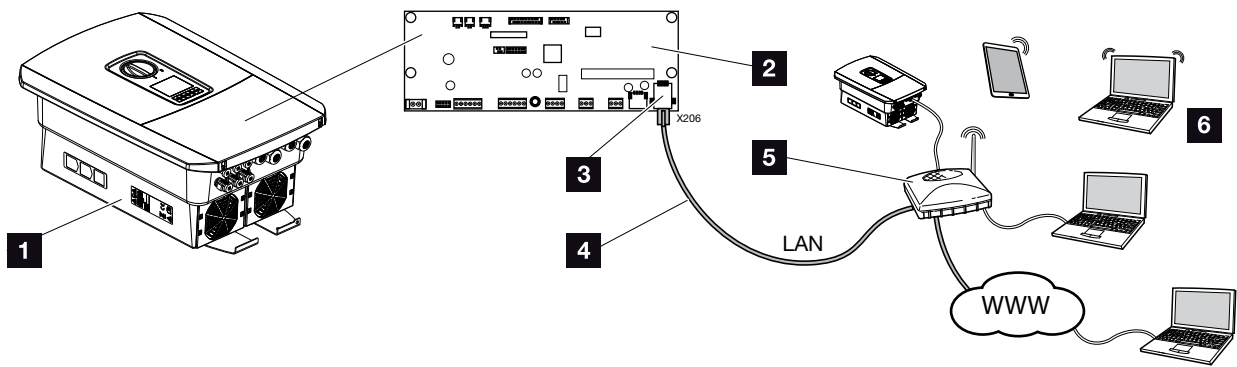

Fig. 33: Communication connection

- 1 Inverter
- 2 Smart Communication Board
- 3 RJ45 connection socket (Ethernet/LAN)
- 4 LAN cable
- 5 Router
- 6 Computer / router / tablet / KOSTAL solar inverter (for configuration or data retrieval)

The Smart Communication Board is the inverter's communication hub. To this end, computers, routers, switches and/or hubs can be connected to the RJ45 connection.

If the Ethernet cable is connected to a router, the inverter is integrated into your own network and can be contacted by all computers or KOSTAL solar inverters incorporated into the same network.

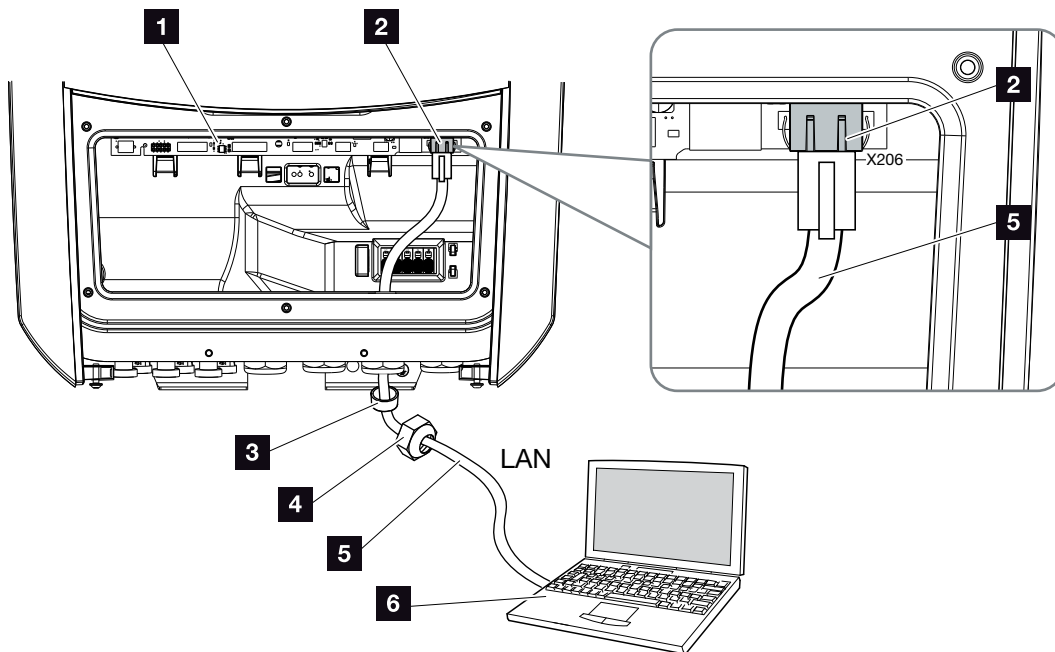

Fig. 34: Connecting inverter and computer with an Ethernet cable

- 1 Smart Communication Board
- 2 LAN connection (RJ45 Ethernet)
- 3 Sealing ring
- 4 Union nut
- 5 Ethernet cable (Cat 6)
- 6 Computer (for configuration or data retrieval)

1. De-energise the inverter's terminal compartment.
⚡ **Ch. 4.3** ⚡
 2. Insert Ethernet cable into the inverter and seal with sealing ring and union nut. Tighten union nut to the prescribed torque. Torque: 8 Nm (M25). i
 3. Connect Ethernet cable to LAN interface of Smart Communication Board.
📐 **Fig. 34 It. 2**
 4. Connect the Ethernet cable to the computer or router.
- ✓ The inverter is connected to the internal network.



DANGER

RISK OF DEATH DUE TO ELECTRICAL SHOCK AND DISCHARGE!

De-energise device and secure against being switched on again.

📐 Ch. 4.3



INFO

For connection with a computer or computer network (Ethernet 10BaseT, 10/100 MBit/s), an Ethernet cable of category 6 (Cat 6, FTP) with a max. length of 100 m is to be used.

3.10 Connecting battery

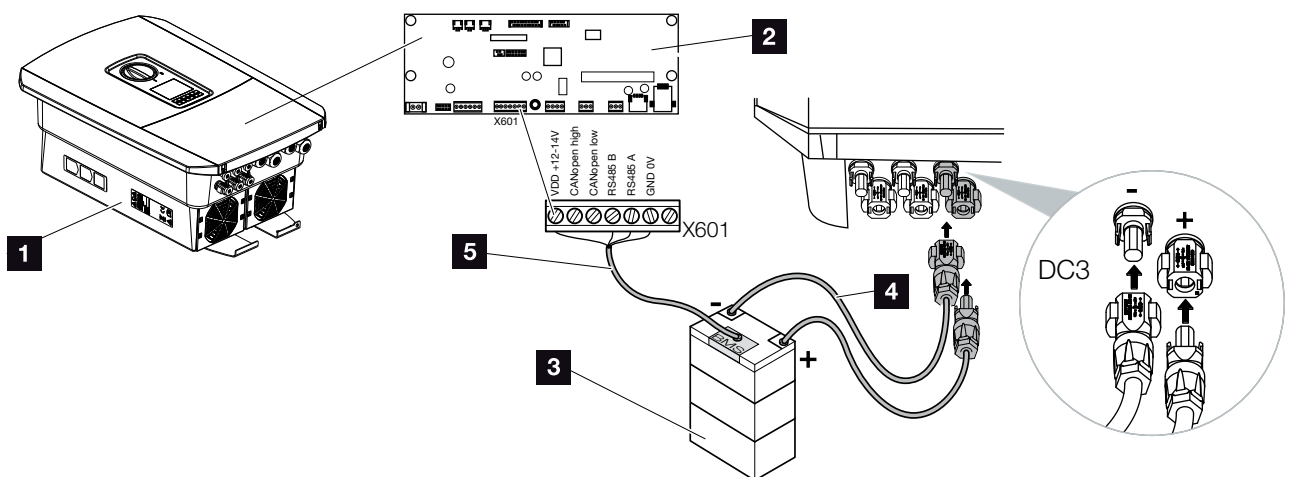



Fig. 35: Battery storage connection

- 1 PLENTICORE plus inverter
- 2 Smart Communication Board
- 3 Battery storage with battery management system
- 4 DC cables for battery storage
- 5 Communication cable to battery storage

On the PLENTICORE plus inverter, you can connect a battery storage system to the DC input 3 in place of a PV string.

However, this can only be done if DC input 3 has been released for this option. The battery storage connection is activated by entering a battery activation code. You can purchase the battery activation code from the KOSTAL Solar online shop.

Please note the following:

- Battery use must be released in the inverter.
- Only battery storage systems (manufacturers) which have been approved by KOSTAL Solar Electric GmbH may be connected to the inverter. 



INFO

A list of approved battery storage systems is available in the download area for the product on our homepage at www.kostal-solar-electric.com

Activation of battery input

If DC input 3 on the inverter has not been activated for battery use, the battery activation code must be entered in the inverter for this purpose. There are three ways of doing this 

Input of code upon initial commissioning:

During initial commissioning, the commissioning wizard asks for the battery activation code under the Extra options. When this happens, enter the 10-digit battery activation code using the control buttons on the inverter and confirm your input.

Once acknowledged by the inverter, DC input 3 can be used to connect battery storage and a battery type can be selected.

✓ Activation is complete.

Input of code via Webserver:

After initial commissioning, the battery activation code can be entered via the Webserver.

Calling up Webserver

Go to “Service menu > Extra options > Release new option”.

Enter the 10-digit battery activation code and confirm. The battery type should then be selected.

✓ Activation is complete.



INFO

Be sure to use a valid activation code. If the details entered are incorrect, the inverter will be blocked after the 5th attempt at entry and can only be enabled again by disconnecting it totally from the AC and DC voltage supply.

Input of code via inverter menu:

After initial commissioning, the battery activation code can be entered in the inverter via the following menu item:

Settings > Extra options > Activate options

Enter the 10-digit battery activation code and confirm.
The battery type should then be selected.

✓ Activation is complete.

Battery communication connection

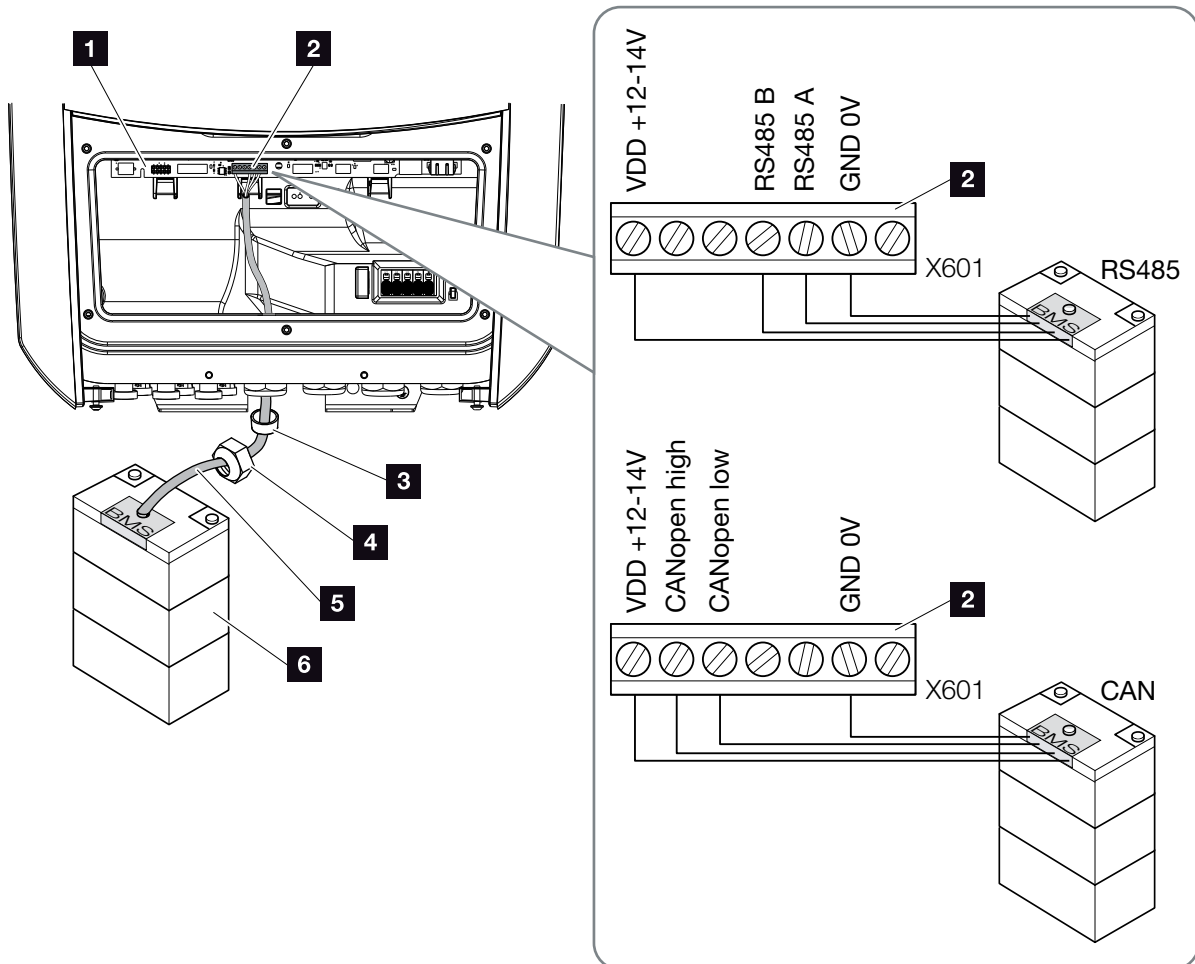

Fig. 36: Battery communication connection via RS485 or CAN



1. The communication cable may only be connected to the inverter if the terminal compartment of the inverter and battery storage are voltage-free. De-energise inverter and battery storage. ⚠



DANGER

RISK OF DEATH DUE TO ELECTRICAL SHOCK AND DISCHARGE!

De-energise inverter and battery storage. Please also observe the instructions in the operating manual provided by the battery manufacturer.

2. Insert communication cable of battery storage into the inverter and seal with sealing ring and union nut. Tighten union nut to the prescribed torque. Torque: 8 Nm (M25). 
 3. Connect communication cable (RS485 or CAN) to communication interface of Smart Communication Board.  **Fig. 36 It. 2**
 4. In the battery storage system, connect the communication cable to the battery management system. To do this, consult the operating manual provided by the battery manufacturer.
- ✓ The communication cable has been connected.



INFO

The communication cable is subject to at least the following requirements. Please consult the manual provided by the battery manufacturer for more details.

- Wire cross-section
0.34 - 1.5 mm² (rigid)
0.34 - 1.0 mm² (flexible)
- Outer diameter 5-10 mm
- Max. length 30 m
- Length of stripped insulation 4.5-5.5 mm
- Twisted pair (e.g. Cat.5e or better)

3.11 Closing the inverter

1. Tighten all cable glands and check that they are properly sealed.
2. Check the fit of connected wires and strands in the inverter.
3. Remove any foreign objects (tools, wire cuttings, etc.) from the inverter.
4. Install the terminal compartment cover and screw it tight (2.0 Nm).
5. Fit cover on inverter and screw it tight (1.5 Nm).

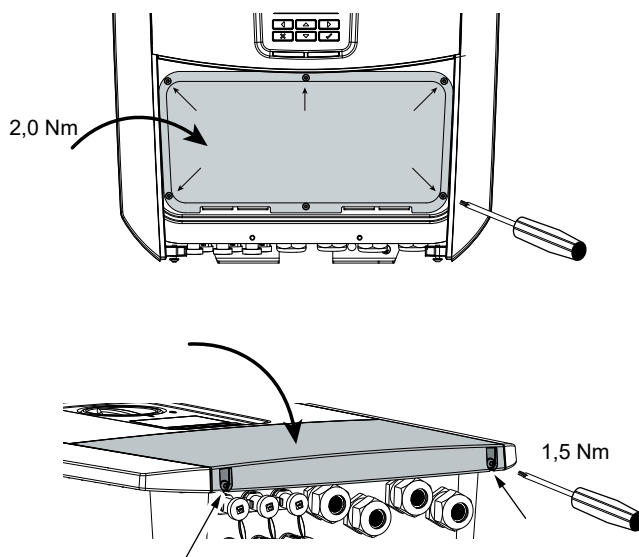

Fig. 37: Closing the inverter

3.12 Connecting battery's DC cables

The battery's DC cables may only be connected to the inverter if the inverter and battery storage are voltage-free.

1. De-energise the battery storage and inverter. ⚠
2. Correctly fit the plug on the positive cable and the socket on the negative cable. The inverter is equipped with plug connectors from PHOENIX CONTACT (type SUNCLIX). During installation, always observe the most recent specifications from the manufacturer (e.g. permissible tightening torque etc.).¹
3. When mounting the sockets and plugs on the DC cables used by the battery, ensure their polarity is correct! ⚠
4. Plug the sockets and plugs of the battery's DC cables onto the inverter. Keep the plug seals out of the plug connectors.

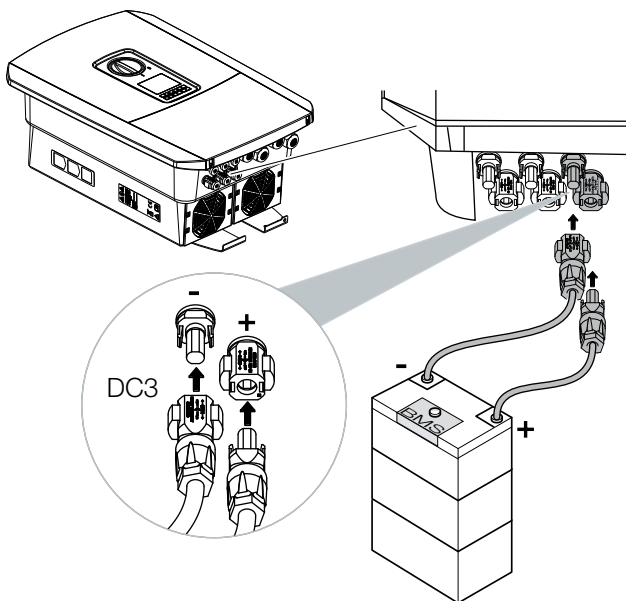

Fig. 38: Overview of battery DC connection



DANGER

RISK OF DEATH DUE TO ELECTRICAL SHOCK AND DISCHARGE!

The battery's DC cables may be energised. Be sure to de-energise the battery storage system. Please also observe the instructions in the operating manual provided by the battery manufacturer.

¹ Information about the SUNCLIX installation specification is available from:
www.phoenixcontact.com



IMPORTANT INFORMATION

Use flexible and tin-plated cables with double insulation according to EN50618.

We recommend a cross-section of 6mm². Please observe the specifications of the plug manufacturer and the technical data for the inverter.

5. Configuration and selection of battery type must take place after initial installation in the Webserver.
- ✓ The battery's DC cables are connected.

3.13 Connection of solar module

Solar module connections

Note the following before connecting the DC plugs:

- In order to ensure an optimal layout of the solar modules and the highest possible yields, the system should be designed within the voltage range between U_{MPPmin} and U_{MPPmax} . KOSTAL Solar Plan should be used as a planning tool here.
- Check for the correct planning and wiring of the modules and then measure the DC idling voltage.
- Please ensure that the maximum permitted DC idling voltage is not exceeded. Log these measuring values and make them available in the event of complaints.
- If the output of the solar modules is higher than that specified in the technical data, it must be ensured that the working point is still within the MPP voltage range of the inverter.
- The solar module types used in one PV string should all be the same. This avoids loss of earnings.

Failure to do so will make any manufacturer's warranty, guarantee or liability null and void unless you can prove that the damage was not due to non-compliance.



WARNING

RISK OF FIRE DUE TO IMPROPER INSTALLATION!

Incorrectly fitted plugs and sockets may heat up and cause a fire. During installation, be sure to follow the manufacturer's requirements and manual. Properly mount plugs and sockets.



WARNING

SERIOUS BURNS DUE TO ARCS ON THE DC SIDE!

DC cables must never be connected to or disconnected from the device during operation, as dangerous arcs may form. De-energise DC side, then mount or remove plug connector!



WARNING

INJURIES CAN RESULT FROM DESTRUCTION OF THE DEVICE!

When the maximum values for the permitted input voltage at the DC inputs are exceeded, this can result in serious damage, which may destroy the device and cause serious injury to any person present. Even briefly exceeding the voltage can cause damage to the device.

Connecting solar module ⚠

Only solar modules of the following category may be connected: Class A as specified in IEC 61730.

The PV generators may only be connected to the inverter when this is voltage-free.

1. De-energise the inverter. ⚠
2. If there is more than one inverter in a PV system, ensure that no cross-connection occurs when the PV generators are connected. ⚠

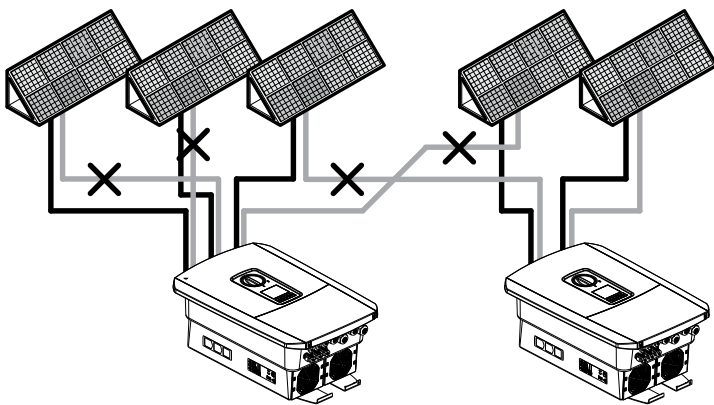

Fig. 39: Incorrect connection of PV generators

3. Check the strings for earth faults and short circuits and correct these where appropriate.
4. Correctly fit the plug on the positive cable and the socket on the negative cable. The inverter is equipped with plug connectors from PHOENIX CONTACT (type SUNCLIX). During installation, always observe the most recent specifications from the manufacturer (e.g. use of permissible tightening torques etc.).¹



DANGER

RISK OF DEATH DUE TO ELECTRICAL SHOCK AND DISCHARGE!

The PV generators/cables may be live as soon as they are exposed to light.



DANGER

RISK OF DEATH DUE TO ELECTRICAL SHOCK AND DISCHARGE!

De-energise device and secure against being switched on again.

➔ Ch. 4.3



DAMAGE POSSIBLE

If the PV generators are incorrectly connected (including cross-connection on the inverter itself), the inverter may be damaged. Check the connections before commissioning.

¹ Information about the SUNCLIX installation specification is available from:

www.phoenixcontact.com

5. When mounting the sockets and plugs on the DC cables used by the solar modules, ensure their polarity is correct! The poles of the PV strings (PV field) must not be earthed. !
6. Plug the sockets and plugs of the DC cables onto the inverter. Keep the plug seals from the plug connectors. !

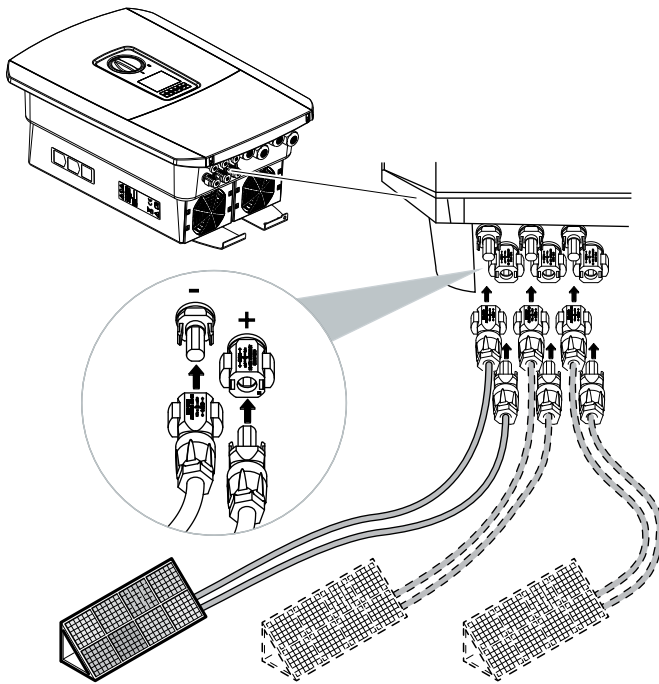

Fig. 40: Overview of DC connections

- ✓ The DC side is connected.



IMPORTANT INFORMATION

Use flexible and tin-plated cables with double insulation according to EN50618.

We recommend a cross-section of 6mm². Please observe the specifications of the plug manufacturer and the technical data for the inverter.





IMPORTANT INFORMATION

The solar module types used and the orientation in one PV string should be the same.

3.14 Initial commissioning

Procedure for initial commissioning

1. Activate the supply voltage via the line circuit breaker.
2. Switch the DC switch of the inverter to ON.  **Fig. 11**
If external DC voltage separators are present, activate the DC strings consecutively.
 - The installation wizard is shown on the display. 
3. Press the right arrow key to start the installation.
 - The “Language” menu is displayed.
4. Select language and confirm.
To do so, use the arrow keys to select a language. Confirm using “ENTER”.
5. Press the right arrow key to go to the next installation item.
 - The “Date and time” menu is displayed.
6. Select time zone and set date/time or run automatic detection. Confirm using “ENTER”. 
7. Press the right arrow key to go to the next installation item.
 - The “Energy management” menu is displayed.
8. Use the arrow keys to select the corresponding menu item and press the “ENTER” key.



IMPORTANT INFORMATION

At least the “Min. input voltage (U_{DCmin})” must be present for initial commissioning. The output must also be able to cover the inverter's self-consumption during initial commissioning.



INFO

The installation process can vary depending upon the software version of the inverter.



Information about using the menu:

 **Ch. 4.4**



INFO

The entry of date/time ensures that the downloaded log data has the correct time assigned to it.

9. For “Max. feed-in capacity” enter the value specified to you by the energy supply company. Do this by pressing “ENTER” and using the arrow keys to enter the value. Confirm each digit with “ENTER”. At the end, confirm the input with $\sqrt{}$.
10. Use the arrow keys to select the “Energy meter” field and press “ENTER”. Select the energy meter fitted from the list and confirm with “ENTER”. 
11. Use the arrow keys to select the “Sensor position” field and press “ENTER”. Select the position of the energy meter fitted in the building services and confirm with “ENTER”. 
12. Press the right arrow key to go to the next installation item.
→ The “Network IPv4” menu is displayed.
13. Press “ENTER” to activate the network protocol.
14. Enter the data relating to the network. This may be a fixed IP address for the inverter or obtaining the IP address automatically via DHCP.
Confirm the entries with “ENTER”.
15. Press the right arrow key to go to the next installation item.
→ The “Modbus SunSpec (TCP)” menu is displayed.
16. If you need the Modbus SunSpec protocol via TCP, e.g. for externally connected monitoring of the inverter, you can activate it here. To do this, press “ENTER” to activate the Modbus SunSpec protocol.



INFO

A list of approved energy meters and their purpose are available in the download area for the product on our homepage at

www.kostal-solar-electric.com



INFO

Position 1 (home consumption) or 2 (grid connection) states the installation position for the energy meter in the house grid.





17. Press the right arrow key to go to the next installation item.
 - The “Solar portal” menu appears on the display.
18. Select the corresponding menu item with the arrow keys.
19. Press “ENTER” and select the solar portal used. Confirm the entries with “ENTER”.
20. To activate the transfer, highlight the item and confirm with the “ENTER” key.
 - The transfer is activated
21. Press the right arrow key to go to the next installation item.
 - The “Extra option” menu appears on the display.

This item can be used to release options by entering an activation code in the inverter. The activation code e.g. for connecting a battery to the DC input 3 on the inverter can be purchased from our online shop.  Select the “Release option” and confirm the input with the “ENTER” key. Enter the code you obtained previously in the KOSTAL Solar online shop. At the end, confirm the input with \checkmark .



INFO

The extra options currently released are shown under “Released options”.

22. Press the right arrow key to go to the next installation item.
 - The “Battery type” menu is displayed.
23. If there is a battery connected to the inverter, the connected battery type can be selected here. Use the arrow keys to select the battery type. Confirm the entries with “ENTER”. 
24. Press the right arrow key to go to the next installation item.
 - The “Country/guideline” menu appears on the display.
25. Select country or guideline used. Confirm the entries with “ENTER”.
26. Press the right arrow key to go to the next installation item.
 - “Accept settings” appears on the display.
27. Press “ENTER” to accept the input. 
 - The settings are applied by the inverter.
 - The inverter restarts after the installation.
 - ✓ The inverter is in operation and can now be used. Initial commissioning is completed.  



INFO

A list of approved battery storage systems is available in the download area for the product on our homepage at www.kostal-solar-electric.com



INFO

If an incorrect country setting has been selected, it can be reassigned using the inverter’s menu item “Reset country policy”.



INFO

If there is an update available for the inverter, install this first.





INFO

In France, the installer is personally responsible for obtaining any additional prescribed labels as required and attaching them to the inverter and feed cables.

3.15 Configuring settings in the Webserver

After the initial installation, more settings can be made using the inverter's menu or more conveniently via the Webserver.

To do this, use your PC or tablet to log into the Webserver as an installer.  **Ch. 6.1.** 

The following settings should be made after the initial commissioning:

- Inverter settings made by installer
- Prescribed settings for grid feed-in from energy supply company.
- Registration on the KOSTAL Solar Portal if this has not yet been done.
- With a battery connected, select the battery type and undertake battery configuration.
- Make further settings, such as changing the password or updating the inverter software.



INFO

Parameters governed by the grid, limitations and guidelines can only be modified with a service code

To log in as an installer, you need the master key from the inverter's type plate and your service code, which can be requested from our service team.  **Ch. 14.2**

4. Operation and operating the device

4.1	Switching on the inverter	80
4.2	Switching off the inverter	81
4.3	De-energising the inverter	82
4.4	Control panel	84
4.5	Operational status (display)	87
4.6	Operational status (LEDs)	90
4.7	The menu structure of the inverter	91

4.1 Switching on the inverter

1. Activate supply voltage via the line circuit breaker.
2. If present, switch on battery storage using battery switch.

→ The battery storage starts up.

3. Move DC switch on inverter to ON position.

 **Fig. 11**

If external DC voltage separators are present, activate the DC strings consecutively.

→ The inverter starts up.

→ During start-up, the LEDs in the control panel of the inverter light up briefly.

→ The screensaver appears on the display and displays the device type. The screensaver is deactivated when a key is pressed twice. 

✓ The inverter is in operation.





INFO

When no key has been pressed for several minutes, the screensaver with the image of the inverter appears automatically on the display.

4.2 Switching off the inverter

To interrupt the inverter's feed-in to the public grid, proceed as follows.

Additional steps are necessary for repair work on the inverter.  **Ch. 4.3.**

1. Turn the DC switch on the inverter to OFF.  **Fig. 12**
 2. If external DC voltage separators are present, switch off the DC strings consecutively.
 3. If a battery is connected, switch off the battery storage. 
- ✓ The inverter no longer feeds into the public grid. The inverter remains energised and monitoring is still performed.



INFO



You will find a detailed description of how to switch off the battery storage in the operating manual provided by the battery manufacturer.

4.3 De-energising the inverter

When working in the terminal compartment

When working in the inverter's terminal compartment, this area must be de-energised. ⚠

It is imperative that these steps are carried out:

1. Turn the DC switch on the inverter to OFF.  **Fig. 12**
 2. If used, switch off power supply for the self-consumption output.  **Ch. 10.1.**
 3. Switch off the AC line circuit breaker.
 4. Secure the entire voltage supply against being restarted.
- ✓ The inverter's terminal compartment is now voltage-free (high voltage). The Smart Communication Board (SCB) is still supplied with voltage by the PV string and can display values in the inverter's display. The levels of voltage on the SCB are very low and not dangerous at all. Work in the inverter's terminal compartment or on the AC line can now be carried out. ⚠



DANGER

RISK OF DEATH DUE TO ELECTRICAL SHOCK AND DISCHARGE!

De-energise device and secure against being switched on again.



DANGER

RISK OF DEATH DUE TO ELECTRICAL SHOCK AND DISCHARGE!

Further steps should be taken when working on the DC feed cables (PV or battery). These steps can be found on the following page.

When working on the DC feed cables

When working on the DC feed cables, the inverter must be **completely** de-energised. ⚠

It is absolutely essential that these steps are taken in addition to those stated previously:

1. If present, switch off the connected battery storage. **i**
2. Disconnect all DC connections on the inverter. To do this, unlock the engaging clips with a screwdriver and disconnect the plug. ¹

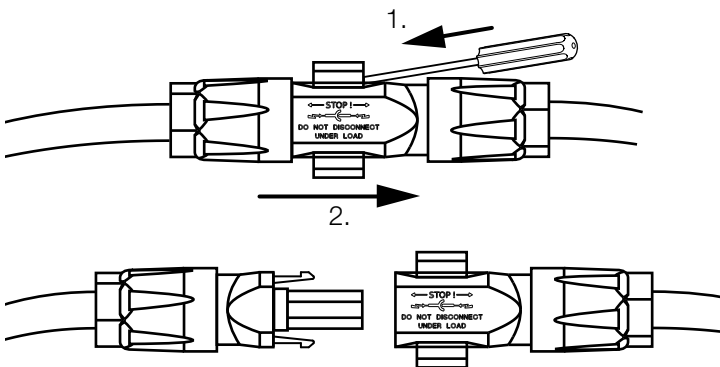

Fig. 41: Disconnecting SUNCLIX DC plug

3. Ensure that all connections are voltage-free.
- ✓ The inverter is now completely voltage-free. Work on the inverter or on the DC feed cables can now be carried out.



DANGER

RISK OF DEATH DUE TO ELECTRICAL SHOCK AND DISCHARGE!

De-energise all devices and secure them against being switched on again.



INFO

You will find a detailed description of how to switch off the battery storage in the operating manual provided by the battery manufacturer.

¹ Information about the SUNCLIX installation specification is available from:
www.phoenixcontact.com

4.4 Control panel

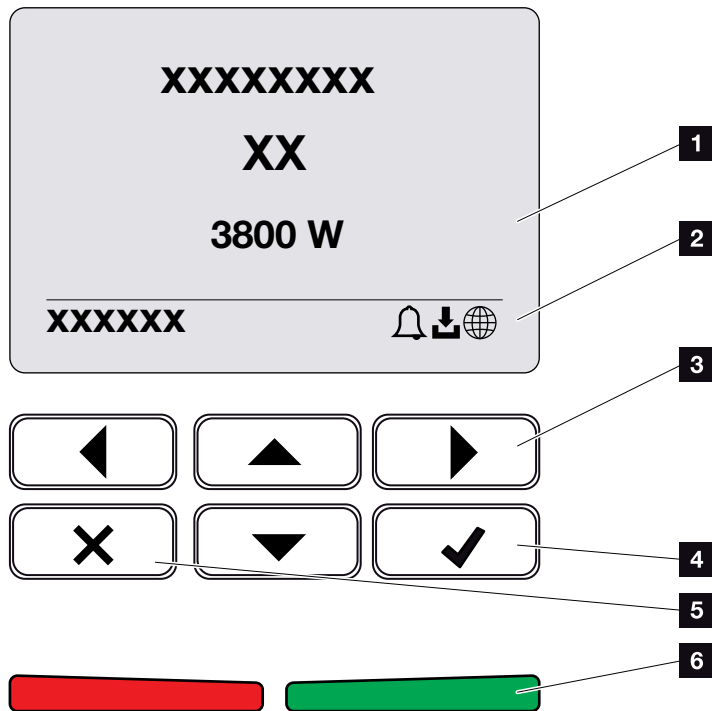

Fig. 42: Control panel

- 1 Display
- 2 Status display
- 3 Arrow key for navigating around the menus
- 4 “ENTER” key (for confirmation)
- 5 “DELETE” key (for clearing) or for exiting the menu
- 6 Status LED “Fault” (red), “Warning” (flashing red), “Feed-in” (green), “Feed in limited” (green flashing)

The inverter indicates the respective operational status through two LEDs and the display. **i**

The operating values can be retrieved and settings adjusted on the display.



INFO

When no key has been pressed for several minutes, the screensaver with the image of the inverter appears automatically on the display.

Operation of the display

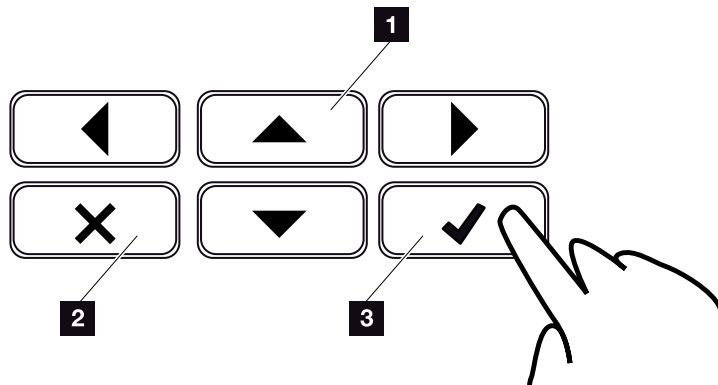

Fig. 43: Operation of the display

- 1 UP/DOWN / LEFT / RIGHT:** Characters, buttons, functions and input fields are selected with the arrow keys.
- 2 DELETE /Abort:** Pressing the “DELETE” key cancels the selection, input or value, aborts an input or jumps up a menu once the input has been confirmed.
- 3 ENTER / Confirm:** Pressing the “ENTER” key activates the selected menu element or confirms the input. Clicking in the “ENTER” input box saves the value.

Entry of text and numbers

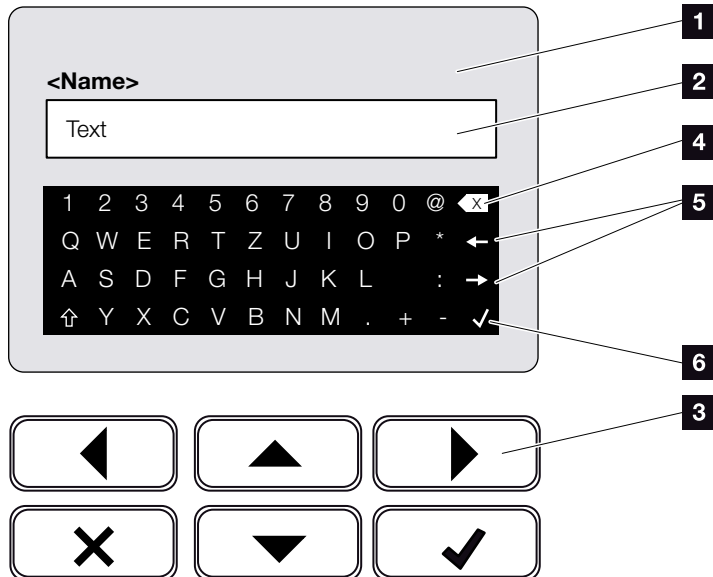

Fig. 44: Using keyboard to operate the display

- 1** Inverter display
- 2** Input box
- 3** Select character using the arrow keys, confirm with "ENTER" or exit the menu with "X".
- 4** Individual characters to the left of the cursor can be deleted with the backspace key (<-).
- 5** The arrow keys can be used to move the cursor within the text.
- 6** The "Accept data" key is used to save the entry and close the menu.

The display can be used to enter texts and numbers (e.g. inverter name). When input is required, a keypad of letters and numbers appears under the input box in order to do this.

4.5 Operational status (display)

The operational statuses of the inverter are shown on the display of the inverter: **i**

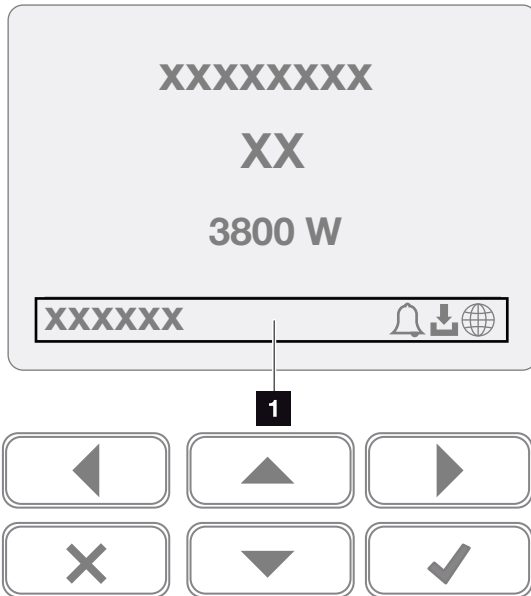

INFO



The user interface/menu entries in the inverter depend on the installed inverter firmware (FW) and the user interface software (UI) in the inverter and may deviate from the description provided here.

Fig. 45: "Operational status" display area

- 1** Display area, information and inverter status displayed

The following table explains the operational notifications that can appear on the display:

Display	Explanation
Off	Input voltage on the DC side (photo-voltaic modules) is too low or inverter switched off.
Bell symbol	An event is present. Remedial measures can be found in the "Event codes" chapter Ch. 11.5 The result can be queried in the inverter menu by going to Service > Event list or can be called up using the "Down" arrow key.
Download symbol	There is a software update available for the inverter. The update can be initiated in the inverter menu by going to Service > Updates or via the Webserver.
Globe symbol	Shows a successful connection to the solar portal.

Display	Explanation
IP address	The IP address of the inverter is displayed.
Insulation measurement	Device performs an internal check
Grid check	Device performs an internal check
Starting	Internal control measurements according to VDE 0126
Starting, including check of DC generators	Device performs an internal check
Feed in	Measurement successful, MPP control active (MPP = maximum power point)
Feed-in ext. regulated	Feed-in is regulated on the basis of a fault (e.g. PV energy is limited  Ch. 9 , excess temperature, fault)
Shutdown by ext. signal	The feed-in is limited as a result of the energy supply company's external signal.
Event xxxx, yyyy	An event is present. Up to two active events can be displayed. Remedial measures can be found in the "Event codes" chapter  Ch. 11.5
Waiting time ...	<p>The device is not feeding into the public grid as a result of an event.</p> <p>Grid synchronisation: The inverter synchronizes itself with the public grid and feeds in.</p> <p>Grid check: a grid check is performed.</p> <p>Grid error: there is an error in the public grid. As soon as this is rectified, the inverter feeds in again.</p> <p>Overheating: The inverter's temperature is too high. As soon as this has fallen, the inverter feeds in again.</p>
DC voltage too low	Electronics are ready for operation, DC voltage is still too low for feed-in.
Impermissible DC voltage	DC voltage still too high.

Display	Explanation
Equalisation charge (only if battery is connected)	The battery which is connected to the inverter is charged from the public grid using an equalisation charge. This is only done in winter mode and must be activated in the Service menu.
Battery sleep mode (only if battery is connected)	If insufficient energy for charging the battery is available for long periods, the battery is switched to sleep mode. This will protect the battery from total discharge. As soon as sufficient energy is available again, this mode is exited.

Tab. 4: Operating messages and symbols

4.6 Operational status (LEDs)

The LEDs on the front indicate the current operational status.

LEDs on the inverter

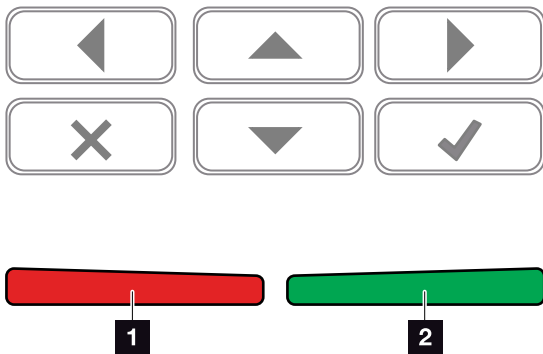

Fig. 46: LEDs on the display of the inverter

1 Red LED off:

There are no faults present

Red LED flashing:

There is an event (warning) active.

Red LED lit up:

A fault has occurred. Remedial measures can be found in the “Event codes” chapter [Ch. 11.5](#)

2 Green LED off:

Inverter not feeding in.

Green LED flashing:

Inverter feeding in with limitation.

Green LED lit up:

The green LED signals the feed-in mode of the inverter.

4.7 The menu structure of the inverter

The screensaver

After starting up or if no key has been pressed for a long time, the screensaver is displayed on the inverter.

Pressing any key activates the background lighting. The screensaver is exited by pressing another key (any key).

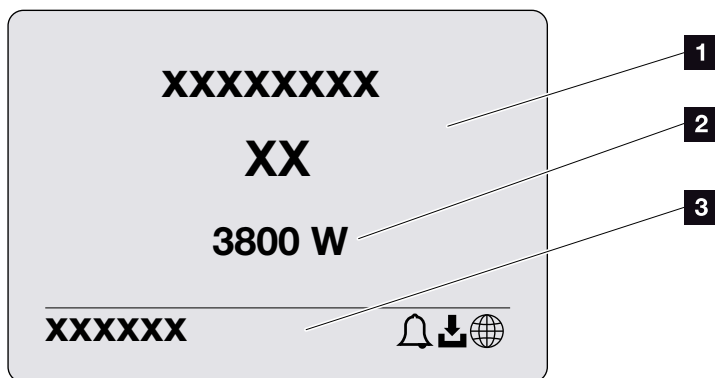

Fig. 47: Screensaver

- 1** Inverter type with power class
- 2** Current AC power, which is being fed into the public grid.
- 3** Status line, alternates every 5 seconds with:
 - IP address (if configured)
 - Inverter status
 - Event code (if available)
 - Solar portal connection active (if configured)

The power flow diagram

When the screensaver is being displayed, the power flow diagram can be displayed by pressing another key. The diagram is a very clear representation of the current power flow in the house grid and includes the relevant power values. The arrows indicate the direction in which power is flowing at present.

Pressing the “OK” key exits the power flow diagram and switches to the inverter menu level.

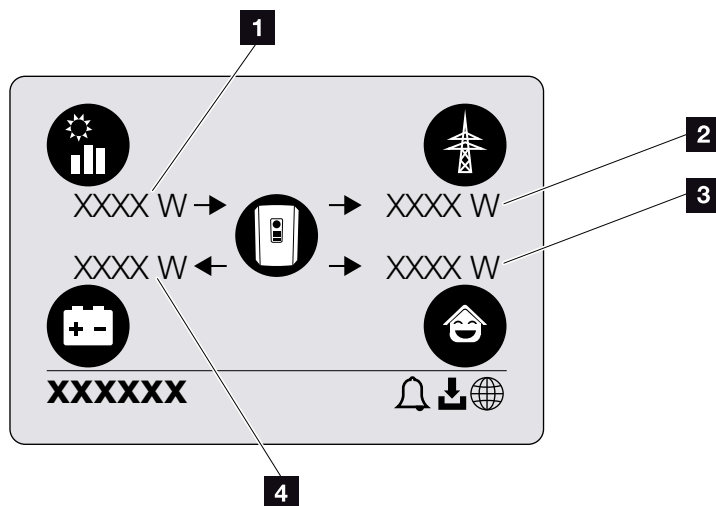

Fig. 48: Power flow diagram

- 1** Indication of power being generated by the PV modules.
- 2** Indication of power, which is being fed into or purchased from the public grid.
- 3** Display of the power that is consumed in the house.
- 4** Indication of power with which the battery is being charged or discharged.

The inverter menus

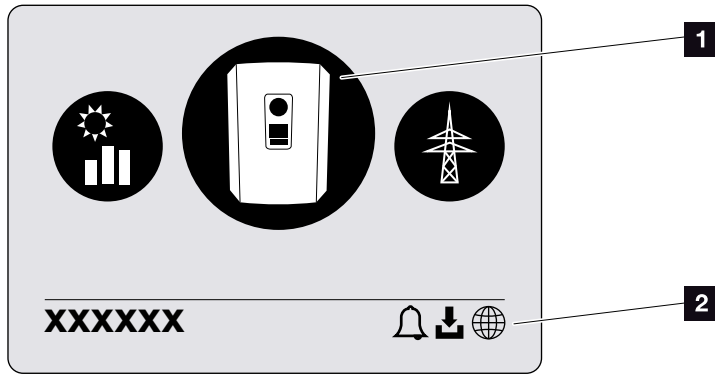



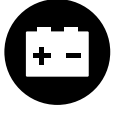



Fig. 49: Main menu structure

- 1** Active menu, selected using “ENTER”
- 2** Status line

The inverter provides the following menu items for querying statuses and configuring the inverter:

Symbol	Function
	Inverter settings
	Status query and information about the grid feed-in (AC side)
	Home consumption status query
	Battery charge and discharge power status query
	PV generators status query (DC side)

The menus are listed individually on the following pages.



INFO

The user interface/menu entries in the inverter depend on the installed inverter firmware (FW) and the user interface software (UI) in the inverter and may deviate from the description provided here.



Settings/information menu

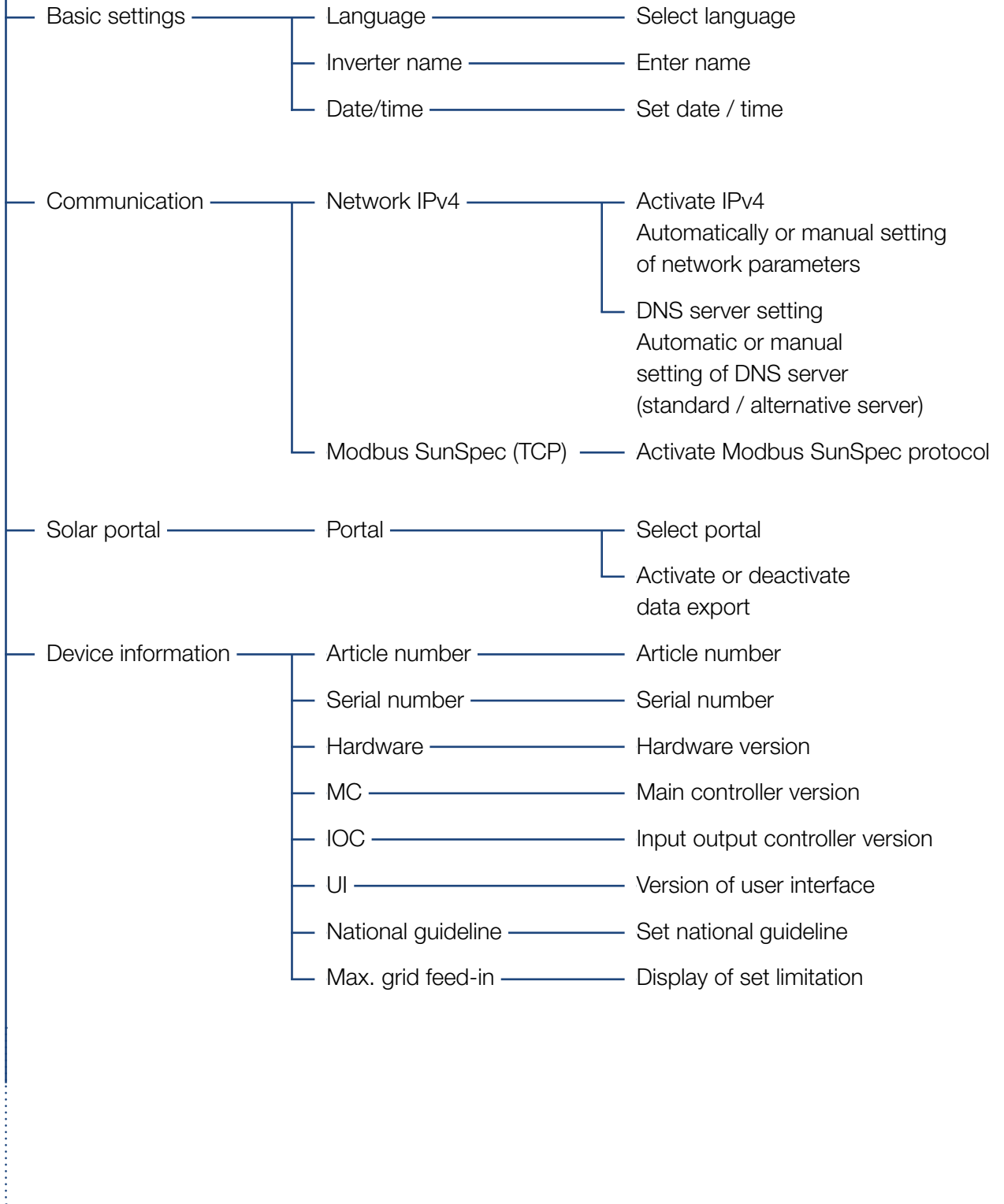

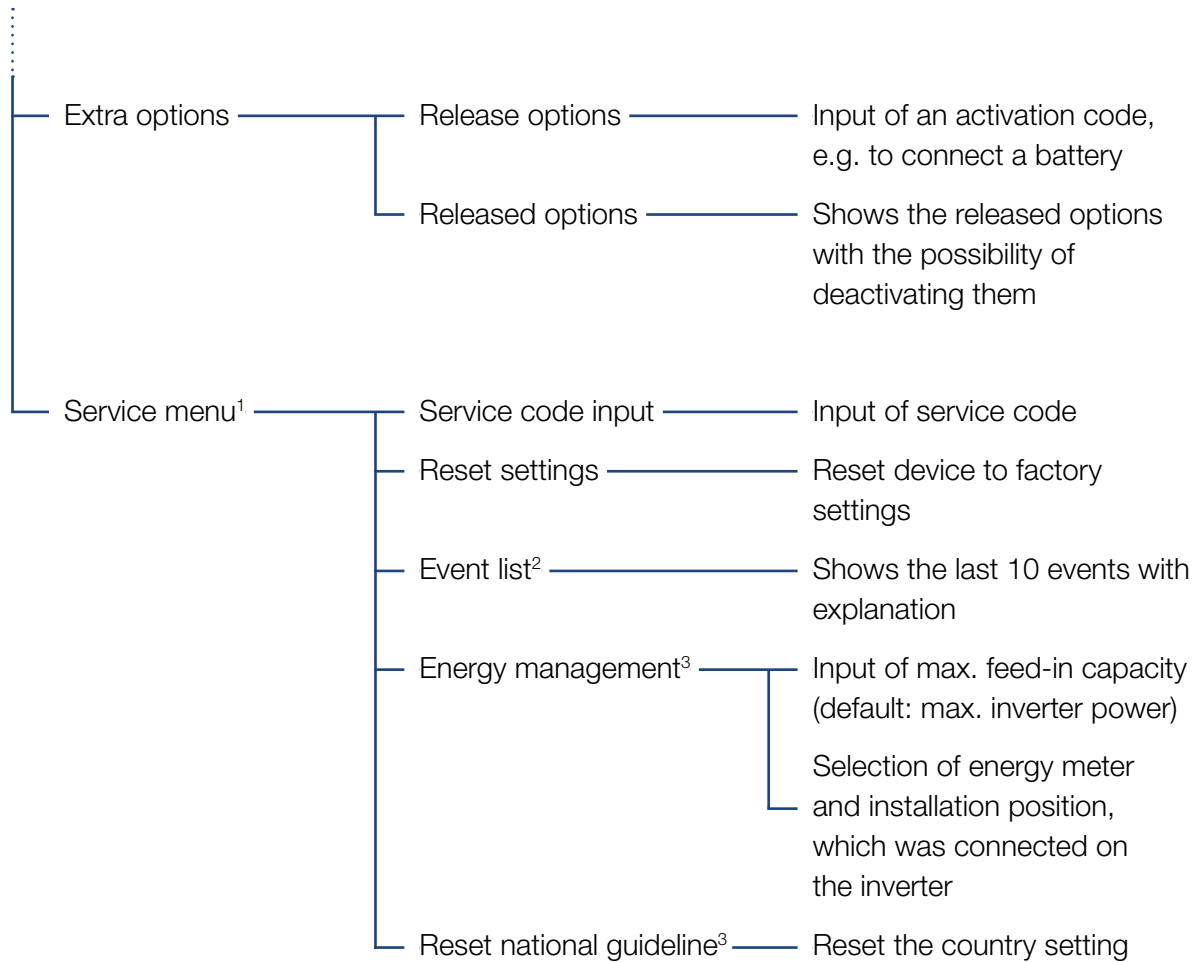

¹ Following entry of the service code, additional menu items for configuring the inverter appear. The code can be requested for installers from the Service team.

² A maximum of 10 events are displayed. Information about events can be found in the “Event codes” chapter.

³ Only possible if the service code is entered.



Menu AC side (grid)

- Current AC power — Shows the voltage (U), current (I) and power (P) per phase, which is being fed into the house grid.
- Yield overview — Shows the energy per day, month, year, total in Wh, kWh or MWh, which has been fed into the house grid.
- Grid parameter — Shows the current grid frequency, the set power factor (cos phi), the current power and, if configured, the set power curtailment, e.g. to 70%.



Home consumption menu

- Current consumption — Shows the current consumption in the house and the source from which it is being covered.
- Daily consumption — Shows the daily consumption in the house and the source from which it has been covered.
- Monthly consumption — Shows the monthly consumption in the house and the source from which it has been covered.
- Degree of self-sufficiency — Degree of self-sufficiency shows self-consumption in relation to home consumption. This states the percentage of energy consumed in the house that has been covered by the PV/battery energy generated.
- Self-consumption rate — Self-consumption rate shows the self-consumption in relation to the total power generated by the inverter. This states the percentage of generated energy used for self-consumption.



Battery menu

Battery status ————— Shows the current charging status, voltage, charge or discharge current and number of cycles of battery.



PV generator menu (DC side)

Current DC power ————— Shows the voltage (U), current (I) and power (P) per DC input¹

¹ This is displayed depending on the model or use of the 3rd DC input. If there is a battery connected to DC3, no values are displayed for this.

Settings/information menu

Configuration of the inverter and additional components (e.g. energy meter, battery etc.) is performed under Settings/information.

■ Basic setting

Set the general parameters of the inverter.

Parameter	Explanation
Language	Selection of menu language
Inverter name	Enter the inverter name. The characters a-z, A-Z, 0-9 and "-" are permitted for the name change. Spaces or special characters are not possible. The browser connection to the Webserver can be established with the new name following the name change. Access with the serial number remains possible.
Date/time	Enter the time and date. Set the time zone (e.g. UTC (+1:00) for CET) Activate/deactivate or automatic determination of time. The NTP server can be configured via the Webserver.

■ Communication

Set the communication parameters for the inverter's Ethernet connection. 

Parameter	Explanation
Network IPv4	<p>Activate the network protocol and configure the network interface (Ethernet) for the inverter.</p> <p>The "Automatic" option is activated by default.</p> <p>If configuring manually, the corresponding parameter values should be entered.</p> <p>Set the DNS server:</p> <p>The "Automatic" option is activated by default.</p> <p>If configuring manually, the corresponding parameter values should be entered.</p>
Modbus SunSpec (TCP)	Activate the protocol



INFO

The "Automatic" option is activated by default. This means that the inverter acquires its IP address from a DHCP server or automatically generates an IP address.

If the inverter is not allocated an automatic IP address through a DHCP server, the inverter can be configured using "Manually".

The data necessary for configuration, such as IP, router addresses etc., can be found on your router/gateway.

■ Solar portal

Input of solar portal configuration. If a solar portal is to be used, the log data and events are then sent to the solar portal.

Parameter	Explanation
Solar portal	Selection of solar portal.
Activate	Activated for starting to send to a solar portal.

■ Device information

Shows information about the versions installed on the inverter.

Parameter	Explanation
Article number	Article number of the inverter
Serial number	Inverter serial number
Hardware	Hardware version
MC	Main controller version
IOC	Input output controller version
UI	User interface version
National guideline	Shows the inverter's country setting
Max. output power	Shows the inverter's maximum output power.

■ Extra options

This function can be used to release additional options for the inverter. This may be e.g. releasing the DC3 input to connect battery storage.

Parameter	Explanation
Release option	Input of an activation code, e.g. to connect a battery. This first has to be purchased from the KOSTAL Solar online shop. 
Released options	Overview of options currently released in the inverter



INFO

The activation code can be purchased from the KOSTAL Solar online shop.

To visit the shop, go to shop.kostal-solar-electric.com

■ **Service menu** 

The installer or an experienced user can use the inverter's service menu to make settings on the inverter.

For the complete service menu to be displayed, the installer must request a code from the inverter manufacturer's service team.

The code is entered by going to the "Service code input" menu item.

Once the service code has been entered and confirmed, additional service menu entries appear.

Parameter	Explanation
Service code input	Input of service code and enabling of additional menu items.
Factory settings	Reset inverter to factory settings. This resets the following settings: Language, inverter name, date/time, network settings, protocol and solar portal.
Event list	Shows the last 10 events with date. Selecting an event and pressing the "OK" key displays a detailed view of the event.
Energy management (only available once service code has been entered)	<p>- Maximum grid feed-in Set the max. feed-in capacity. Requirements relating to this are generally specified by the energy supply company (e.g. a limitation to 70%). The inverter's max. power serves as the default.</p> <p>- Energy meter Selection of the energy meter fitted in the building services.</p>
Reset country setting (only available once service code has been entered)	Reset the country setting. After the reset, the commissioning wizard appears on the inverter following a restart 



INFO

The service menu entries depend on the installed inverter firmware (FW) and the user interface software (UI) and may deviate from the description provided here.

Some menu items can also be run without a service password. However, these items should only be run by experienced users because otherwise under certain circumstances the inverter may no longer function perfectly.



INFO

Should the inverter not restart automatically, switch it off using the DC switch and also the AC line circuit breaker. Wait 10 seconds and then restart in reverse order.

Menu - AC side (grid)

Shows the current energy values of the AC side.

■ Current AC power

Shows the current performance data of the grid side (AC) and how this is distributed to the phases.

Parameter	Explanation
Phase 1	Shows the voltage, current and power, which is being fed into or taken from the public grid.
Phase 2	
Phase 3	

■ Yield overview

Indicates the energy generated by the PV generators.

Parameter	Explanation
Day	Shows the yield values for the current day (from 00 to 24 hours).
Month	Shows all yield values for the current month (from day 1 to day 31).
Year	Shows all yield values for the current year (from 1 Jan. to 31 Dec.).
Total	Shows the total yield since commissioning.

■ Grid parameter

Shows the inverter's current grid parameters.

Parameter	Explanation
Current grid frequency [Hz]	Shows the grid frequency.
Current cos phi	Indicates the current power factor (cos phi).
Current power	Shows how much inverter power is being fed into the house grid.
Limitation on [W]	Shows the current power curtailment setting.

Home consumption menu

Shows the home consumption and from which sources the home consumption is being covered (solar generator, battery and public grid).

■ Current home consump.

Parameter	Explanation
Consumption	Current home consump.
From PV	Share of home consumption being covered by PV.
From grid	Share of home consumption being covered by the public grid.
From battery	Share of home consumption being covered from the battery.

■ Daily home consumption

Parameter	Explanation
Consumption	Home consumption of current day
From PV	Share of home consumption that has been covered by PV.
From grid	Share of home consumption that has been covered by the public grid.
From battery	Share of home consumption that has been covered from the battery.

■ Monthly home consumption

Parameter	Explanation
Consumption	Home consumption of current month
From PV	Share of home consumption that has been covered by PV.
From grid	Share of home consumption that has been covered by the public grid.
From battery	Share of home consumption that has been covered from the battery.

■ Degree of self-sufficiency

The degree of self-sufficiency indicates what percentage of the house's total power requirement is covered by self-generated PV energy. The higher the value, the less energy has had to be purchased from the energy supplier.

Parameter	Explanation
Day	Display for current day (from 00 to 24 hours)
Month	Display for current month (from day 1 to day 31)
Year	Display for current year (from 1 Jan. to 31 Dec.)
Total	Display for since initial commissioning

■ Self-consumption rate

The self-consumption rate shows the ratio between self-consumption and the total energy generated by the PV generators.

Parameter	Explanation
Day	Display for current day (from 00 to 24 hours)
Month	Display for current month (from day 1 to day 31)
Year	Display for current year (from 1 Jan. to 31 Dec.)
Total	Display for since initial commissioning

Battery menu

■ Battery status

If a battery is connected to the inverter, the current battery values are displayed here.

Parameter	Explanation
Charging status	Shows the battery's charging status (only when battery is connected).
Voltage	Shows the battery's voltage.
Charge / discharge current	A charging shows that the battery is being charged. A discharge shows that the battery is being discharged.
Number of cycles	Shows the battery's charging cycles.

PV generator menu (DC side)

Shows the current energy values of the DC side.

■ Current DC power

Shows the generated voltage, current and energy of the PV generators per DC input.

Parameter	Explanation
DC1	Shows the generated voltage, current and power of the PV generators for DC input 1
DC2	Shows the generated voltage, current and power of the PV generators for DC input 2
DC3	Shows the generated voltage, current and power of the PV generators for DC input 3. The values are only displayed if the inverter has a DC input 3 and if this has been configured as a PV input. If there is a battery connected to DC input 3, this is not shown.

5. Connection types

5.1	Connecting the inverter and computer	108
5.2	Settings on the computer	109
5.3	Connecting the inverter and computer	110
5.4	Disconnecting the inverter from the computer	112
5.5	Connection via KOSTAL Solar App	113

5.1 Connecting the inverter and computer

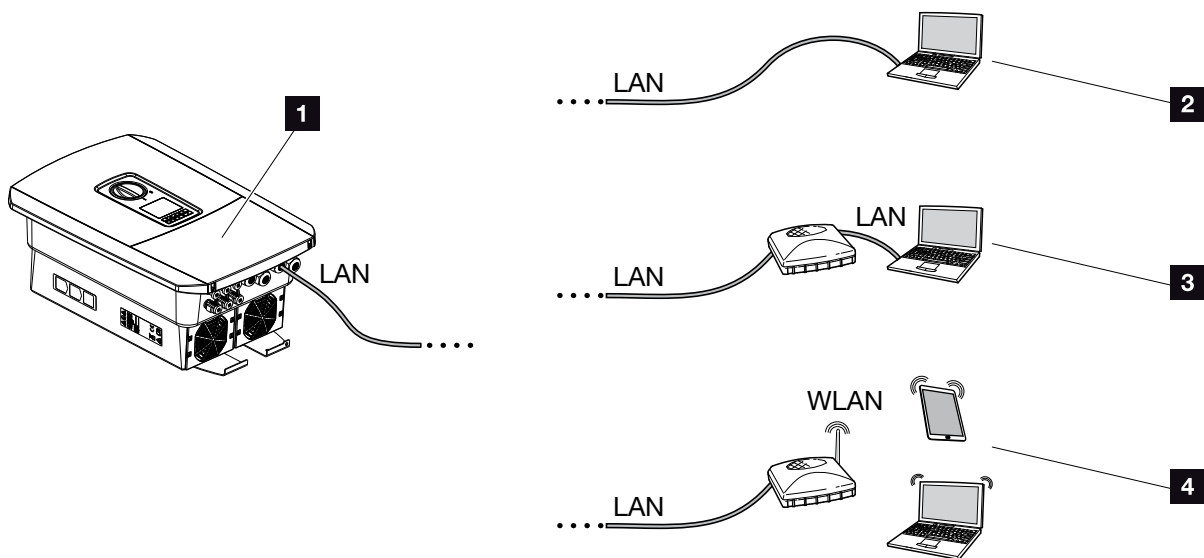

Fig. 50: Connection from computer to inverter

- 1** Inverter with LAN interface
- 2** Direct connection via LAN
(only with manual IP configuration)
- 3** LAN connection via switch/hub/router
- 4** WLAN connection via WLAN router

The inverter can be contacted via a computer or tablet using various types of connection for the purposes of configuration or data retrieval. Several settings should be noted here. These are explained in more detail on the following pages.

For settings relating to the router or Internet, please contact the provider of the router, your provider or a network specialist. **i**



INFO

If the inverter is to be accessed via the Internet, this shouldn't take place using unencrypted HTTP access (port 80).

Instead, preference should be given to encrypted access via HTTPS (port 443) and a VPN connection.

5.2 Settings on the computer

The items listed below relate to the Windows 10 operating system.

- In the Internet protocol (TCP/IP) of the computer, the options “Automatically acquire IP address” and “Automatically acquire DNS server address”, must be activated. 

You can go to the settings for the Internet protocol (TCP/IP) via the control panel:

Control Panel >> Network and Sharing Center >> Change Adapter Settings.

Right-click on the LAN connection >> Properties >> Select “Internet protocol (TCP/IPv4)” > Properties.

- In the LAN settings of the computer, the option “Use proxy server for LAN” must be deactivated.

You can reach the “LAN settings” via the control panel:

Control Panel >> Internet options >>

Tab: “Connections” >> LAN settings.



INFO

If the computer can already access the network in which the inverter is installed, these settings are not required.

5.3 Connecting the inverter and computer

This variant is mainly used when configuring the inverter by means of the Webserver on site **!**

1. De-energise the inverter's terminal compartment. **⚠**
2. Remove the inverter's cover.
3. Remove the terminal compartment's cover.

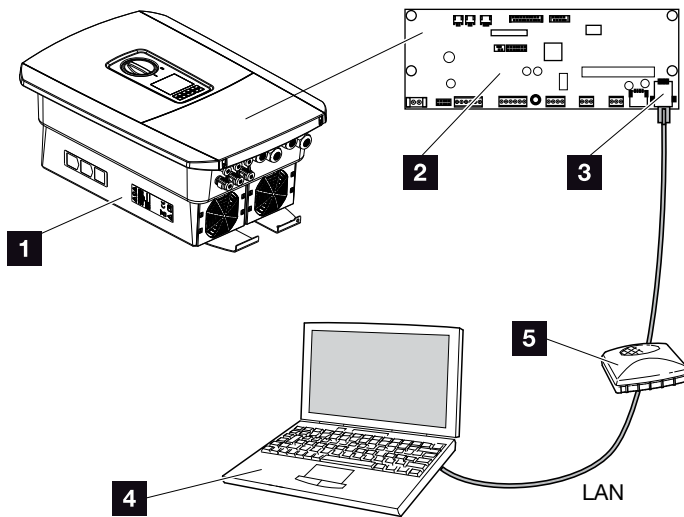

Fig. 51: Connecting inverter and computer with an Ethernet cable

- 1 Inverter with terminal compartment
 - 2 Smart Communication Board with LAN interface
 - 3 Ethernet cable (LAN)
 - 4 Computer (for configuration or data retrieval)
 - 5 Router
4. Insert Ethernet cable into the inverter and seal with sealing ring and union nut. Tighten union nut to the prescribed torque. Torque: 8 Nm (M25).
 5. Connect Ethernet cable to LAN interface of Smart Communication Board.



IMPORTANT INFORMATION

Use a patch cable of category 6 (Cat 6e) with a maximum length of 100 m.



DANGER

RISK OF DEATH DUE TO ELECTRICAL SHOCK AND DISCHARGE!

De-energise device and secure against being switched on again.

➔ Ch. 4.3

6. Connect Ethernet cable to a router or computer. 
 7. Close cover of terminal compartment and inverter (2.0 Nm).
 8. Activate fuses and DC switch.
- ✓ The inverter is connected to the computer.





INFO

If the inverter is connected directly to the PC and if the inverter has not yet received its own IP address via a DHCP server, an IP address needs to be configured manually in the inverter. This can then be entered into the browser's address line on the PC to access the Webserver.

Connecting the Ethernet cable to a router integrates the inverter into your own network, and the inverter can then be contacted by all computers incorporated in the same network.

5.4 Disconnecting the inverter from the computer

1. De-energise the inverter's terminal compartment.
 **Ch. 4.3** 
 2. Remove cover of inverter and terminal compartment.
 3. Unplug the Ethernet cable from the inverter and computer. 
 4. Close the inverter cover.
 5. Activate fuses and DC switch.
- ✓ The inverter is once again in operation.



DANGER

RISK OF DEATH DUE TO ELECTRICAL SHOCK AND DISCHARGE!

De-energise device and secure against being switched on again.

 **Ch. 4.3**



TIP

Leave the Ethernet cable connected to the inverter. This makes it possible to easily carry out further queries or setting configurations on the inverter.

If connecting through a router, for example, there is no need to remove the connection.

5.5 Connection via KOSTAL Solar App

The free KOSTAL Solar App provides you with a way of professionally monitoring your photovoltaic system. You can use the KOSTAL Solar App to simply and easily access all functions on your smartphone or tablet at any time.

To set up and use the app, you will need access to the KOSTAL Solar Portal and to have an inverter set up there. The same access data used for the KOSTAL Solar Portal is required to log into the app.

You can use the KOSTAL Solar App to easily monitor your photovoltaic system and to display relevant system data both when you are out and about and at home. It allows you to access the consumption and generation data over various time periods, such as day, week, month and year, and to access the historical data of your photovoltaic system. So you are always up-to-date with the KOSTAL Solar App.

Download the free KOSTAL Solar App today and benefit from new and advanced functionalities.