

6. Webserver

6.1	The Webserver	115
6.2	Calling up the Webserver	117
6.3	Menu structure of Webserver	119
6.4	Webserver menus	124
6.5	The battery use strategy	153
6.6	Smart battery control	155

6.1 The Webserver

Webserver - start screen

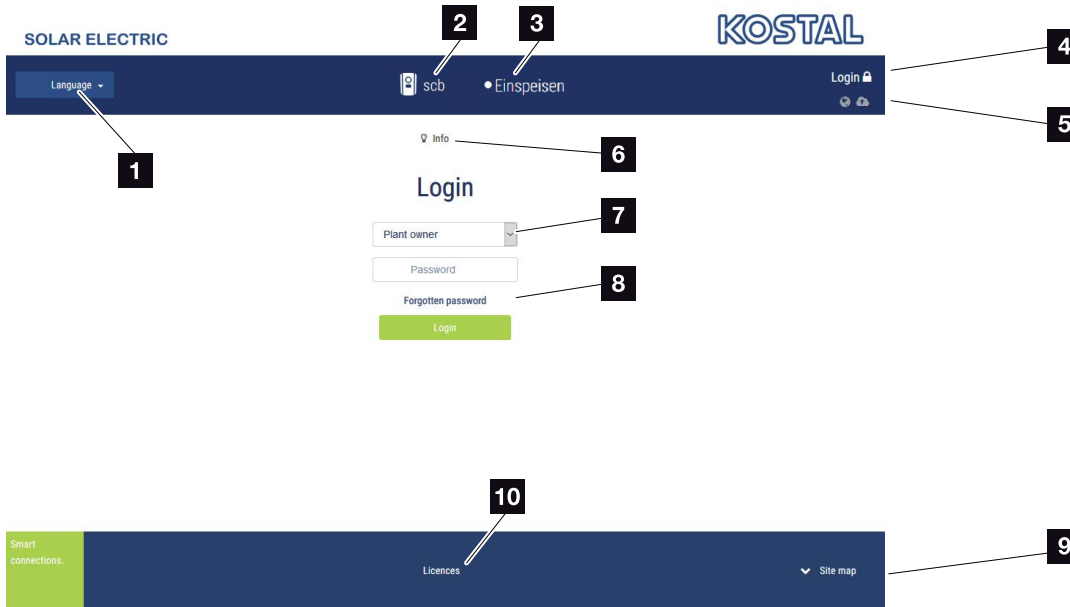

Fig. 52: Webserver - start screen

- 1 Language selection
- 2 name of the inverter
- 3 Inverter status message
- 4 Webserver login/logout
- 5 Status messages
 - Globe symbol: Status of solar portal connection
 - Download symbol: Software update
- 6 Retrieval of device information
- 7 Login as plant owner or installer
- 8 The user can assign a new password for the Webserver with the "Forgotten password" button or create a new password generally for logging in for the first time.
- 9 Access to sitemap
- 10 Information about licences

The Webserver forms the graphic interface between the inverter and user. Even if you don't log in, here you can find information about your PV system, This includes, for example, the device information and the current status of the inverter. Go to Login to log in as plant owner or installer. **!**



IMPORTANT INFORMATION

To log in as a plant owner, you need a password, which has to be generated for the first login using "Forgotten password?". For this, you also need the master key from the type plate.

To log in as an installer, you need the master key from the inverter's type plate and your service code, which can be requested from our service team. **Ch. 14.2**

Webserver - menus

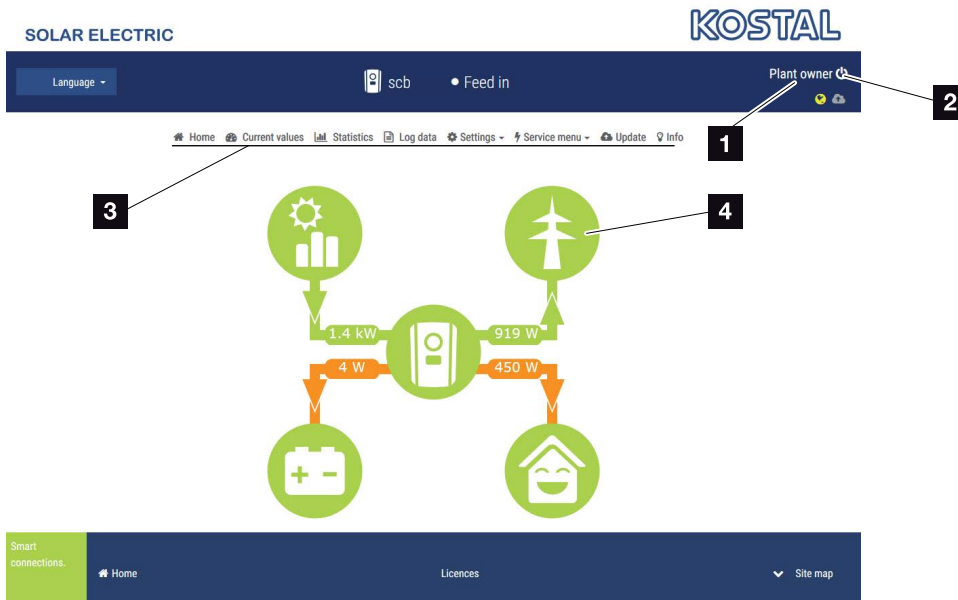

Fig. 53: Webserver - menus

- 1 User logged in
- 2 Logout from the Webserver
- 3 Inverter menus
- 4 Energy flow diagram

Once you have logged in as plant owner or installer, you can choose from various menu items. **i**

The Webserver allows the user to view key information, current values, events and inverter versions.

The statistics provide an overview of yield and remuneration.

The Settings and Service menu allow the inverter to be configured quickly and easily. More information about the inverter can be found under Log data.

On the next few pages, you will find details of how to log into the Webserver and explanations of individual menu items.





INFO

Depending on user role (installer or plant owner), different menu items can be accessed.

Deviations in the appearance of the Webserver and the menu items described here may be possible due to different software versions (UI version).

6.2 Calling up the Webserver

The Webserver is accessed on the inverter from a computer using a web browser (e.g. Internet Explorer, Firefox or Google Chrome). Both devices must be on the same network. 

Information about the connection and settings on the computer  **Ch. 5.**

A user can log into the Webserver as a “Plant owner” or “Installer” using **Login**.

To log into the Webserver as an installer, you will need a personal service code and the master key for the inverter (can be found on the inverter’s type plate). After logging in, the installer can access advance setting options, which are not available to the normal plant owner. These settings require specialist knowledge. 

Use **Logout**  to log out of the Webserver.



TIP

Any device (e.g. a tablet PC) that has a browser can be used to access the Webserver.





INFO

You can request a service code from our service team.
 **Ch. 14.2**

Logging into the Webserver

Launch an Internet browser.

1. Enter the IP address of the inverter in the address line of the browser and confirm with “Enter”. 
- The Webserver is called up.
2. As the plant owner, log in with your password. 

If you want to log in as an installer, enter the following data:

Master key: Master key from type plate

Service code: Installer’s service code

Confirm the hazard notice and exclusion of liability.

- The Webserver’s menu opens.

Making settings in the Webserver

After logging in, the settings required via the Webserver can be made on the inverter or the inverter’s values can be queried.



TIP

The IP address is shown alternately in the inverter display or can be queried in the inverter menu.



IMPORTANT INFORMATION

To log in for the first time as a plant owner, you first have to have a password. This can be obtained using “Forgotten password”. In the following menu, enter the master key and a new password. You will find the master key on the inverter’s type plate.

The password must comprise at least 8 characters and include the following combination of characters: a-z, A-Z, 0-9

Should you forget your password, it can be re-assigned in the same way.

6.3 Menu structure of Webserver

Deviations due to software versions (UI status) possible.

Home menu

 Home ————— Display of power flow diagram

Current values menu

 Current values —————

- PV generator ————— Shows voltage, current, power for each DC input
- Inverter ————— Shows inverter status and active events
- Home consumption ————— Shows the home consumption and the sources from which the home consumption is being covered (solar generator, battery or public grid).
- Grid ————— Shows voltage, current, power per phase and the grid parameters
- Battery ————— If a battery is connected to the inverter, the current battery values are displayed here

Statistics menu

 Statistics —————

- Daily yield ————— Shows yield for current day
- Monthly yield ————— Shows yield for current month
- Annual yield ————— Display of yield for current year
- Total yield ————— Display of total yield

Log data menu

 Log data ————— Log data ————— Download log data from inverter

Settings menu

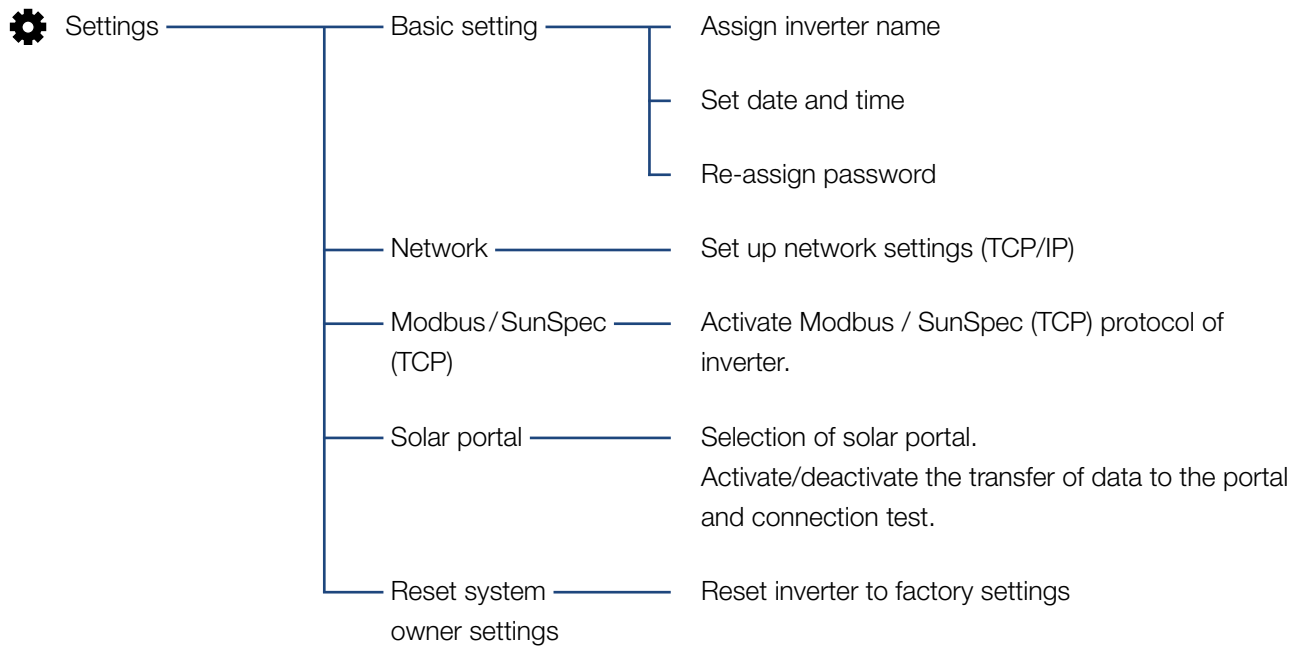

Service menu – general

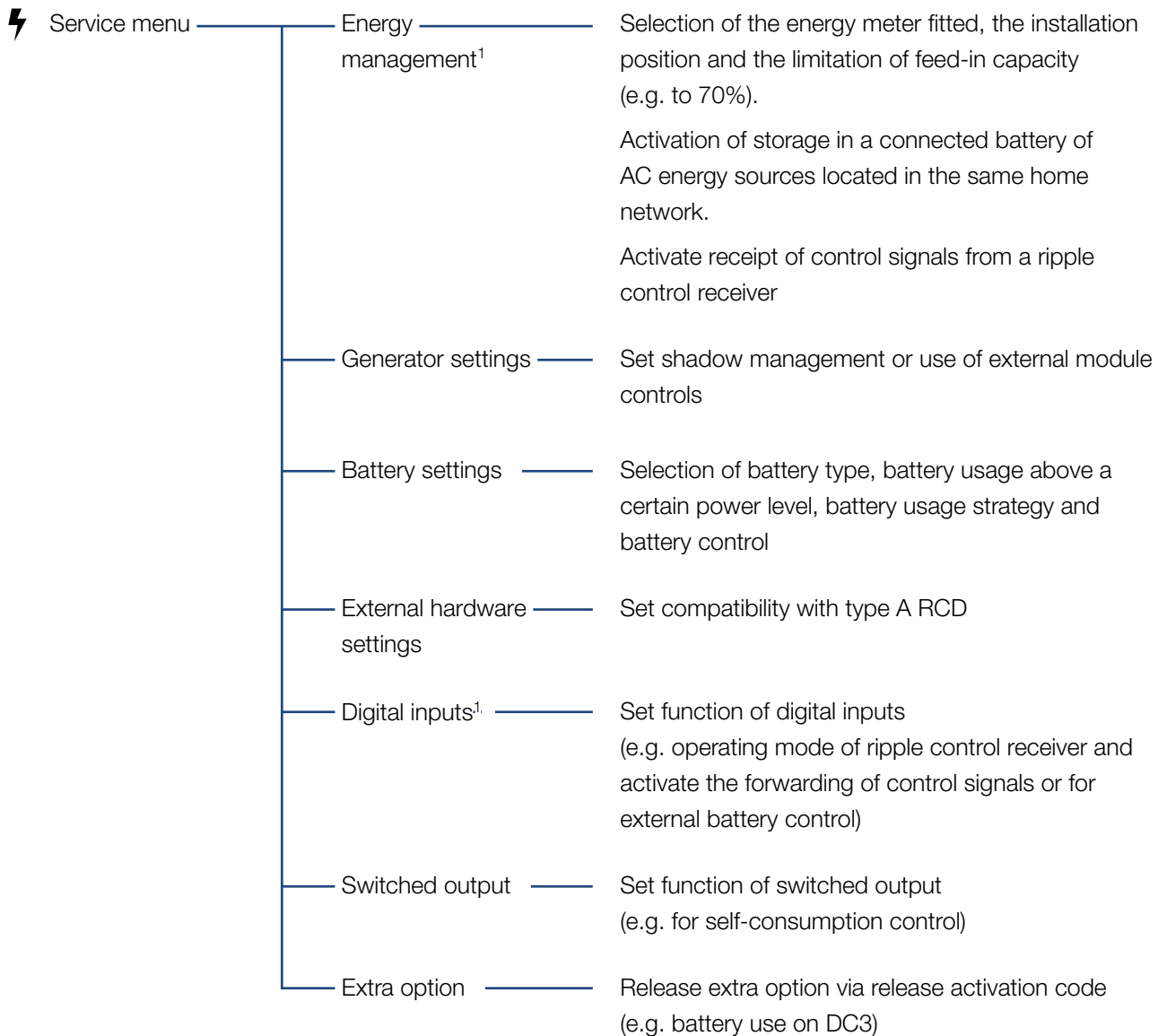

¹ Can only be changed with a service code

Service menu – grid parameterization

 Service menu	Parameterization report	Overview of parameters set in the inverter
	Reactive power settings ¹	Configuration of reactive power ¹
	Start-up ramp ¹	Configuration of start-up ramp in event of start or grid error ¹
	LVRT/HVRT ¹	LVRT/HVRT ¹
	P(f) ¹	Configuration of power reduction at overfrequency P(f) ¹
	P(U) ¹	Configuration of power reduction at overvoltage P(U) ¹
	Settling time ¹	Configuration of settling time Setting the settling time with external control of reactive power or active power by means of ripple control receiver or Modbus
	Grid and system protection ¹	Grid and system protection ¹ Configuration of grid and system protection: Voltage L-N, frequency, start-up voltage, start-up frequency, start-up waiting time for start, start-up waiting time for grid error ¹
	Grid and system protection self-test	Self-test for grid and system protection Runs a self-test and outputs the result of this

¹ Can only be changed with a service code

Update menu

 Update ————— Update ————— Perform inverter software update

Info menu

 Info ————— Device information ——— Shows device and network information as well as events that are pending in the inverter.

6.4 Webserver menus

The following menus are available to the user in the Webserver. You will find a more detailed description of the individual points on the following pages:

- **Home**
Shows power flow diagram
- **Current values**
Using various statistics, the user can display the current values for daily, monthly, annual and total yield. Detailed information can be displayed by expanding the statistics.
- **Statistics**
Shows information about the inverter's yield data for daily, monthly, annual or total time periods.
- **Log data**
Here the inverter's log data can be downloaded in total or for a limited time period.
- **Settings**
These menu items can be used to configure the basic settings for the inverter (e.g. inverter name, network settings, specifications relating to remuneration, retrieval of log data).
- **Service menu**
These menu items can be used by the installer to configure the inverter's hardware (e.g. active power reduction or also special grid settings which have been specified by the energy provider).

- **Update**

This menu item can be used to update the inverter by means of a software update.

- **Info**

On the Info page the user can view events pending in the inverter or the inverter's installed versions (e.g. UI, MC, IOC, HW). This information can also be viewed without logging into the Webserver.

Webserver menu - home

■ Home

Shows the power flow diagram. The directions of flow for the energy to and from the inverter are shown. The values indicate the power currently present.

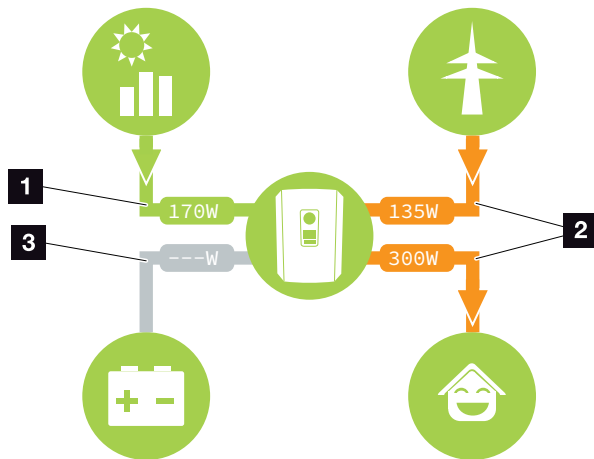

Fig. 54: Energy flow diagram

- 1 Green: Energy is being supplied
- 2 Orange: Energy is being purchased/consumed
- 3 Grey: No energy flow

Webserver menu - current values

Menu items to display the current energy values of the AC and DC side.



■ PV generator

Shows the generated voltage, current and energy of the PV generators per DC input.

Parameter	Explanation
DC input x	Shows the generated voltage, current and power of the PV generators per DC input.

■ Inverter

Shows the current status of the inverter, current performance data of the grid side (AC) and how the energy is distributed to the phases.

Parameter	Explanation
Status	Operational status of inverter. For more information, see  Ch. 4.5.
Digital inputs	Signal status of terminal for digital interface for ripple control receiver (input 1-4). The display shows whether the feed-in is currently limited, e.g. by the energy supplier or by an external battery management system. Settings, e.g. for user-defined active/reactive power reduction can be made by going to Service menu > Digital inputs.  Ch. 9.1.
Output power	Shows how much inverter power is being fed into the home network.
Grid frequency	Shows the current grid frequency
Cos phi	Indicates the current power factor (cos phi)

Parameter	Explanation
Limitation on	Shows the current power curtailment setting. If an energy meter (e.g. a KOSTAL Smart Energy Meter) is fitted in the home network and power limitation is set, the active power is dynamically limited taking account of home consumption. This means that in addition to the set power curtailment, the home consumption is added up to the max. power limit of the inverter.
Phase x	Shows the power values per phase (x = 1, 2 or 3)

■ **Home consumption**

Shows the current home consumption and the sources from which it is being covered.

Parameter	Explanation
Current home consumption covered by	Shows the home consumption and the source from which it is currently being covered.

■ **Grid**

Shows the current performance data of the grid side (AC).

Parameter	Explanation
Grid	Feed-in: PV energy is fed into the public grid. Purchase: Energy is purchased from the public grid to cover home consumption.

■ Battery

If a battery is connected to the inverter (only possible if DC3 has been released), the current battery values are displayed. 

Parameter	Explanation
Status	Charge: The battery is charged Discharge: Energy is drawn from the battery.
Voltage	Shows the battery's charge/discharge voltage.
Current	Shows the battery's charge/discharge current.
Power	Shows the battery's charge/discharge power.
Charging status	Shows the battery's charging status in %.
Charging cycles	Shows the battery's charging cycles.



INFO

If all values are at zero, the battery is in sleep mode. You can check the status of the battery by going to Current values > Inverter.

Webserver menu - statistics

Shows the yield for the day, month, year and total.

■ Yield statistics

Shows the yield/consumption values.

Parameter	Function
Day	Shows the yield/consumption values for the current day.
Month	Shows the yield/consumption values for the current month.
Year	Shows the yield/consumption values for the current year.
Total	Shows all yield/consumption values that have accumulated in the inverter.
Diagram	<p>Self-consumption: The self-consumption shows the energy consumed by the user as a proportion of the total energy generated.</p> <p>Degree of self-sufficiency: The degree of self-sufficiency indicates what percentage of the house's total power requirement is covered by self-generated PV energy. The higher the value, the less energy has had to be purchased from the energy supplier.</p>
CO ₂ saving	Shows the purely arithmetical CO ₂ saving that has been saved by the PV energy generated.
Home consumption	<p>Shows the home consumption.</p> <p>From PV: Shows how much PV energy has been used for home consumption</p> <p>From grid: Shows how much energy has been obtained from the public grid</p> <p>From battery: Shows how much energy from the battery has been used for home consumption</p>

Webserver menu - log data

Call-up the log data from inverter. 

Menu item	Function
Log data download	Restricted time period: Download a selected time period of log data from the inverter (max. 100 days).

The log data of the inverter can be downloaded as a file (logData.csv). The data in the file is in CSV format and can be viewed with any spreadsheet program (e.g. Excel).

For more information, see  **Ch. 7.2.**

The data is saved on your hard drive. After saving, this data can be displayed and further processed. 



INFO

The data is saved in the inverter for around 365 days. When the internal memory is full, the oldest data will be overwritten.



INFO

If the inverter is not connected to a solar portal, regular backup copies of the log data should be created.

Webserver menu - settings

In Settings you can configure the inverter and the external components (e.g. ripple control receiver etc.).

■ Basic settings

Set the general parameters of the inverter.

Inverter name

Set the general parameters of the inverter.

Menu item	Function
Inverter name	Input of inverter name (max. 63 characters). The following characters are permitted: a–z, A–Z, 0–9 and “-”. Spaces or special characters are not possible. The browser connection to the Webserver can be established with the new name following the name change or can continue using the IP address.

■ **Time setting**

Set time/date or select a time server.

Menu item	Function
Date and time	Input of time / date. The time can be taken from the PC.
Time zone	Set the time zone (e.g. UTC (+1:00) for CET)
Activate time server	Activate/deactivate a timer server (NTP server). After activation, the time from the time server is used. By using the NTP server, the switch between summer and winter time is also performed automatically.
NTP server	Input of IP address or name of NTP server (Network Time Protocol). Other, alternative NTP servers can be added via Plus. There are numerous free NTP servers in the Internet, which can be used here.



Change password

Change Webserver password.

Menu item	Function
Change password	Change Webserver password. The password must comprise at least 8 characters and include the following combination of characters: lower-case letters (a-z), upper-case letters (A-Z) and numbers (0-9).

■ **Network**

Set the communication parameters of the inverter.

Menu item	Function
Automatically acquire IPv4 address	If the box is ticked, the IP address is generated automatically by a DHCP server. Most routers provide a DHCP server as standard. 
IPv4 address (only with manual configuration)	Enter the IP address of the inverter 
Subnet mask (only with manual configuration)	Enter the subnet mask e. g. 255.255.255.0
Router/gateway (only with manual configuration)	Enter the IP address of the router
DNS server 1 (only with manual configuration)	Enter the IP address of the DNS server (Domain Name System)
DNS server 2 (only with manual configuration)	Enter the IP address of the backup DNS server (Domain Name System)

■ **Modbus / SunSpec (TCP)**

Activate the protocol, which can be used in the inverter to exchange data with external data loggers, linked to the inverter via the LAN interface.

Menu item	Function
Activate Modbus	Output of port (1502) and ID (71) parameters for Modbus / SunSpec. Activate the protocol on the LAN TCP/IP interface. Used for an external data logger, for example. No further settings are needed.



INFO

The “Obtain IP address automatically” option is activated by default. This means that the inverter obtains its IP address from a DHCP server.



INFO

If the inverter is not allocated an IP address automatically through a DHCP server, the inverter can be configured manually.

The data necessary for configuration, such as IP, subnet mask, router and DNS addresses, can be found on your router/gateway.

■ **Solar portal**

Input of solar portal configuration. If you want to use a solar portal, the log data and events can be sent to the solar portal. 

Menu item	Function
Use portal	Activates the transfer to the solar portal.
Portal	Selection of solar portal.
Last transfer	Indicates when the inverter last transferred data to the solar portal (provided the function is active).
Last successful transfer	Indicates when the inverter last successfully transferred data to the solar portal (provided the function is active).



INFO

The solar portal can only be used for inverters, which are linked to the Internet.

■ **Reset system owner settings**

Reset system owner settings to factory settings.



Menu item	Function
Reset system owner settings	The values for the basic settings, network, Modbus/SunSpec and solar portal are reset to the factory settings.

Webserver menu - Service menu - General

In the service menu, the installer will find more configuration options for configuring the inverter. In order to configure these settings, precise knowledge is needed of the requirements of the public grid specified by the energy supply company (e.g. reduction of active power, setting of parameters specified by the energy supply company). 

■ Energy management (can only be configured with service code)

Selection of the connected energy meter on the inverter and the feed-in limitation to the public grid. 

Menu item	Function
Energy meter	Selection of connected energy meter.
Sensor position	Select the position of the energy meter fitted in the building services  Ch. 3.6 Grid connection point = position 2 Home consumption = position 1
Limitation of the active power to [W]	Set the max. feed-in capacity. Requirements relating to this are generally specified by the energy supply company (e.g. a limitation to 70%). The inverter's max. power serves as the default. Use the calculator to easily calculate the reduction.
Storage of excess AC energy from local generation	If there is an additional AC energy source in the local home network (e.g. an additional PV system or a combined heat and power unit), the AC energy generated by this source can be stored in a battery connected to the PLENTICORE plus.  Activated: The AC energy generated can be stored in the battery. Deactivated (default): Extra generated AC energy is not stored in the battery.



INFO

The settings in this menu requires special knowledge of the grid configuration.



INFO

A list of approved energy meters and their purpose are available in the download area for the product on our homepage at www.kostal-solar-electric.com



INFO

The function can only be activated if the energy meter has been installed at the grid connection point (position 2) and there is a battery connected to the inverter.

Menu item	Function
Activate receipt of broadcast control signals	<p>If there is a ripple control receiver connected to another inverter's digital inputs, these signals can be allocated to all inverters in the local area network (LAN) for active and reactive power control by means of UDP broadcast. A local energy manager can also generate signals for active and reactive power control in the local area network.</p> <p>Activated: The inverter is controlled by means of a ripple control receiver connected to another inverter.</p> <p>Deactivated (default): The signals are not evaluated. The inverter is not controlled by means of a ripple control receiver connected to another inverter.</p>

■ **Generator settings**

Settings for MPP tracking optimisation.

Menu item	Function
Generator settings	<p>None: No optimisation is perform.</p> <p>Shadow management: If PV strings are in partial shading, the PV string affected no longer achieves its optimum performance. If shadow management is activated, the inverter adapts the MPP tracker of the selected PV string such that it can operate at maximum possible performance.</p>

■ **Battery settings**

If a battery is connected to the inverter, its behaviour and usage of the battery can be configured here. 

Parameter	Function
Battery type	Selection of battery connected to inverter. 
Battery usage from a grid demand of xxx W	Input of a minimum grid demand value from which the battery is used. (Standard 50 W.) Example: If a value of 200 W is set, the battery can only be released to cover the home consumption when the measured grid demand from the public grid exceeds 200 W. The battery is blocked again for home consumption when the grid demand falls 50 W below the set value (in this example 150 W).
Battery charge from excess energy as from [W]	Input of a minimum value. From this value on, the battery is charged as from excess AC energy from the house grid (default 0 W). Example: If a value of 200 W is set, the battery will be charged as soon as the energy meter measures an excess of AC energy in the house grid of more than 200 W. The battery is blocked again for storage when the value falls below 50 W of the set value (here in the example 150 W).





IMPORTANT INFORMATION

If a battery is set up at a later date via the Webserver or inverter, use the DC switch to switch the inverter off and on again after configuration so that the settings are adopted.



INFO

You will find a list of approved battery storage systems in the download area for the product on our homepage at www.kostal-solar-electric.com

Parameter	Function
Battery use strategy	<p>Select battery use strategy.</p> <p>The following modes are available: automatically (standard), automatically economical.</p> <p>Automatically: </p> <p>The inverter controls the battery charge automatically depending on the generated PV energy. In this mode, the battery is not switched off.</p> <p>Automatically economical: </p> <p>The inverter controls the battery charge automatically, but switches the battery off if there is not enough PV energy available to charge the battery for long periods.</p>





INFO

This setting is recommended for regions with little snowfall.



INFO

This setting is recommended for regions with a lot of snowfall.

Parameter	Function
Battery control	<p>The battery can be controlled by an external battery management system (e.g. energy supplier). In this case, the charge/discharge capacity of the battery is controlled by the external supplier. The plant owner then receives remuneration for the energy provided, e.g. from the external supplier  Ch. 8.1.</p> <p>Internal (standard): The external control is deactivated.</p> <p>Via Modbus (TCP): The external battery management is provided via the Modbus RTU protocol. The control signals are received via the LAN interface. If there are no control signals, the system switches to internal control. Interrogation of the device status via Modbus (TCP) / SunSpec is still possible in parallel.</p> <p>Via digital I/O: External battery management is carried out via the digital inputs on the Smart Communication Board (terminal X401) of the inverter. A presetting can be selected or the digital inputs can be configured according to the provider's specifications. If there are no control signals, the system switches to internal control. Interrogation of the device status via Modbus (TCP) / SunSpec is still possible in parallel  Ch. 8.1.</p>
Min. charging status (SoC) [%]	<p>Set the minimum depth of discharge of the battery. </p> <p>If the "Smart battery control" is also activated, a "Dynamic" depth of discharge can also be selected. In this case, to make optimum use of the battery, the depth of discharge is automatically adapted depending on the weather and forecast.</p>





INFO

Setting the depth of discharge allows you to keep a reserve in the battery.

For example, a value of 100% prevents the battery from having to be continually recharged from the grid in the winter because the battery cannot be charged using PV energy.

A value of 100% is the equivalent of a fully charged battery.

Parameter	Function
Smart battery control	<p>Charging and discharging of the battery are controlled completely automatically here. This function should only be activated if the connected PV power is greater than the PV power of the inverter (limitation on of inverter set e.g. to 70%). This function should not be activated if the “Storage of excess AC energy from local generation” function has been activated.</p> <p>You can find a detailed description in chapter  Ch. 6.6</p>
Time-controlled battery usage	<p>The charging and discharging operation can be configured very flexibly at different times (tariff periods).</p> <p>There are times when the costs of electricity procurement are relatively high (different tariff models). It may therefore be useful to allow the battery to be discharged during these periods and to allow charging (also from the grid if permitted by the grid operator) outside these periods.</p> <p>The times set here can be overridden by the specifications of an activated external battery management system.</p> <p>Battery charge blocked: battery discharge permitted in the event of demand from house.</p> <p>Battery discharge blocked: battery charge permitted in the event of excess power.</p>
Reset battery mode (only possible with service code)	<p>This function resets the battery’s winter mode (sleep mode 1 or 2) until the next inspection. </p>



INFO

This function is needed if e.g. a battery module is being exchanged in the winter in order to charge and check the function of this module.

■ **External hardware settings**



Settings for hardware settings.

Menu item	Function
Residual current protection equipment	<p>Compatibility of type A RCD:</p> <p>If this function has been activated, type A RCDs can be used as residual current protection equipment. In such cases, the inverter shuts down when the residual current becomes incompatible for a type A RCD.</p> <p>If the function is deactivated, a type B RCD must be used as residual current protection equipment if a RCD is stipulated.</p>

■ **Digital inputs**

(can only be configured with service code)



Selection of the use of digital inputs on the Smart Communication Board (terminal X401).

Menu item	Function
none	There is nothing connected to the digital inputs.
External trip input	Setting for external switch-off via trip signal. A voltage VDD is applied here to input 1 for trip signal. 
Parameter set changeover	<p>Setting for local switching via parameter set. A voltage VDD is applied at input 3. The parameter set is then activated as soon as there is also voltage at input 2 .</p> <p>The shutdown limits that can be activated for changeover via parameter set must be set for this purpose under Grid and system protection. </p>



INFO

Please note for Italy that the connection with an external voltage source and a changeover switch to GND is mandatory.

Menu item	Function
External trip and parameter set changeover	<p>Setting for external changeover via parameter set. A voltage VDD is applied at input 2. The set parameter is activated as soon as there is also voltage at input 3 .</p> <p>The shutdown limits that can be activated for changeover via parameter set must be set for this purpose under Grid and system protection. </p>
External battery control	<p>If you have activated external control via the digital I/O ports in the “Battery settings” menu, you can define the functions of the inputs here. Assign the desired charge or discharge power to the inputs.</p>
Active power control	<p>For the connection of a ripple control receiver with standard switching specifications.</p> <p>Detailed description in chapter Self-consumption.  Ch. 9</p> <p>Activate the distribution of ripple control signals in the home network.</p> <p>Activated: If a ripple control receiver is connected to the inverter, the control signals of this ripple control receiver are distributed in the local LAN network by means of UDP. Other inverters can therefore also be controlled using the connected ripple control receiver.</p> <p>Deactivated: The control signals are not distributed in the local LAN network by means of UDP.</p>

Menu item	Function
User-defined active/reactive power control	<p>For the connection of a ripple control receiver. Unlike the standard active power control, here you can specify up to 16 settings. This is usually specified by the energy supply company.</p> <p>Detailed description in chapter Self-consumption.  Ch. 9</p> <p>Activate the distribution of ripple control signals in the home network.</p> <p>Activated: If a ripple control receiver is connected to the inverter, the control signals of this ripple control receiver are distributed in the local LAN network by means of UDP. Other inverters can therefore also be controlled using the connected ripple control receiver.</p> <p>Deactivated: The control signals are not distributed in the local LAN network by means of UDP.</p>

■ **Switched output**

Set the function of the self-consumption terminal (terminal X461) on the Smart Communication Board. The 2-pin terminal can be assigned various functions.

Parameter	Function
Self-consumption control or Dynamic self-consumption control	The switched output functions as a potential-free NO switch. It closes when the set conditions are fulfilled. Detailed description in chapter Self-consumption.  Ch. 3.14

■ **Extra options**

This function can be used to release additional options for the inverter. This may be e.g. releasing the DC3 input to connect battery storage.

Parameter	Explanation
Release new option	Input of an activation code, e.g. to connect a battery. This first has to be purchased from the KOSTAL Solar online shop. 
Released options	Overview of options currently released in the inverter



INFO

The activation code can be purchased from the KOSTAL Solar online shop.

To visit the shop, go to shop.kostal-solar-electric.com

Webserver menu - Service menu - Grid parameterisation

The following menu items can be used to set the parameters in the inverter, which are specified by the grid operator.

Parameters may only be changed on the inverter by qualified electrical technicians who are familiar with the system and at the request of the grid operator.

Inappropriate settings can be hazardous and lead to injury or even death of the user or third parties. Material damage to the device and other equipment can also occur.

- **Show parameterization report**
Issues an overview of the parameters set in the inverter.
- **Reactive power settings**
(can only be configured with service code)

The following selection options are available:

Parameter	Function
No reactive power mode active	No reactive power is set.
Reactive power Q	The grid operator (energy supply company) specifies a fixed reactive power in Var.
Displacement factor $\cos \phi$	The grid operator specifies a fixed displacement factor $\cos \phi$.
Reactive power / voltage characteristic curve Q(U)	The grid operator specifies a characteristic curve Q(U).
Displacement factor / power curve $\cos \phi$	The grid operator specifies a characteristic curve for $\cos \phi$ (P).



IMPORTANT INFORMATION

The settings may only be adjusted by trained and qualified electrical technicians.

The electrician is responsible for ensuring that the applicable standards and regulations are observed and implemented. Work that could affect the electrical power system of the respective energy supply company at the site of the solar energy feed-in may only be carried out by qualified electricians expressly authorised (licensed) by the energy supply company.

This includes changes to the factory preset parameters of the inverter.

■ **Configuration of the start-up ramp
(can only be configured with service code)**

Parameter	Function
Ramp time [s]	States the time in seconds after a restart or grid error for which the inverter waits before starting up. The ramp time is also used for P(f) and P(U).

■ **Configuration of LVRT/HVRT
(can only be configured with service code)**

Parameter	Function
LVRT	Configuration of Low-Voltage-Ride-Through LVRT is the electrical ability to provide dynamic grid support through electrical generation units.
HVRT	Configuration of High-Voltage-Ride-Through HVRT is the electrical ability to provide dynamic grid support through electrical generation units.

■ **Configuration of power reduction at overfrequency P(f)
(can only be configured with service code)**

Parameter	Function
Reduction curve	The characteristic curve is defined by a change in frequency which is expressed as a percentage of the rated frequency and causes a 100% change in rated output.
Conditions for returning to normal mode	Input of frequency range and waiting time in seconds

■ **Configuration of power reduction at overvoltage P(U)
(can only be configured with service code)**

Parameter	Function
Reduction curve	The characteristic curve is defined by a voltage start and end point. The power is reduced by 0% at the start point and by 100% at the end point.
Settling time	Selection of the settling time
Conditions for returning to normal mode	The reduction in power ends once the voltage has fallen below the specified value and the stated waiting time has passed.

■ **Settling time**
(can only be configured with service code)

Set the settling time with external control of reactive power or active power by means of ripple control receiver or Modbus.

Parameter	Function
Settling time [s]	With external control of reactive power ($Q, \cos \phi$), the settling time can be set in seconds. Select the specifications of the grid operator (energy supply company) here.
Mode	With external control of active power, the following parameters can be set. Standard: no further details needed (default) PT1: Selection of the settling time in seconds. Power gradient: Input of maximum power limit gradient. Enter the specifications of the grid operator (energy supply company) here.

■ **Grid and system protection (can only be configured with service code)**

The settings for the grid and system protection may only be changed in exceptional cases for good reason and in consultation with the grid operator (energy supply company).

Parameter	Function
Shutdown limits for voltage	The settings for the grid and system protection may only be changed in exceptional cases for good reason and in consultation with the grid operator (energy supply company). Enter the specified values in the corresponding fields.
Shutdown limits for frequency	
Use switchable shutdown limits	
Start-up conditions	

■ **Self-test for grid and system protection**

Runs a self-test with the set values and produces the result of this.

Webserver menu - update

This function can be used to load software updates into the inverter. To do this, drag the update file (*.swu) into the box or use the button to select a file on your computer and launch the installation.

You will find the latest software for your product in the [Download area](#) on our homepage by going to Product category > Model > Country > Update.

Webserver menu - info

Displays all events and version numbers of the inverter.

■ Device information - devices

Provides information about the versions installed in the inverter. The information about the device can also be viewed without logging into the Webserver.

Function	Meaning
Name of device	Name of inverter. Can be changed by going to Settings > Basic settings.
Serial number	Inverter serial number
Article number	Article number of the inverter
UI	User interface version
MC version	Main controller software version
IOC version	I/O controller software version
HW version	Hardware version
Country setting	Shows the inverter's country setting
Battery input	Status of DC input 3 battery

■ **Device information - network**

Provides information about the specified network settings.

Function	Meaning
Network information	<p>Static The network settings were specified manually.</p> <p>DHCP The network settings are obtained automatically.</p>
IPv4 address	Shows the specified IP address of the inverter
Subnet mask	Shows the specified subnet address
Gateway	Shows the router/gateway address
DNS server	Shows the address of the 1st and 2nd DNS server (Dynamic Name Server)
Last connection to the solar portal	Last transfer in minutes or time

■ **Device information - events**

Up to 10 events can be displayed. Additional information about the event can be displayed via Info (i) next to the event.

6.5 The battery use strategy

Various variants of the charge strategy can be activated for a battery connected to the inverter.

“Automatically” functional mode

In “automatically” mode, the inverter itself controls how the battery is charged and discharged over the entire year. The battery is not switched off and is therefore available all year round.

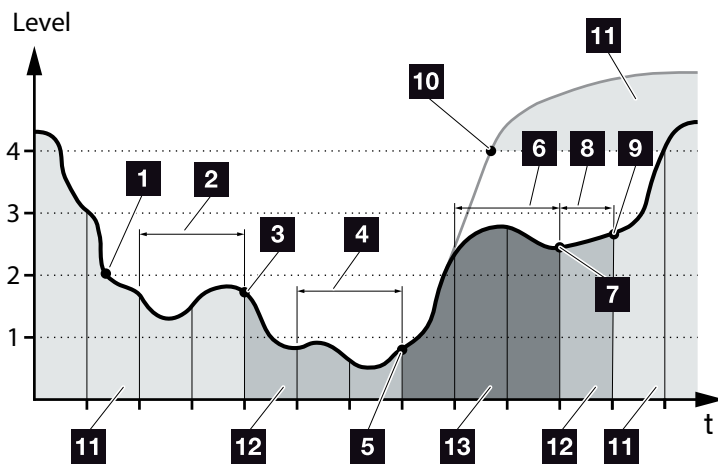



Fig. 55: Automatic mode

- 1** If the amount of PV energy generated daily is greater than level 2, the inverter is in normal mode. Here the battery is charged by the inverter using the PV energy available and energy can be released to consumers in the home network.
- 2** The amount of PV energy generated daily falls below level 2 for two days in succession
- 3** The inverter prohibits the battery from discharging. The battery receives trickle charges via the inverter provided there is no self-consumption from consumers in the home network. There is no longer any energy available from the battery. “Battery sleep mode 1” is displayed on the inverter.

- 4 The amount of PV energy generated daily falls below level 1 for another two days in succession
- 5 Initially the battery is charged using PV energy or, if this is not available, via the public grid. The inverter then prohibits the battery from charging and discharging. The “Battery sleep mode 2” message is output on the inverter.
- 6 The amount of PV energy generated is greater than level 2 for two days in succession or rises directly above level 3.
- 7 The battery is reactivated from sleep mode but energy can still not be drawn from the battery.
- 8 The PV energy remains above level 2 for another day.
- 9 The battery is switched into normal mode.
- 10 Should the PV energy rise above level 4, the battery is switched straight into normal mode.
- 11 Battery normal mode
- 12 Battery sleep mode 1
- 13 Battery sleep mode 2

“Automatically economical” functional mode

Unlike “Automatic” mode, the battery is switched off here as soon as the PV energy falls below level 1 for two days in succession  **Fig. 55, item 5.**

The “Battery sleep mode 2” message is output on the inverter.

Before the battery is switched off, it is charged.

6.6 Smart battery control

The PLENTICORE plus has a new kind of smart generation and consumption forecast and coupled with connected energy storage (a battery), this provides the consumers in the home with generated power in an optimum manner.

Using this form of control allows the majority of the photovoltaic energy produced to be used by the consumer and therefore helps to cut electricity costs.

The smart generation and consumption forecast recognises and takes account of the times when the household uses the most energy. The system uses this information to make forecasts about how home consumption will change in the future and controls charging/discharging of the battery accordingly. This ensures that the greatest amount possible of self-produced energy is used in the house and as little energy as possible is fed into the public grid unused.

By using the smart generation and consumption forecast, usage of the generated energy is optimised (in addition to the simple process of storing power) and all power limitations stipulated by law are satisfied at the same time (e.g. 50% KfW or 70% Renewable Energies Act ruling). 



INFO

The smart battery control should only be activated if a limitation has been activated in the inverter. Means that the PV power connected to the inverter must be greater than the power that the inverter is feeding into the grid.

The function should not be activated if the “Storage of excess AC energy from local generation” function has been activated.

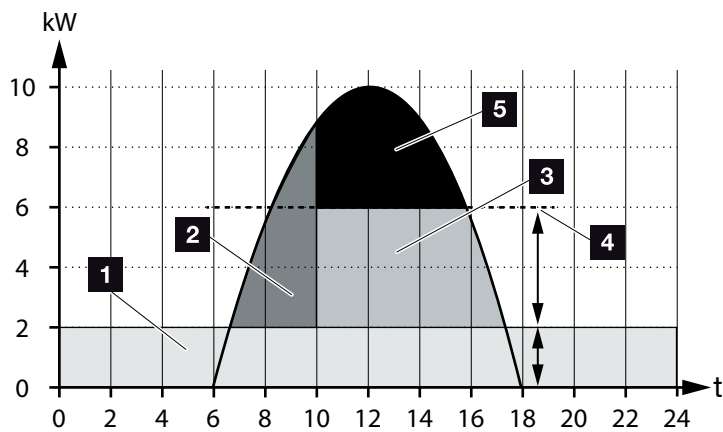

Fig. 56: Control without smart battery control

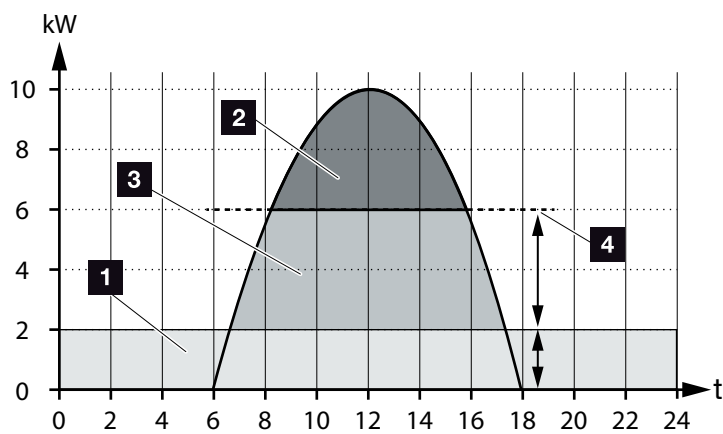



Fig. 57: Control with smart battery control

- 1** Home consumption (own requirement)
- 2** Battery charge
- 3** Feed-in to the public grid
- 4** Limitation of feed-in to approx. 50% according to KfW
- 5** Unused PV energy

 **Fig. 56** Item 4 shows how without smart battery control, especially when there is high solar irradiation, the generated PV energy remains unused e.g. in the case of limiting to approx. 50% because of the KFW ruling.

Using the smart battery control with generation and consumption forecast, the battery is only charged if the excess energy cannot be consumed in the home network or cannot be fed into the public grid. The generated PV energy is therefore used in a sensible manner or stored in the battery.

As a result, the consumer increases his or her self-consumption and degree of self-sufficiency and therefore cuts his or her electricity costs.

7. System monitoring

7.1	The log data	159
7.2	Retrieving, saving and graphically depicting log data	163
7.3	The KOSTAL Solar Portal	165
7.4	Remote service	166

7.1 The log data

The inverter is equipped with a data logger, which regularly records the following data from the system:

- Inverter data
- External energy meter data
- Grid data
- ENS data
- Battery data

You can find out how to retrieve, save and graphically depict log data in the following chapter **Ch. 7.2**

The log data can be used for the following purposes:

- Check operating characteristics of the system
- Determine and analyse errors
- Download and graphically depict yield data

7 Zeit	DC1 U	DC1 I	DC1 P	DC1 T	DC1 S	DC2 U	DC2 I	DC2 P	DC2 T	DC2 S	DC3 U
8 1520946601	0	0	0	0	0	0	0	0	0	0	0
9 1520946901	27	0	1	0	0	0	0	0	0	2	0
10 1520947201	438	0	13	35	0	2	0	0	0	32	0
11 1520947502	443	0	8	34	0	2	0	0	0	32	0
12 1520947804	443	0	22	34	0	2	0	0	0	32	0
13 1520948105	408	0	71	34	0	2	0	0	0	32	0
14 1520948405	445	0	7	34	0	2	0	0	0	32	0
15 1520948705	419	0	63	34	0	2	0	0	0	32	0
16 1520949005	406	0	77	34	0	2	0	0	0	32	0
17 1520949305	449	0	7	34	0	2	0	0	0	32	0
18 1520949602	426	0	66	34	0	2	0	0	0	32	0
19 1520949902	388	1	212	34	0	1	0	0	0	32	0
20 1520950203	398	0	122	34	0	2	0	0	0	32	0
21 1520950505	433	0	9	34	0	2	0	0	0	32	0
22 1520950805	432	0	13	34	0	2	0	0	0	32	0
23 1520951106	448	0	8	34	0	2	0	0	0	32	0
24 1520951407	443	0	12	34	0	2	0	0	0	32	0
25 1520951708	439	0	8	33	0	2	0	0	0	32	0

Fig. 58: Example screen “The log file”

- 1 File header
- 2 Physical variables
- 3 Entries in the log file

Log file: File header

The log file contains a file header with information on the inverter:

Entry	Explanation
Inverter number	Number of the inverter (always 1)
Name	Can be assigned by the user via the browser
Current time	The system time valid at the point in time of file creation in seconds. This makes allocation possible (e.g. 1372170173 Unix time stamp = 25.06.2013 16:22:53) 

Tab. 5: Log file header



INFO

Unix time stamp converter can be found online.

Log file: Physical variables

The file header is followed by the units of the physical variables. The following table explains the abbreviations for the physical variables:

Entry	Explanation
U	Voltage in volts [V]
I	Current strength in milliamps [mA]
P	Power in watts [W]
E	Energy in kilowatt hours [kWh]
F	Frequency in Hertz [Hz]
R	Resistance in kilohms [kOhm]
T	Counting unit in points [digits]
Aln T	Counting unit in points [digits]
Time	Time in seconds [sec] since the inverter was put into operation
TE	Temperature in Celsius [°C]
H	No function [%]

Tab. 6: Physical variables in the log file

Log file: Entries

The units of the physical variables are followed by various entries in the log file.

The following table explains the various entries of the log file and may deviate depending upon the model:

Entry	Explanation
Time	Time in seconds of the time since the inverter went into operation
DCx U	DC voltage: Input voltage of the respective string (x = 1, 2 and 3) in V
DCx I	DC current: Input current of the respective string (x = 1, 2 and 3) in mA
DCx P	DC power: Input power of the respective string (x = 1, 2 and 3) in W
DCx T	DC temperature: Details for service. Temperature of the respective phase (x = 1, 2 and 3) in digital values
DCx S	DC status: Details for service of the respective string (x = 1, 2 and 3)
ACx U	AC voltage: Output voltage of the respective phase (x = 1, 2 and 3) in V
ACx I	AC current: Output current of the respective phase (x = 1, 2 and 3) in mA
ACx P	AC power: Output power of the respective phase (x = 1, 2 and 3) in W
ACx T	AC temperature: Details for service. Temperature of the respective phase (1, 2 and 3) in digital values
AC F	AC frequency: Grid frequency in Hz
FC I	Residual current: Measured residual current in mA
Aln1-4	Is not used
AC S	AC status: Details for service of the operational status of the inverter
ERR	General malfunctions
ENS S	Status of the ENS (device for grid monitoring with assigned switching elements): Status of grid monitoring
ENS Err	Malfunctions of the ENS (device for grid monitoring with assigned switching elements)
SHx P	External current sensor power: Power of the respective phase (x = 1, 2 and 3) in W
SCx P	Self-consumption at the respective phase (x = 1, 2 and 3) in W
HC1 P	not used
HC2 P	Home consumption in W from the PV modules
HC3 P	Home consumption in W from the grid
SOC H	Battery charge status (SOC = State of charge)
BAT Te	Battery temperature
BAT Cy	Number of battery charge cycles
KB S	Internal communication status when switching to AC grid
Total E	Total energy in kWh, which has been generated by the inverter and is being transferred to the AC grid in the house.
OWN E	Self-consumption: Energy in kWh currently being consumed in the house, which is covered by the inverter.

Entry	Explanation
HOME E	Home consumption: Energy in kWh currently being consumed in the house, which is covered by the inverter and from the AC grid.
Iso R	Insulation resistance in kOhm when switching to AC grid
Event	POR event, "power on reset": Renewed start-up of communication after a loss of AC voltage.

Tab. 7: Log data

7.2 Retrieving, saving and graphically depicting log data

There are several variants for retrieving and permanently saving the log data:

- **Variante 1:** Download the log data with a computer and display it
- **Variante 2:** Transfer log data to a solar portal and display it

Variante 1: Download the log data with a computer and display it

1. Call up Log data menu in the Webserver.
 **Ch. 6.1**
 2. Select period (max. 100 days) and confirm with Download.
- ✓ The log data (logdata.csv) can be saved onto a computer and displayed and further processed with any common program for calculating spreadsheets (e.g. Excel).

Variante 2: Transfer log data to a solar portal and display it

With a solar portal it is possible to monitor the PV system and the performance data via the Internet.

A solar portal has the following functions, which, however, may differ depending upon the portal:

- Graphic depiction of performance data
- Worldwide online access to the portal
- Email notification of errors
- Data export (e.g. Excel file)
- Long-term storage of log data

Prerequisites for data transfer to a solar portal:

- ✓ Inverter has an Internet connection
- ✓ Registration on a solar portal (e.g. KOSTAL Solar Portal)
- ✓ Selection of a solar portal
- ✓ Activation of data transfer in the inverter

Activating data transfer to a solar portal via the control panel

1. Select the “Settings/information” menu on the control panel of the inverter.
 2. Confirm with the “ENTER” key.
 3. Use the “UP”, “DOWN” and “ENTER” keys to select the “Solar portal” > “Portal” menu.
 4. Select a solar portal
 5. Press and hold down the “ENTER” key.
 6. Select the “Activate” field and confirm with “ENTER”.
- ✓ Data transfer to the solar portal is now enabled. The name of the solar portal is displayed. The data export to the solar portal is being executed.



INFO

A correctly set-up network connection/Internet connection is a prerequisite for data transfer

It may take as long as 20 minutes following activation (dependent upon the portal) until the data export is visible on the solar portal.

The KOSTAL Solar Portal (www.kostal-solar-portal.com) is preset as a standard solar portal.

7.3 The KOSTAL Solar Portal

The solar portal, manufactured by KOSTAL Solar Electric GmbH, is a free internet platform for monitoring PV systems.

The inverter sends the PV system's yield data and event messages to the solar portal via the internet.

The information is then stored in the solar portal. You can view and call up this information via the internet.

Prerequisites for using the solar portal

- The inverter must have a connection to the internet.
- The inverter must not yet be logged onto the solar portal
- The inverter must not yet be assigned to a plant.

To use the solar portal, follow these two steps:

- Activate data transfer to the solar portal in the inverter. Activation can be performed using the Webserver or the inverter menu .
- Register (free of charge) on the KOSTAL Solar Electric GmbH website to use the KOSTAL Solar Portal.



INFO

If there are several inverters in a plant, data transfer to the solar portal must be set up separately for each inverter.

7.4 Remote service

The inverter includes smart monitoring. Should an event occur during operation, an event code for this is shown in the display.

As the operator of the system, in the event of a service call-out, you can then read out the message and obtain assistance from your installer or service partner.

By updating the software at a later date, the service team is able to directly access the inverter (if you release this option) in order to analyse the error and rectify it directly if possible.

8. External battery control

8.1	External battery control	168
8.2	External battery control via Modbus (TCP)	169
8.3	External battery control via digital inputs	171

8.1 External battery control

With external battery control, an external market operator, e.g. an energy supply company, controls the charge/discharge of the battery by means of an external energy management system.



Here, for example, the energy of the battery can be fed into the public grid as required, e.g. by the energy supply company, or charged from the public grid to stabilise it. The battery energy can of course also be used in your own house grid.

Information about the configuration of the external control can be obtained from the relevant service provider (e.g. energy supply company).

The advantage for the plant owner is that he or she receives remuneration from the external supplier for the energy provided, for example.

The external battery control can be activated and configured in the Webserver in the Service menu under Battery settings.

The following control interfaces are available:

- External battery control via Modbus (TCP)
 **Ch. 8.2**
- External battery control via digital inputs
 **Ch. 8.3**

8.2 External battery control via Modbus (TCP)

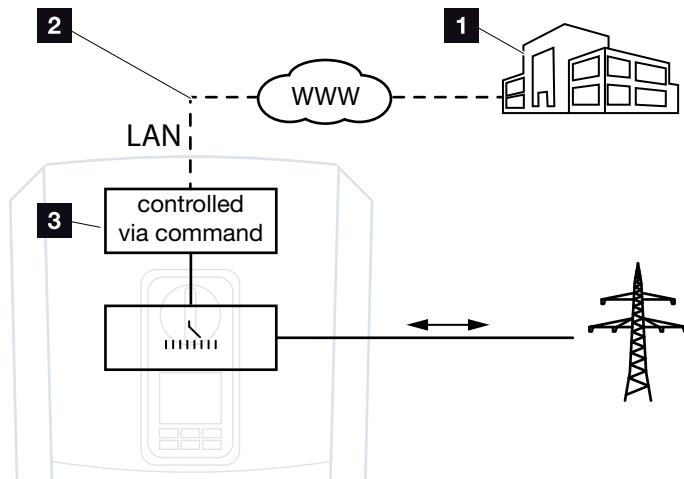

Fig. 59: External battery control via Modbus (TCP)

- 1** External energy management system (e.g. energy supply company)
- 2** Control via Modbus (TCP)
- 3** Control electronics of the battery inverter

If external battery control via Modbus (TCP) is selected, the inverter receives the control signals for charging and discharging the connected battery via Modbus (TCP).

For this purpose, the inverter must be connected to the Internet via Ethernet (LAN).



The internal energy management remains active, but is overridden by the external specifications regarding charging and discharging capacity.

The following commands are possible:

- Charging/discharging of battery via current specified as a percentage or in watts
- Charging/discharging of battery via output specified as a percentage or in watts
- Range specification of a min./max. SOC as a percentage

If external control signals are not received for a long time, the inverter returns to internal battery control. The time for this is set in the Webserver. The specifications of the external provider must be observed.

Activating external battery control via Modbus (TCP)

1. Connect inverter and computer.
 **Ch. 5.1**
2. Launch an Internet browser.
3. Call up the Webserver. To do this, enter the IP address of the inverter in the address line of the Internet browser and confirm with “Return”. 
 - The Webserver page is opened.
4. Log into the Webserver as an installer.
5. Select the “Service menu > Battery settings” menu item.
 - The “Battery settings” page opens.
6. Select the “External via protocol (Modbus TCP)” function under “Battery control”.
7. Click on the “Save” button.
 - ✓ The function is active.



INFO

The IP address can be read on the inverter's display.

8.3 External battery control via digital inputs

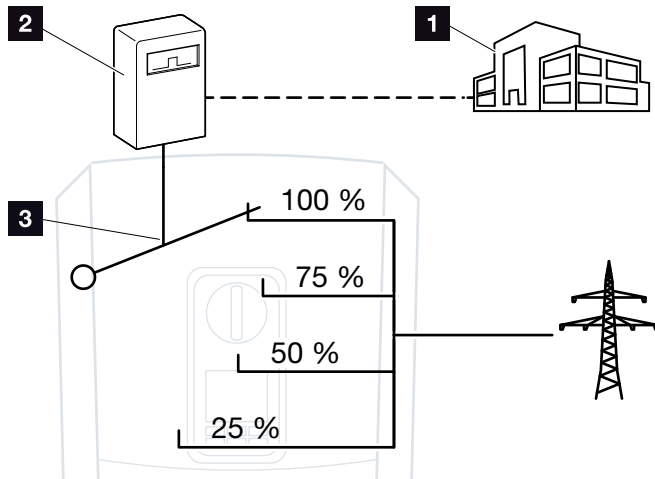

Fig. 60: External battery control via digital inputs

- 1** External energy management system (e.g. energy supply company)
- 2** External control box
- 3** Control electronics of the inverter

If external battery control via digital inputs is selected, the inverter receives the control signals for charging and discharging the connected battery via the digital inputs of the Smart Communication Board (SCB).

It is important that the digital inputs in the Webserver are configured for this purpose.



The internal energy management remains active, but is overridden by the external specifications for charging and discharging capacity.

The following commands are possible:

- Charging/discharging of battery via output specified as a percentage

The specifications of the external provider must be observed.

Activating external battery control via digital inputs

1. Connect inverter and computer.
 **Ch. 5.1**
2. Launch an Internet browser.
3. Call up the Webserver. To do this, enter the IP address of the inverter to which the control box is connected in the address line of the browser and confirm with “Return”. 
- The Webserver page is opened.
4. Log into the Webserver as an installer.
5. Select the “Service menu > Battery settings” menu item.
→ The “Battery settings” page opens.
6. Select the “External via digital I/O” function under “Battery control”.
7. Click on the “Save” button.
✓ The function is active.



INFO

The IP address can be read on the inverter’s display.

Configuration of digital inputs

1. Go to “Service menu > Digital inputs”.
→ The “Digital Inputs” page opens.
2. Select the “External battery management” function under “Operating mode”.
3. Click on the “Save” button.
✓ The function is active.

9. Active power control

9.1	Warum Wirkleistungssteuerung?	174
9.2	Begrenzung der PV-Einspeiseleistung	175
9.3	Wirkleistungssteuerung mit einem Rundsteuerempfänger	176
9.4	Wirkleistungssteuerung über Intelligente Messsysteme	179



9.1 Why active power control?

Some countries or local energy supply companies may stipulate that the full power of the PV system must not be fed into the public grid (e.g. by limiting it to just 70%).

In this case, some energy supply companies therefore offer the owners of PV systems the possibility of have the energy supply company regulate their system using a variable active power control, and thus increasing the feed-in to up to 100% again.

Ask your energy supply company what application rule applies to you.

The planner of a PV system can usually choose between two types of active power control: 

- Limitation of the feed-in capacity to a defined percentage of the PV power at the grid connection point
 **Ch. 9.2**
- Active power control with a ripple control receiver
 **Ch. 9.3**



INFO

When selecting active power control, check to determine which of the two possibilities offers the better energy yield for you.

9.2 Limitation of the PV feed-in capacity

If the energy supply company stipulates a limitation on PV power for your PV system and you are not able or do not want to implement active power control with a ripple control receiver, then the feed-in capacity should be reduced to the value stipulated by the energy supply company (e.g. 70%).

Ask your energy supply company what power limitation applies to you.

The power limitation can be set by going to the inverter menu “Settings/information > Service menu > Energy management > Input or max. feed-in capacity” or using the Webserver by going to “Service menu > Energy management > Limits to [W]”.

9.3 Active power control with a ripple control receiver

The active power of the inverter can be controlled directly by the energy supply company via a ripple control receiver. **i**

With this technology, the generated power can be regulated at four levels: **!**

- 100 %
- 60 %
- 30 %
- 0 %

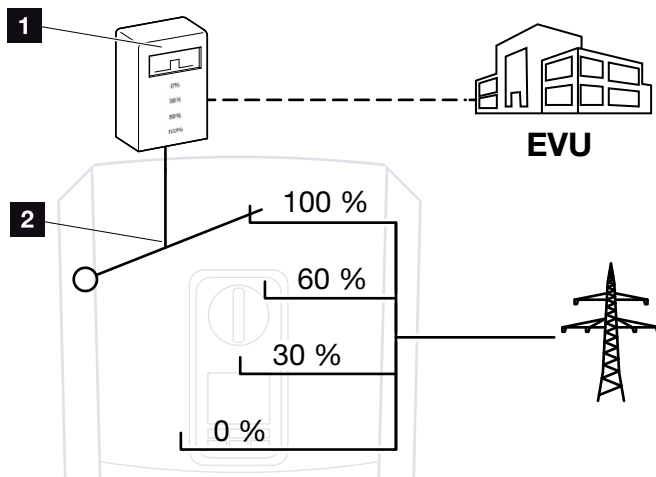

Fig. 61: Active power control with ripple control receiver

- 1** Ripple control receiver
- 2** Control electronics of the inverter

If the active power control is to be controlled by the ripple control receiver on the inverter, please perform the following steps: “Activating active power control” on page 177

If the active power control is to be controlled by another ripple control receiver, please perform the following steps: “Activate receipt of control signals for active power control” on page 178



INFO



The ripple control receiver can be connected directly to the inverter’s Smart Communication Board or is connected to another inverter.



INFO

The four standard specifications for the power limitation can be changed using the Webserver. However, the provisions of the energy supply company must be observed.

Activating active power control

1. Connect inverter and computer.
 **Ch. 5.1**
2. Launch an Internet browser.
3. In the address line of the browser, enter the IP address of the inverter to which the ripple control receiver is connected and confirm with “Return”. 
- The Webserver page is opened.
4. Log into the Webserver as an installer
5. Go to “Service menu > Digital inputs”.
- The “Digital Inputs” page opens.
6. Select the function “Active power control”.
7. If the control signals of this ripple control receiver are to be distributed in the local LAN network (home network) by means of UDP, activate the “Activate distribution of ripple control signals” item. Other inverters can therefore also be controlled using the connected ripple control receiver in the local LAN network.
8. Click on the “Save” button.
- ✓ The active power control is enabled.



INFO

The IP address can be read on the inverter's display.

Activate receipt of control signals for active power control

If a ripple control receiver is already connected to another KOSTAL solar inverter in your home network, you can use the control signals of this ripple control receiver.

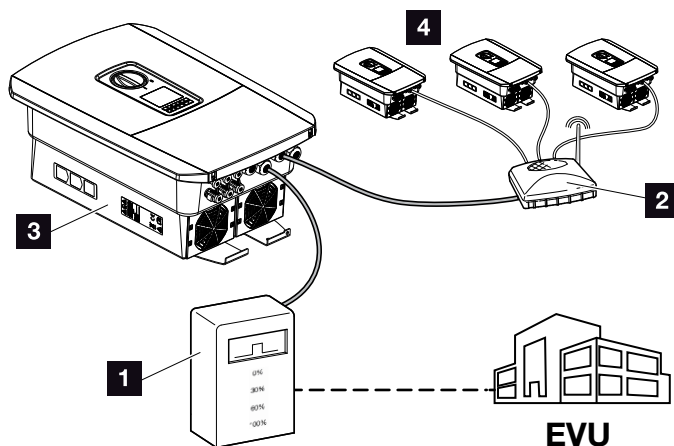

Fig. 62: Inverter with ripple control receiver

- 1** Ripple control receiver
- 2** Router / switch
- 3** Inverter with ripple control receiver, which distributes the control signals in the home network
- 4** Inverter without ripple control receiver, which uses the control signals of another ripple control receiver

Do this by performing the following steps:

1. Log into the Webserver as an installer
2. Go to “Service menu > Energy management”.
- The “Energy management” page opens.
3. Select the “Receipt of broadcast control signals activated” function.
4. Click on the “Save” button.
- ✓ The receipt of broadcast control signals is active.

9.4 Active power control using smart measuring systems

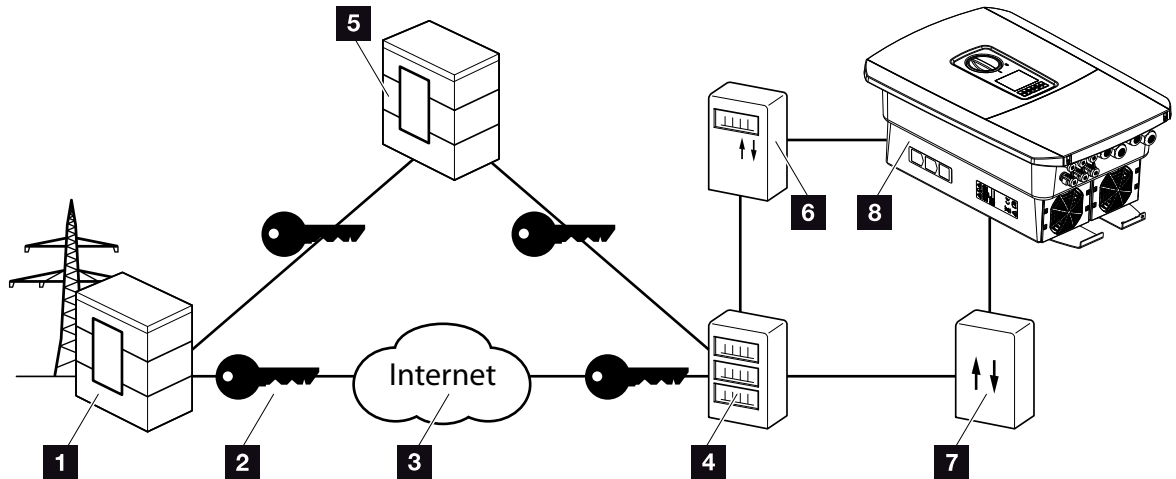

Fig. 63: Connection for smart measuring systems





- 1** Energy supply company
- 2** Encryption
- 3** World Wide Web (Internet)
- 4** Smart meter gateway
- 5** Gateway
- 6** Digital power meter
- 7** Control box
- 8** Inverter

Smart measuring systems have a key role to play in the energy networks of the future.



In this context, a smart measuring system comprises a measuring device (smart meter or digital power meter), which records the measurement data, and a communication unit, the smart meter gateway, which transmits the data to the energy provider via a secure connection. A control box, connected to the inverter, can then be used by the energy supply company to control the inverter and thereby regulate the PV system's feed-in.

These smart measuring systems are already mandatory in some countries. Ask your energy supply company what applies to you.

Connecting control box

1. De-energise the inverter's terminal compartment.
 **Ch. 4.3** 
 2. Fit the control box on the top-hat rail in the control cabinet or power distributor.
 3. Correctly route the communication cable from the inverter to the control cabinet and connect to the control box following the wiring diagram provided by manufacturer (torque: 0.2 Nm). 
 4. Connect communication cable in inverter to terminal for ripple control receiver  **Ch. 3.7**.
 5. Connect control box to the smart meter gateway.
- ✓ The control box is connected.

Connecting digital power meter

1. Fit digital power meter in control cabinet or power distributor.
 2. Correctly route the communication cable from the inverter to the control cabinet and connect to the control box following wiring diagram provided by manufacturer. 
 3. Connect communication cable of digital power meter to terminal for digital energy meter in inverter (torque: 0.2 Nm)  **Ch. 3.6**
 4. Connect digital power meter to the smart meter gateway.
- ✓ Digital power meter is connected.



DANGER

RISK OF DEATH DUE TO ELECTRICAL SHOCK AND DISCHARGE!

De-energise device and secure against being switched on again.

 **Ch. 4.3**



INFO

The communication cable is subject to the following requirements:

- Wire cross-section of
0.34 - 1.5 mm² (rigid)
0.34 - 1.0 mm² (flexible)
- Max. length 30 m
- Length of stripped insulation
4.5-5.5 mm





INFO

The communication cable is subject to the following requirements:

- Wire cross-section of
0.34 - 1.5 mm² (rigid)
0.34 - 1.0 mm² (flexible)
- Max. length 30 m
- Length of stripped insulation
4.5-5.5 mm

Activating active power control in the Webserver

1. Connect inverter and computer.
 **Ch. 5.1**
2. Launch an Internet browser.
3. In the address line of the browser, enter the IP address of the inverter to which the control box is connected and confirm with "Return". 
- The Webserver page is opened.
4. Log into the Webserver as an installer.
5. Go to "Service menu > Digital inputs".
- The "Digital Inputs" page opens.
6. Select the function "Active power control".
7. If the control signals of this ripple control receiver are to be distributed in the local LAN network (home network) by means of UDP, activate the "Activate distribution of ripple control signals" item. Other inverters can therefore also be controlled using the connected ripple control receiver in the local LAN network.
8. Click on the "Save" button.
- ✓ The active power control is enabled.



INFO

The IP address can be read on the inverter's display.

10. Self-consumption control

10.1 Overview of self-consumption control	183
10.2 Connection for self-consumption control	184
10.3 Setting up self-consumption control	186

10.1 Overview of self-consumption control

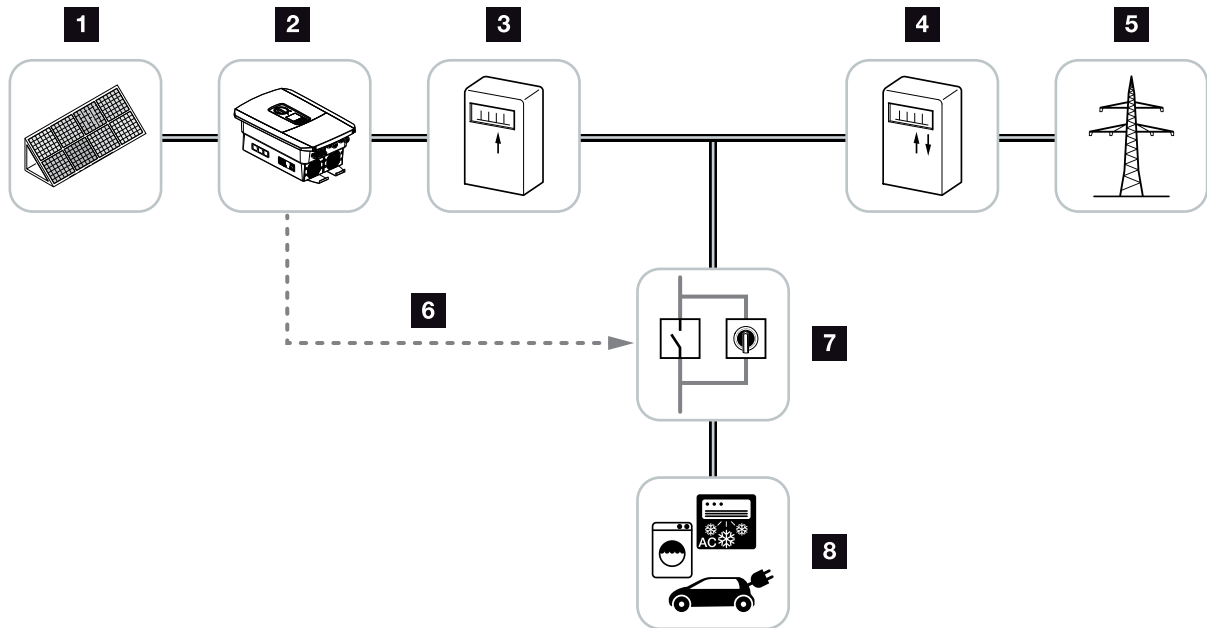

Fig. 64: Configuration of self-consumption control

- 1** Photovoltaic modules
- 2** Inverter
- 3** Production meter
- 4** Feed meter / consumption meter
- 5** Public grid
- 6** Control signal from Smart Communication Board (self-consumption control terminal)
- 7** External load relay with jumper switch
- 8** Consumer device

All inverters are designed in such a way that the generated current can be used for self-consumption.

10.2 Connection for self-consumption control

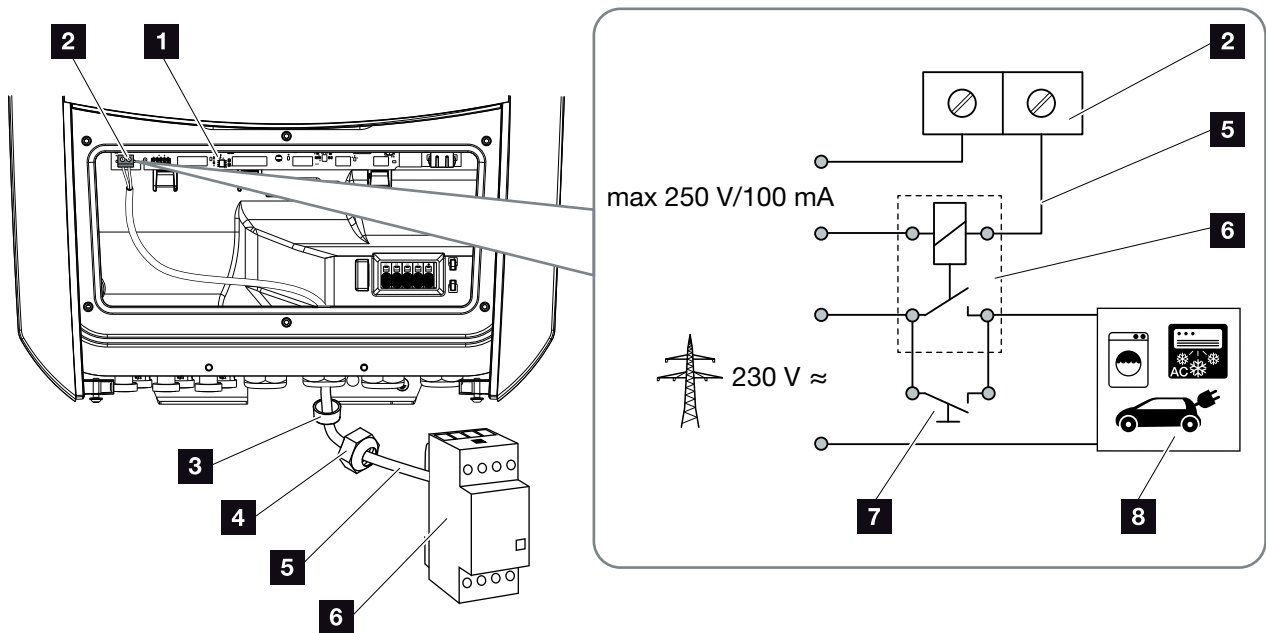







Fig. 65: Electrical connection for self-consumption control

- 1 Smart Communication Board (SCB)
- 2 Terminal for self-consumption control
- 3 Sealing ring
- 4 Union nut
- 5 Control line
- 6 Load relay
- 7 Jumper switch
- 8 Consumer device

For the electrical connection of the self-consumption control, proceed as follows: 

1. De-energise the house grid.  **Ch. 4.3** 
 2. Correctly connect load relay to the terminal for self-consumption control on the Smart Communication Board (torque: 0.5 Nm).
 **Fig. 65 It. 2** 
 3. Properly install and connect the other components of self-consumption control.
- ✓ The electrical connection for self-consumption control has been made. Switch on the inverter.



DAMAGE POSSIBLE

An external load relay must be installed between inverters and devices. No consumers may be connected directly to the inverter!

Loading of switched output:
max. loading: 100 mA
Max. voltage: 250 V (AC or DC)



DANGER

RISK OF DEATH DUE TO ELECTRICAL SHOCK AND DISCHARGE!

De-energise device and secure against being switched on again.

 **Ch. 4.3**



INFO

The control line is subject to the following requirements:

- Wire cross-section of
0.14 - 2.5 mm² (rigid)
0.14 - 1.5 mm² (flexible)
- Max. length 30 m
- Length of stripped insulation
5.5-6.5 mm

10.3 Setting up self-consumption control

Switched output

Function

Self-consumption control

Function 1 (time- and power-related)

Power limit [W]

Limit must be exceeded for [min]

Run time [min]

Frequency of activation [number/day]

Function 2 (power-related)

Activation limit [W]

Deactivation limit [W]

Other options

Leave switched output activated in event of power loss or fault



Permitted period of time for power loss or fault [min]

Fig. 66: Self-consumption control functions for Webserver

Several functions are available here to enable the user to control self-consumption. You will find a more accurate explanation on the following pages.

When a battery is connected, “dynamic self-consumption control” should always be selected.

Activating self-consumption control

1. Calling up Webserver
 2. Go to “Service menu > Switched output”
 3. In the “Function” field, select the option “Self-consumption control” or “Dynamic self-consumption control”. 
 4. Choose function 1 or function 2. 
 5. Enter values for the function.
 6. Activate the optional value for “Leave switched output activated in event of power loss or fault” using check box and enter time period. 
 7. Click on “Save”.
- ✓ The self-consumption control function is active.



INFO

When selecting “Dynamic self-consumption control”, the measured home consumption determined using the digital energy meter is automatically added to the set value and taken into consideration.



INFO

You can find more detailed explanations regarding the selection of function 1 or 2 in the course of the chapter.



INFO

The command “Leave switched output activated in event of power loss or fault” can be used for function 1 and 2.

Self-consumption control function 1

Control of self-consumption by time

When a certain rating **P1** has been generated for a certain period of time **T1**, the inverter switches to self-consumption. **i**

The inverter remains in self-consumption mode for the entire run time **T2**. Following the run time **T2**, the inverter ends self-consumption.

This is the end of the interval. This interval can be repeated several times with the “Activation” option.



INFO

If there is a battery connected to the inverter, when charging the battery, this energy is drawn from the generated PV energy. When this happens, instances may arise where the threshold value P1 is not reached despite sufficient PV energy.

When selecting “Dynamic self-consumption control”, the measured home consumption P_c (e.g. 700W in this case) is taken into consideration and automatically added to the set power limit P1. In our example, this means that the contact only closes at 1700W.

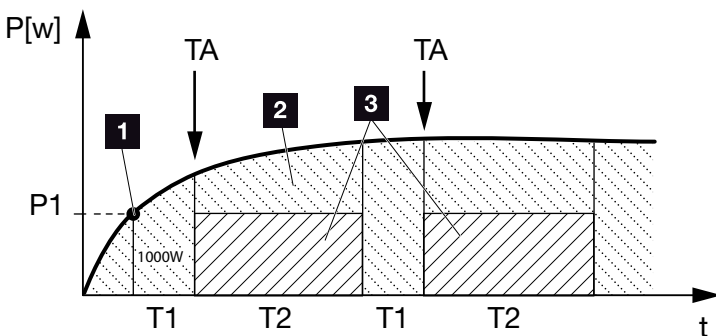

Fig. 67: Self-consumption graph (Function 1)

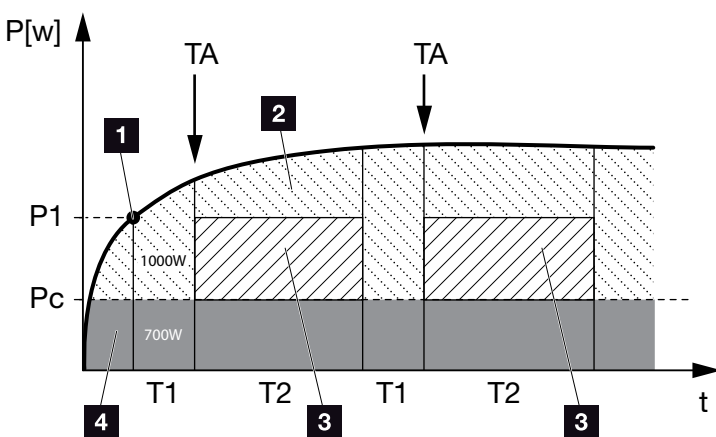

Fig. 68: Dynamic self-consumption graph (Function 1) Power limit

- 1** Power limit
- 2** Feed-in to the public grid
- 3** Self-consumption via self-consumption contact
- 4** Self-consumption in the home network

P1: Power limit

This is the minimum power (in watts) that must be produced (e.g. 1000 W) before the consumer is switched on. You can enter any value from 1 watt to 999 000 watts.

T1: Period of stable exceeding of the output limit (P1)

The inverter must exceed the set “power limit” for this period of time (in minutes) before the consumer is switched on. You can enter any value between 1 and 720 minutes (= 12 hours).

T2: Run time

The connected consumer is switched on for this period (in minutes) when both of the above conditions have been met. You can enter any value between 1 and 1440 minutes (= 24 hours). The run time ends when the inverter shuts off. The run time is ended and not continued again if the inverter has not produced any current for three hours.

TA: Activation

Dashed area: Self-consumption at self-consumption terminal active

The number **TA** (number/day) indicates how often self-consumption is activated each day.

Pc: Level of self-consumption

Grey area: Self-consumption in home network

This is taken into account in the dynamic self-consumption control. This means the self-consumption contact is only closed when power limit P1 less the self-consumption reaches the set value.

Self-consumption control function 2

Control of self-consumption by rating

When a certain rating **P1** has been generated (e.g. 1000 W), the inverter switches to self-consumption. **i**

When the rating **P2** is not achieved (e.g. 700 W), the inverter ends self-consumption and resumes feeding current into the grid. **i**

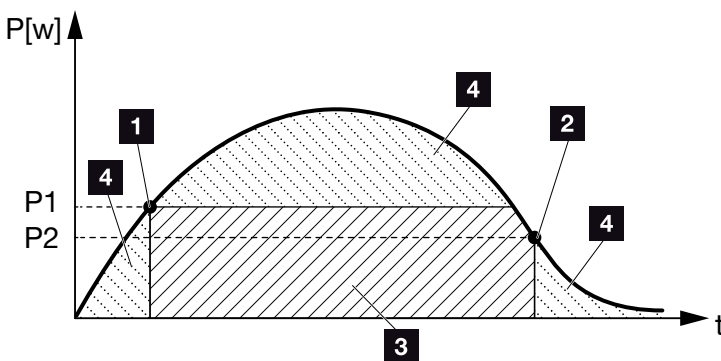

Fig. 69: Self-consumption graph (Function 2)

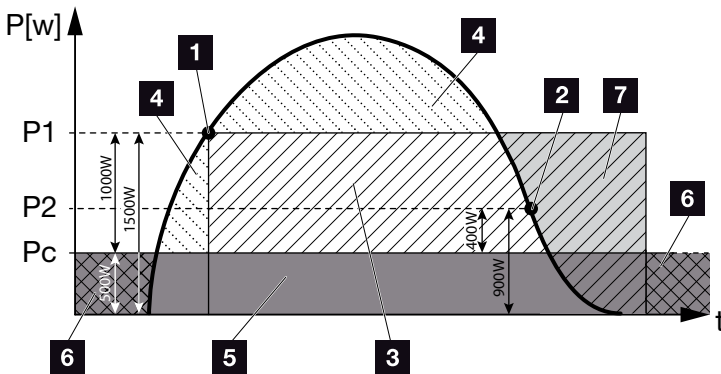

Fig. 70: Dynamic self-consumption graph (Function 2)

- 1** Activation limit
- 2** Deactivation limit
- 3** Self-consumption via self-consumption contact
- 4** Feed-in to the public grid
- 5** Self-consumption in the home network
- 6** Purchased from the public grid
- 7** Battery use possible with battery connected up to DoD



INFO

If there is a battery connected to the inverter, when charging the battery, this energy is drawn from the generated PV energy. When this happens, instances may arise where the threshold value P1 is not reached despite sufficient PV energy.



INFO

When selecting “Dynamic self-consumption control”, the measured home consumption P_c , e.g. 500 W, is taken into consideration and automatically added to the set power limit P1, e.g. 1000 W, and P2, e.g. 400 W. This means that the contact does not close until 1500 W and opens again at 900 W.

P1: Activation limit

This is the minimum power (in watts) that must be produced before the consumer is activated.

You can enter any value from 1 watt to 999 000 watts.

P2: Deactivation limit

The consumer is switched off when the power generated falls below this value.

Pc: Level of self-consumption

Grey area: Self-consumption in home network

This is taken into account in the dynamic self-consumption control. This means the self-consumption contact is only closed when power limit P1 less the self-consumption reaches the set value.

Delay in drop in output/fault

Delay time for switching off self-consumption

With this function, self-consumption is only discontinued after the set delay time **T1**. In the event of power loss, fault (**Tx**) and the failure to achieve the shutdown limit, the consumer remains switched on for the set time (**T1**).

If the fault period or the period of power loss is shorter than the set delay time, self-consumption remains activated.

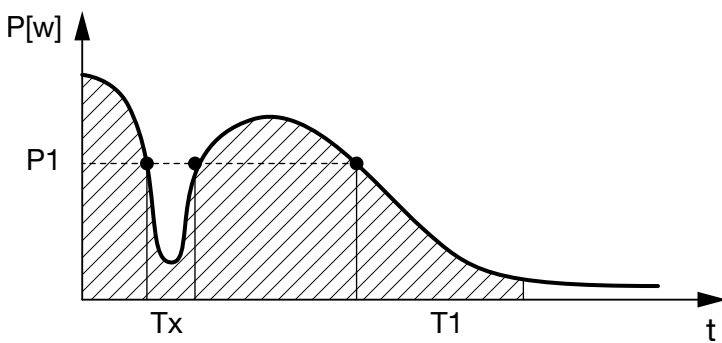

Fig. 71: Brief delay in drop in output/fault

P1: Power limit

T1: Delay time in the event of power loss/fault

Tx: Fault, power loss or failure of the inverter

Dashed area: Self-consumption active



11. Maintenance

11.1 Maintenance and cleaning	194
11.2 Housing cleaning	195
11.3 Fan cleaning	196
11.4 Updating software	200
11.5 Event codes	202

11.1 Maintenance and cleaning

Once correctly installed, the inverter runs virtually maintenance-free.

The following maintenance tasks are to be carried out for the inverter:

Activity	Interval
Check cable connections and plugs	1x annually
Clean fans  Ch. 11.3 	1x annually

Tab. 8: Maintenance list

If no maintenance work is carried out, this results in an exclusion of the warranty (see 'Exclusion of warranty' in our Service and warranty conditions).



DAMAGE POSSIBLE

Dirty or blocked fans mean that the inverter is not adequately cooled. Insufficient cooling of the inverter may result in output reduction or the failure of the system.

Always mount inverters in such a way that falling parts cannot fall into the inverter through the ventilation grille.

11.2 Housing cleaning

The housing may only be wiped down with a damp cloth. Abrasive cleaners are not permitted.

11.3 Fan cleaning

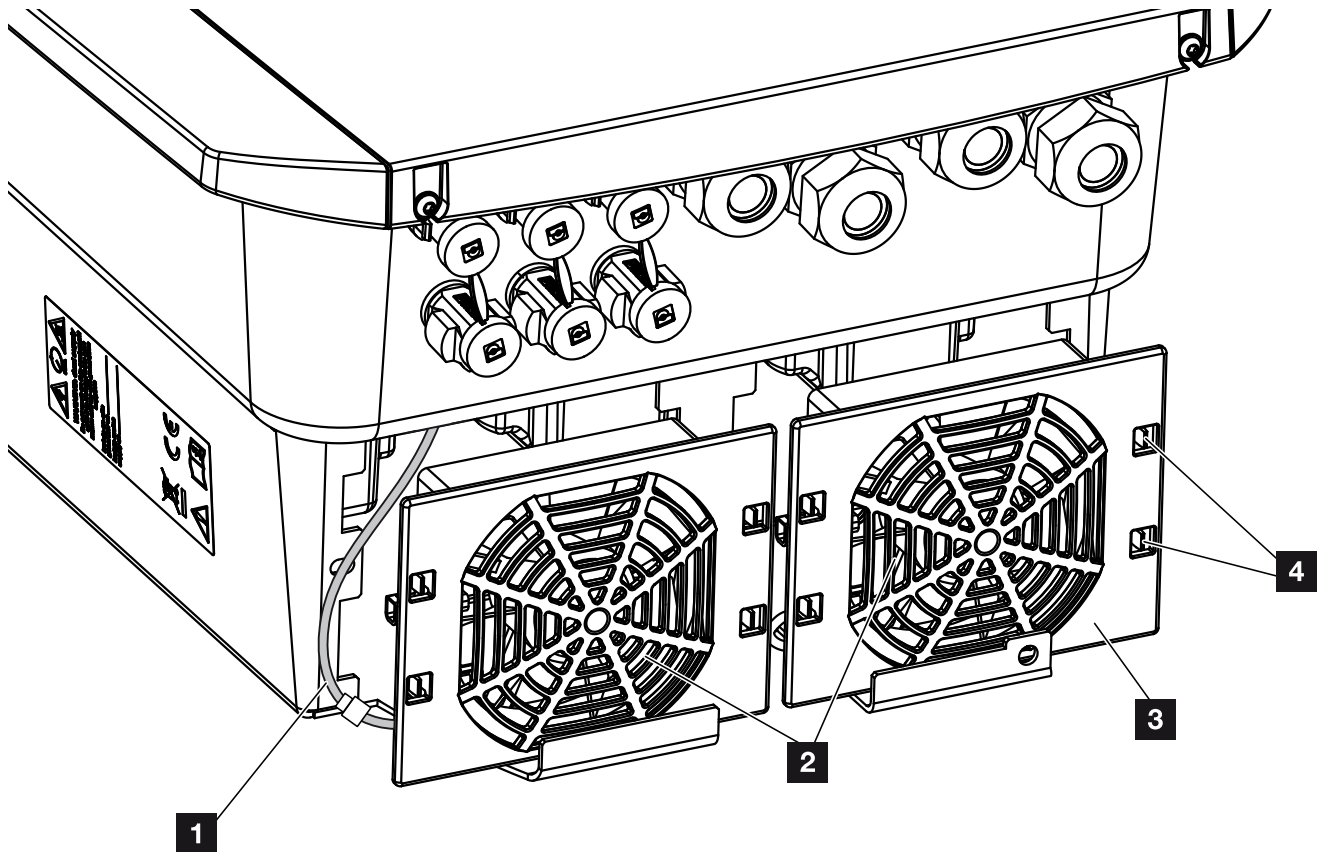



Fig. 72: Fan disassembly overview

- 1** Fan cable
- 2** Fan
- 3** Fan grill
- 4** Fastening straps

Procedure

The fan may only be removed and cleaned if the inverter is switched off. Otherwise, the fan may start up.

1. Turn the DC switch on the inverter to OFF.  **Fig. 12**
2. Dismantle the fan. To do this, place a screwdriver at the edge of the fan grill and apply a little pressure to the fan grill.  **Fig. 73**

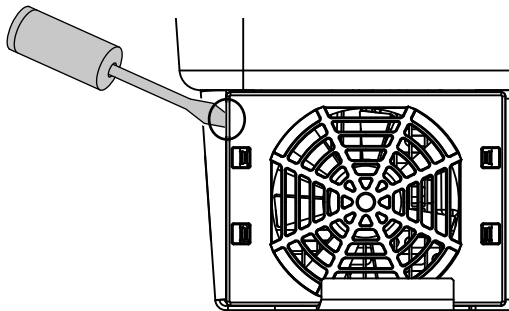



Fig. 73: Loosen fan grill

3. Press the fastening straps toward the centre of the fan with a second screwdriver.
Pull the fan unit slightly forward.  **Fig. 74**

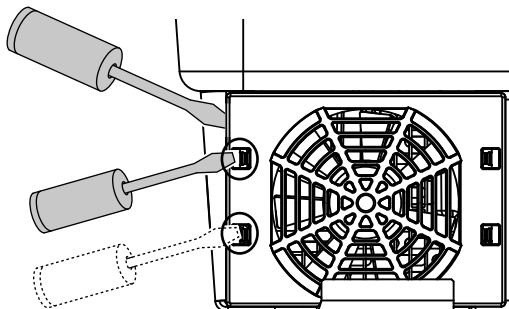



Fig. 74: Loosen fastening straps

4. Completely remove the fan unit from the housing.
To do this, disconnect the plug of the fan cable.

 **Fig. 75** 

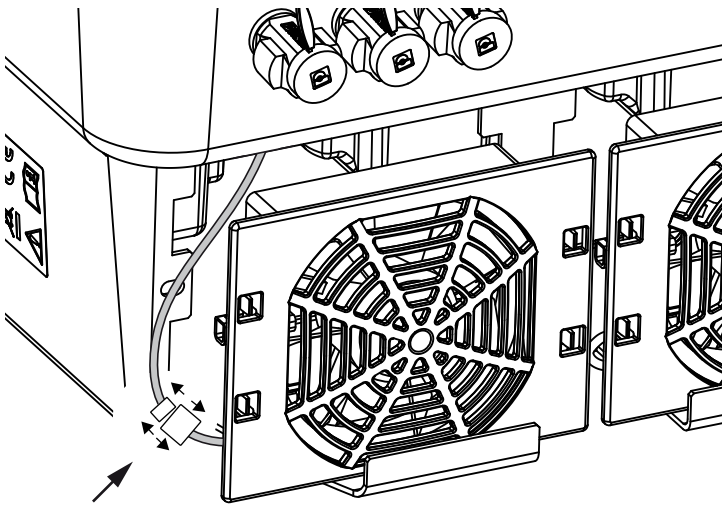

Fig. 75: Pull out fan cable

5. The fan can also be pulled off the fan grill. To do this, press the fastening straps slightly outward and pull off the fan.

 **Fig. 76**

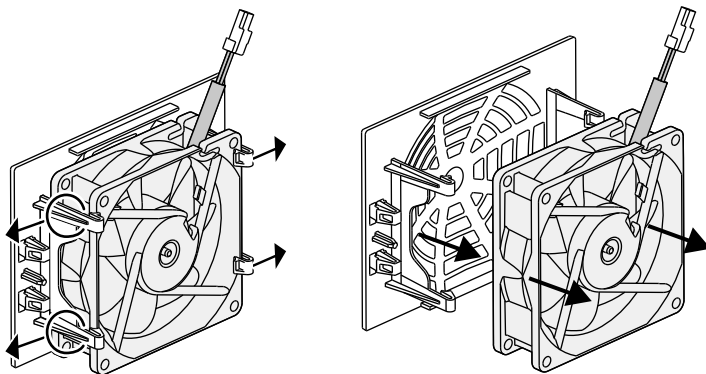

Fig. 76: Disassembly of the fan grill

6. Clean fan and housing opening with a soft brush.



**IMPORTANT
INFORMATION**

Note the cable guide inside the housing.

When installing the fan, the fan cable must be relaid in exactly the same way.

7. Note the following when installing the fan: **!**
- the fan must be correctly installed in the fan frame (air flow direction). **↗ Fig. 77**
 - the cable must point into the housing.
 - the cable of the fan must not be jammed.

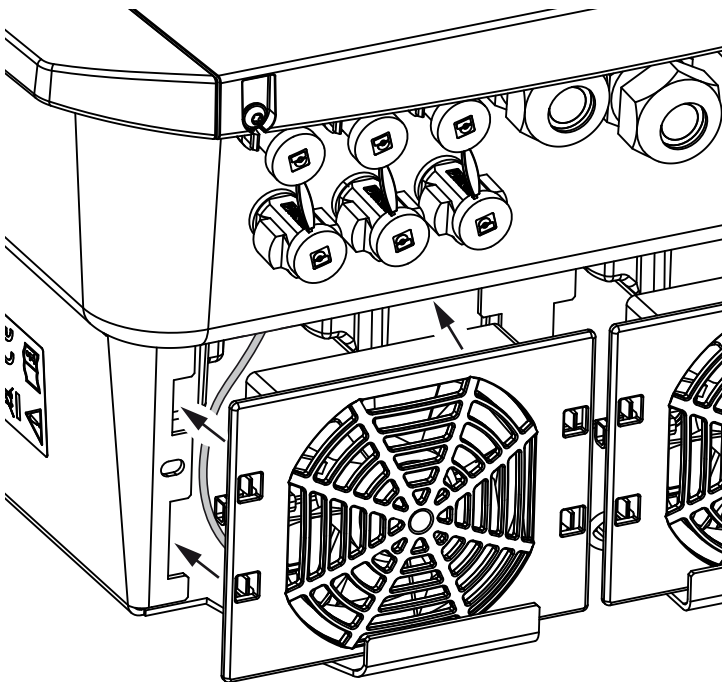

Fig. 77: Fan installation

8. Reconnect the fan cable and insert the fan into the housing. When switching on for the first time, check whether the air from the fan is drawn inwards.
9. Start up the inverter **↗ Ch. 4.1**



**IMPORTANT
INFORMATION**

When installing the fan ensure that the cables are laid so that they do not run into the fan. If this is not done, the fan may fail or noise may result.

11.4 Updating software



When the manufacturer updates the software, the user has the option of updating his or her version too. In the process, the software and the user interface (UI) of the Smart Communication Board are brought completely up-to-date. If an update is available, you will find this on the manufacturer's website, in the download area for the product.

Procedure

- Updating using Webserverr

Updating using Webserver

Updating the inverter using the Webserver is a very simple process. To do this, simply select the update file (*.swu) on the computer via the Webserver and start the installation.

1. Download the update for the inverter from the manufacturer's website to your computer.
 2. Call up the Webserver  **Ch. 6.2**
 3. Go to "Update".
 4. Click on the "Select file" button and select the update file (*.swu) on the computer or drag the update file into the field.
 5. Start the installation using "Run".
- The inverter recognises the update file and starts the installation.
6. If you want to install the update, confirm the question with "OK".
- The update is installed on the inverter. Once the update has been installed, the inverter is restarted. The update may take up to 10 minutes. Following the update, the successful installation is shown on the installer's display. 
7. Once the update has been successfully installed, the current software version can be queried on the inverter or Webserver.
This is done in the inverter's menu by going to: Settings/information > Device information or in the Webserver by going to Info.
- ✓ The update has been installed.



INFO

Following a successful update, the inverter automatically returns to feed-in mode.

11.5 Event codes

There is no need to take action when an event occurs occasionally or only briefly and the device resumes operation. When an event lasts for long periods or recurs frequently, the cause must be determined and rectified.

A list of the current event codes and measures can be found in the document “**Ereignisliste / Event list**”, which can be found in the download area for your product.

12. Technical data

12.1 Technical data	204
12.2 Block diagram	209

12.1 Technical data

Subject to technical changes. Errors excepted.

You can find current information at www.kostal-solar-electric.com.

Inverter	Unit	3.0	4.2	5.5	7.0	8.5	10
Input side (DC)							
Inverter type		PLENTICORE plus					
Max. PV power ($\cos \varphi = 1$)	kWp	4.5	6.3	8.25	10.5	12.75	15
Max. PV power per DC input	kWp	6.5					
Nominal DC power	kW	3.09	4.33	5.67	7.22	8.76	10.31
Rated input voltage ($U_{DC,r}$)	V	570					
Start input voltage ($U_{DC,start}$)	V	150					
Input voltage range ($U_{DC,min} - U_{DC,max}$)	V	120...1000					
MPP range at rated output in single-tracker operation ($U_{MPP,min}$)	V	240...720 ⁵	350...720 ⁵	450...720 ⁵	-	-	-
MPP range at rated output in two-tracker operation ($U_{MPP,min}$)	V	180...720 ⁵	180...720 ⁵	225...720 ⁵	290...720 ⁵	345...720 ⁵	405...720 ⁵
MPP range at rated output in three-tracker operation ($U_{MPP,min}$)	V	140...720 ⁵	140...720 ⁵	160...720 ⁵	195...720 ⁵	230...720 ⁵	275...720 ⁵
MPP working voltage range ($U_{MPP,workmin} - U_{MPP,workmax}$)	V	120...720 ⁵					
Max. working voltage ($U_{DC,workmax}$)	V	900					
Max. input current ($I_{DC,max}$) per DC input	A	13					
Max. PV short-circuit current ($I_{SC,PV}$) per DC input	A	16.25					
Number of DC inputs		3					
Number of DC inputs for battery (optional)		1					
Number of independent MPP trackers		3					
Input side (DC 3 – battery input)							
Operating voltage range for battery input ($U_{DC,workbatmin} - U_{DC,workbatmax}$)	V	120 ⁵ ...650					
Max. charging current/discharging current at battery input	A	13/13					

Inverter	Unit	3.0	4.2	5.5	7.0	8.5	10
Output side							
Rated output, $\cos \varphi = 1$ ($P_{AC,r}$)	kW	3.0	4.2	5.5	7.0	8.5	10
Max. output apparent power, $\cos \varphi_{r,adj}$	kVA	3.0	4.2	5.5	7.0	8.5	10
Min. output voltage (U_{ACmin})	V	320					
Max. output voltage (U_{ACmax})	V	460					
Rated output current	A	4.33	6.06	7.94	10.10	12.27	14.43
Max. output current (I_{ACmax})	A	4.81	6.74	8.82	11.23	13.63	16.04
Switch-on current (I_{Inrush})	A	2.46	2.46	2.46	6.72	6.72	6.72
Short-circuit current (peak / RMS)	A	6.8/4.8	9.5/6.7	12.5/8.8	15.9/11.2	19.3/13.6	22.8/16.1
Number of feed-in phases		3					
Grid connection		3N~, AC, 400V					
Rated frequency (fr)	Hz	50					
Grid frequency ($f_{min} - f_{max}$)	Hz	47/52.5					
Setting range of the power factor $\cos \varphi_{AC,r}$		0.8...1...0.8					
Power factor for rated power ($\cos \varphi_{AC,r}$)		1					
Max. THD	%	3					
Device properties							
Standby	W	7.9					
Standby incl. 24h home-consumption measurement	W	7.9					
Efficiency							
Max. efficiency	%	97.1	97.1	97.1	97.2	97.2	97.2
European efficiency	%	95.3	95.5	96.2	96.5	96.5	96.5
MPP adjustment efficiency	%	99.9					

Inverter	Unit	3.0	4.2	5.5	7.0	8.5	10
System data							
Topology: Without galvanic isolation – transformerless					✓		
Protection class in accordance with IEC 60529					IP 65		
Protective class in accordance with IEC 62103					I		
Overvoltage category according to IEC 60664-1 input side (PV generator) ¹					II		
Overvoltage category according to IEC 60664-1 output side (grid connection) ²					III		
Degree of contamination ³					4		
Environmental category (outdoor installation)					✓		
Environmental category (indoor installation)					✓		
UV resistance					✓		
Cable diameter of AC connection cable (min-max)					8...17		
Cable cross-section of AC connection cable (min-max)	mm ²		1.5...6			2.5...6	4...6
Cable cross-section of PV connection cable (min-max)	mm ²				2.5...6		
Cable cross-section of battery connection cable (min-max)	mm ²				4...6		
Torque of screws in terminal compartment	Nm				2		
Torque of screws in cover	Nm				1.5		
Max. fusing on output side according to IEC 60898-1					B16/C16		B25/ C25
Compatibility with external residual current protection devices (as of FW 01.14)					Type A RCD		

Inverter	Unit	3.0	4.2	5.5	7.0	8.5	10
Internal operator protection according to EN 62109-2 (compatible with type A RCB as of FW 01.14)					✓		
Independent disconnection device according to VDE V 0126-1-1 ⁴					✓		
Electronic DC disconnection device integrated					✓		
Reverse polarity protection, DC-side					✓		
Height/width/depth	mm (inch)	563 / 405 / 233 (22.17 / 15.94 / 9.17)					
Weight	kg (lb)	19.6 (43.21)			21.6 (46.62)		
Cooling principle – regulated fans					✓		
Max. air throughput	m ³ /h	184					
Noise emission (typical) ⁶	dB(A)	39					
Ambient temperature	°C (°F)	-20...60 (-4...140)					
Max. operating altitude above sea level	m (ft)	2000 (6562)					
Relative humidity	%	4...100					
Connection technology, DC side		SUNCLIX plug					
Connection technology, AC side		Spring-type terminal strip					
Interfaces							
Ethernet LAN (RJ45)		1					
RS485 / CAN (for battery communication)		1					
Connection of energy meter for collecting energy data (Modbus RTU)		1					
Digital inputs (e.g. for digital ripple control receiver or for external battery management)		4					
Potential-free contact for self-consumption control		1					

Inverter	Unit	3.0	4.2	5.5	7.0	8.5	10
USB 2.0					1		
Websserver (user interface)					✓		
Warranty							
Warranty following registration with the KOSTAL Solar online shop (*without registering)	Years				5 (2*)		
Warranty extension optional	Years				5/10/15		
Directives / Certification							
CE, GS, CEI 0-21, CEI10/11, EN 62109-1, EN 62109-2, EN 60529, EN 50438*, EN 50549-1*, ENA/EEA, G98, G99, IFS2018, IEC 61727, IEC 62116, RD 1699, RFG, TF3.3.1, TOR producer, UNE 206006 IN, UNE 206007-1 IN, UTE C15-712-1, VDE 0126-1-1, VDE-AR-N 4105, VJV2018							
(* does not apply to all national annexes)							

¹ Overvoltage category II (DC input): The device is suitable for connection to PV strings. Long feed cables out of doors or a lightning protection system in the vicinity of the PV system, may make lightning protection or surge protection equipment necessary.

² Overvoltage category III (AC output): The device is suitable for permanent connection in the grid distribution behind the meter and the line protection fuse. When the connection line travels outdoors over long distances, overvoltage protection devices may be necessary.

³ Contamination degree 4: Contamination results in continuous conductivity, e.g. due to conductive dust, rain or snow; indoors or outdoors.

⁴ Automatic disconnection device to VDE V 0126-1-1, for Austria: The inverter is equipped "With automatic disconnection device in accordance with ÖVE/ÖNORM E 8001-4-712".

⁵ MPP range 120V...180V (with limited current of 9.5-13A) to 680V...720V (with limited current of 11A). A detailed layout should be produced using the KOSTAL Solar Plan user software.

⁶ Measured under rated output at an ambient temperature of 23 °C. In the case of an unfavourable string connection or higher ambient temperature, the noise emission may be up to 48 dB(A).

12.2 Block diagram

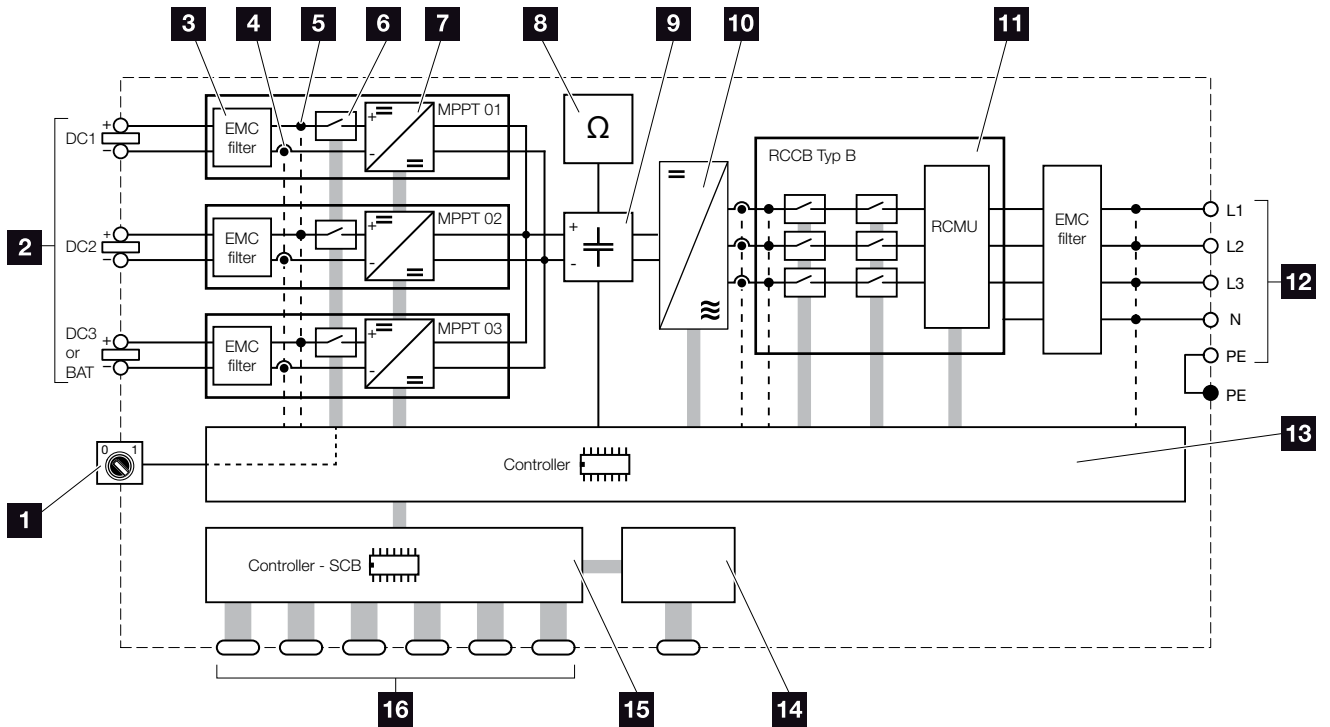

Fig. 78: Block diagram

- 1** DC switch
- 2** PV strings
- 3** Electromagnetic compatibility (EMC) filter
- 4** Current measuring point
- 5** Voltage measuring point
- 6** Electronic DC disconnection device
- 7** DC regulator
- 8** Insulation monitoring
- 9** Intermediate circuit
- 10** Inverter bridge
- 11** Grid monitoring and shut-down
- 12** 3-phase AC output
- 13** System control with MPP trackers
- 14** Display
- 15** Smart Communication Board (SCB)
- 16** Interfaces (e.g. Ethernet, USB, energy meter)

13. Accessories

13.1 KOSTAL Solar Portal	211
13.2 KOSTAL Solar App	212
13.3 PIKO M2M Service	213
13.4 Activating battery connection	214

13.1 KOSTAL Solar Portal

The KOSTAL Solar Portal allows operation of the inverters to be monitored via the Internet. You can register for the KOSTAL Solar Portal for no charge on our website.

The portal code for the KOSTAL Solar Portal (www.kostal-solar-portal.com) is P3421.

Additional information about this product is available on our website www.kostal-solar-electric.com under **Products > Tools and software > Monitoring**.

13.2 KOSTAL Solar App

The free KOSTAL Solar App provides you with a way of professionally monitoring your photovoltaic system. You can use the KOSTAL Solar App to simply and easily access all functions on your smartphone or tablet at any time.

To set up and use the app, you will need access to the KOSTAL Solar Portal and to have an inverter set up there. The same access data used for the KOSTAL Solar Portal is required to log into the app.

You can use the KOSTAL Solar App to easily monitor your photovoltaic system and to display relevant system data both when you are out and about and at home. It allows you to access the consumption and generation data over various time periods, such as day, week, month and year, and to access the historical data of your photovoltaic system. So you are always up-to-date with the KOSTAL Solar App.

Download the free KOSTAL Solar App today and benefit from new and advanced functionalities.

Additional information about this product is available on our website www.kostal-solar-electric.com under **Products > Tools and software > Monitoring**.

13.3 PIKO M2M Service

The PIKO M2M Service allows KOSTAL customers to monitor a PV system using a mobile link to the KOSTAL Solar Portal. for continuous system monitoring.

A secure and encrypted VPN connection, which only allows communication between inverters and the KOSTAL Solar Portal, protects the user against misuse and excessive costs.

The 5-year package price involves no monthly costs, reducing administration and assuring smooth monitoring for a period of at least five years. Two different packages are available depending on the size of the system.

Additional information about this product is available on our website www.kostal-solar-electric.com under **Products > Tools and software > Monitoring.**

13.4 Activating battery connection

For the PLENTICORE plus, there is an option of releasing the third PV input (DC3) as a connection for battery storage. To do this, you can purchase a “Battery activation code” from our KOSTAL Solar online shop and enter this in the inverter. Then, you can use the third PV input to connect a battery.

You can find more information about this product on our website www.kostal-solar-electric.com.

You will find a list of approved batteries in the download area for the PLENTICORE plus.

Should you have any further questions, please contact our sales team or your service partner.

- Purchase a battery activation code from the KOSTAL Solar online shop
- Enter battery activation code in inverter or via the Webserver
- Connect battery to third PV input (DC3) on inverter
 **Ch. 3.10**
- Configure the battery settings in the Webserver (e.g. battery use strategy, battery charge, etc.)

14. Appendix

14.1 Type plate	216
14.2 Warranty and service	217
14.3 Handover to the operator	218
14.4 Decommissioning and disposal	219

14.1 Type plate

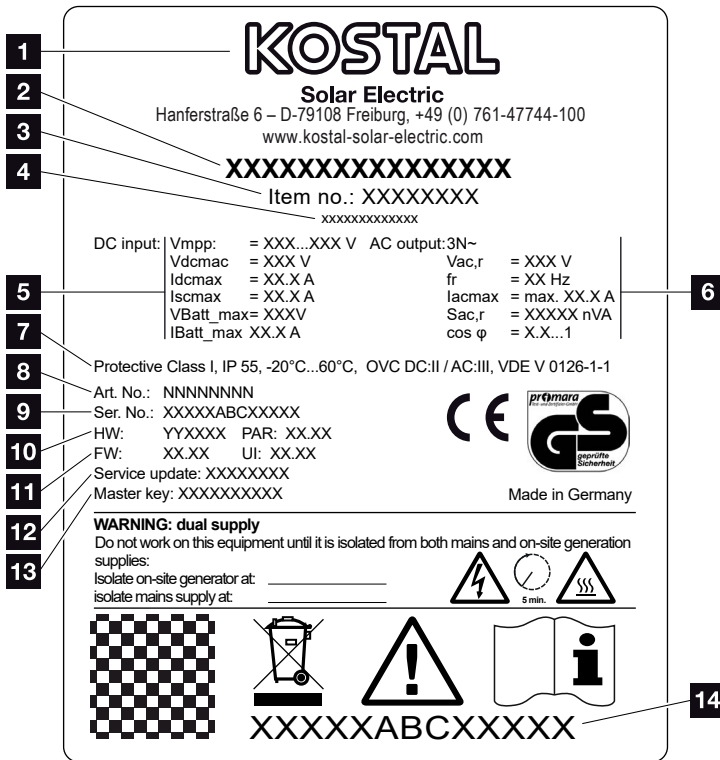

Fig. 79: Type plate

The type plate is located on the inverter. You will find the device type and the most important technical data listed on the type plate.

- 1** Name and address of manufacturer
- 2** Device type
- 3** Article number
- 4** Additional designation (e.g. service device)
- 5** Details of the DC input:
 - MPP control range
 - max. DC input voltage
 - max. DC input current
 - max. DC short-circuit current
 - max. DC battery input voltage
 - max. DC battery input current
- 6** Details of the AC output:
 - number of feed-in phases
 - output voltage (nominal)
 - grid frequency
 - max. AC output current
 - max. AC power
 - setting range of power factor
- 7** Protective class in accordance with IEC 62103, protection class, ambient temperature range, overvoltage category, requirements with which the integrated grid monitoring complies
- 8** Internal article number
- 9** Serial number
- 10** Version number of hardware, version number of parameter set
- 11** Version number of the firmware, version number of the user interface of the device
- 12** Date of last update (only for service devices)
- 13** Master key password for installer's Webserver login
- 14** Removable warranty label

14.2 Warranty and service

The warranty period for the inverter is 2 years from the date of purchase. If you register the inverter with the KOSTAL Solar online shop within the first 6 months from the date of purchase, you can extend this free of charge to our KOSTAL 5-year Smart Warranty.

You can find more information about the service and warranty conditions for your inverter in the download area for the product on our website at www.kostal-solar-electric.com.

For service information and a possible subsequent shipment of parts, we require your device type and the serial number. You will find this information on the type plate on the exterior of the housing.

If parts are required, use only original replacement parts.

If you have any technical questions, please call our service hotline:

- Germany and other countries¹
+49 (0)761 477 44 - 222
- Switzerland
+41 32 5800 225
- France, Belgium, Luxembourg
+33 16138 4117
- Greece
+30 2310 477 555
- Italy
+39 011 97 82 420
- Spain, Portugal²
+34 961 824 927
- Turkey³
+90 212 803 06 26

¹ Language: German, English

² Language: Spanish, English

³ Language: English, Turkish



14.3 Handover to the operator

Following successful installation and commissioning, all documents are to be handed over to the operator. The operator must be made aware of the following points:

- Position and function of the DC switch
- Position and function of the AC line circuit breaker
- Safety when handling the device
- Appropriate procedure when checking and servicing the unit
- Meaning of the LEDs and the display messages
- Contact person in the event of a fault
- The provision of system and inspection documentation in accordance with DIN EN 62446 (VDE 0126-23) (optional).

14.4 Decommissioning and disposal

To disassemble the inverter, proceed as follows:

1. De-energise inverter on AC and DC side.  **Ch. 4.3**

2. Open the inverter cover.
3. Loosen terminals and cable glands.
4. Remove all DC and AC lines and communication cables.
5. Close the inverter cover.
6. Loosen the screw underneath the inverter.
7. Loosen screws on top of inverter.
8. Lift the inverter off the wall.

Proper disposal

Electronic equipment labelled with a dustbin with a line through it may not be disposed of with household waste. This equipment can be handed in to waste collection points free of charge.



Find out about the local requirements for the separate collection of electrical and electronic equipment in your country.



DANGER

RISK OF DEATH DUE TO ELECTRICAL SHOCK AND DISCHARGE!

De-energise device and secure against being switched on again.

 Ch. 4.3

Index

A

Accessories	210
Active power control	174, 177, 181

B

Battery configuration	135
Battery use strategy	140, 153
Block diagram	209

C

Cable	207
Calling up Webserver	117
Control buttons	28
Current operating manual	12

D

Data export	163, 164
DC cables	69, 71, 73, 219
DC connections	49, 73, 83
DC switch	25, 74, 80, 81, 82, 197, 209
DHCP server	134
Display	47, 74, 84, 85, 86, 87
Disposal	219

E

EMS	30, 31
Ethernet	57, 60, 62, 110, 111, 112
Ethernet cable	112
EU declarations of conformity	11

F

Faults	161
Firmware	216

G

Grid monitoring	161, 216
-----------------------	----------

H

Hotline.....7, 217

I

Initial commissioning..... 74

Inputs 204

Interfaces..... 207

IP address 109, 118, 134, 170, 172, 177, 181

L

LAN..... 109

Language 2

Line circuit breaker 49, 74, 80, 82

Log data..... 131, 159, 162, 163

M

Menu..... 85, 96, 97

N

Notes 12, 14, 17

O

Open the inverter cover 110, 112, 219

Operation 85

Operational statuses..... 87

P

Proper use..... 8

Proxy server 109

PV generator 206

R

Ripple control receiver 57, 58, 59, 132

S

Safety instructions 14

Saving interval 39

Scope of delivery 45

Self-consumption 8, 144, 145, 146, 161, 183, 185, 187, 188, 189, 190, 192

Self-consumption control..... 146, 186, 188

Settings 28, 84, 94, 109, 112, 118, 164

Sleep mode..... 153, 154

Smart battery control..... 142, 155

Solar portal..... 163

Spring-loaded terminal strips 52

Storage 44

Strings..... 72, 74, 80, 81, 161

Switched output 186

T

Technical data 204

Terminal..... 51, 58, 185

Transport 44

Type plate..... 216, 217

W

Wall mount 48

Warnings 15

Warranty..... 9, 71, 217

Webserver 38, 110, 115, 116, 117, 132, 186

KOSTAL

KOSTAL Solar Electric GmbH
Hanferstr. 6
79108 Freiburg i. Br.
Germany
Telephone: +49 761 47744 - 100
Fax: +49 761 47744 - 111

KOSTAL Solar Electric Ibérica S.L.
Edificio abm
Ronda Narciso Monturiol y Estarriol, 3
Torre B, despachos 2 y 3
Parque Tecnológico de Valencia
46980 Valencia
España
Teléfono: +34 961 824 - 934
Fax: +34 961 824 - 931

KOSTAL Solar Electric France SARL
11, rue Jacques Cartier
78280 Guyancourt
France
Téléphone: +33 1 61 38 - 4117
Fax: +33 1 61 38 - 3940

KOSTAL Solar Electric Hellas E.Π.Ε.
47 Steliou Kazantzidi st., P.O. Box: 60080
1st building – 2nd entrance
55535, Pilea, Thessaloniki
Ελλάδα
Τηλέφωνο: +30 2310 477 - 550
Φαξ: +30 2310 477 - 551

KOSTAL Solar Electric Italia Srl
Via Genova, 57
10098 Rivoli (TO)
Italia
Telefono: +39 011 97 82 - 420
Fax: +39 011 97 82 - 432

www.kostal-solar-electric.com