

**SUN2000-(12K-25K)-MB0 Series**

# **User Manual**

**Issue**                04  
**Date**                 2023-11-02



**Copyright © Huawei Digital Power Technologies Co., Ltd. 2023. All rights reserved.**

No part of this document may be reproduced or transmitted in any form or by any means without prior written consent of Huawei Digital Power Technologies Co., Ltd.

## **Trademarks and Permissions**



HUAWEI and other Huawei trademarks are the property of Huawei Technologies Co., Ltd.

All other trademarks and trade names mentioned in this document are the property of their respective holders.

## **Notice**

The purchased products, services and features are stipulated by the contract made between Huawei Digital Power Technologies Co., Ltd. and the customer. All or part of the products, services and features described in this document may not be within the purchase scope or the usage scope. Unless otherwise specified in the contract, all statements, information, and recommendations in this document are provided "AS IS" without warranties, guarantees or representations of any kind, either express or implied. The information in this document is subject to change without notice. Every effort has been made in the preparation of this document to ensure accuracy of the contents, but all statements, information, and recommendations in this document do not constitute a warranty of any kind, express or implied.

## **Huawei Digital Power Technologies Co., Ltd.**

Address: Huawei Digital Power Antuoshan Headquarters  
Futian, Shenzhen 518043  
People's Republic of China

Website: <https://digitalpower.huawei.com>

# About This Document

## Purpose

This document describes the following inverter models (also referred to as SUN2000) in terms of the safety precautions, product introduction, installation, electrical connections, power-on and commissioning, maintenance, and technical specifications. Read this document carefully before installing and operating the SUN2000.

- SUN2000-12K-MB0
- SUN2000-15K-MB0
- SUN2000-17K-MB0
- SUN2000-20K-MB0
- SUN2000-25K-MB0
- SUN2000-15K-MB0-ZH
- SUN2000-17K-MB0-ZH
- SUN2000-20K-MB0-ZH
- SUN2000-25K-MB0-ZH


## Intended Audience





This document is intended for:

- Installers
- Users

## Symbol Conventions

The symbols that may be found in this document are defined as follows.

Symbol	Description
	Indicates a hazard with a high level of risk which, if not avoided, will result in death or serious injury.

Symbol	Description
 WARNING	Indicates a hazard with a medium level of risk which, if not avoided, could result in death or serious injury.
 CAUTION	Indicates a hazard with a low level of risk which, if not avoided, could result in minor or moderate injury.
 NOTICE	Indicates a potentially hazardous situation which, if not avoided, could result in equipment damage, data loss, performance deterioration, or unanticipated results. NOTICE is used to address practices not related to personal injury.
 NOTE	Supplements the important information in the main text. NOTE is used to address information not related to personal injury, equipment damage, and environment deterioration.

## Change History

Changes between document issues are cumulative. The latest document issue contains all the changes made in earlier issues.

### Issue 04 (2023-11-02)

- Updated [5.2 Connecting a PE Cable](#).
- Updated [5.3 Connecting an AC Output Power Cable](#).
- Updated [5.4 Connecting DC Input Power Cables](#).

### Issue 03 (2023-08-31)

Updated [2.2 Networking Application](#).

Updated [5.1 Preparing Cables](#).

Updated [5.6 Connecting Signal Cables](#).

Added [5.6.3 Connecting RS485 Communications Cables \(EMMA\)](#).

Added [5.6.5 Connecting RS485 Communications Cables \(EMMA and Battery\)](#).

Updated [7.2.3 Deploying a New Plant](#).

Updated [7.3.1 Setting Common Parameters](#).

Updated [8.1 Routine Maintenance](#).

Added [C Connecting to the EMMA](#).

Added [F Baud Rate Negotiation](#).

Added [G Contact Information](#).

Added [H Digital Power Customer Service](#).

Updated [I Certificate Management and Maintenance](#).

## **Issue 02 (2023-06-30)**

Updated [2.2 Networking Application](#).

Updated [2.4 Working Modes](#).

Updated [7.1 Powering On the Inverter](#).

Updated [7.2.2 \(Optional\) Registering an Installer Account](#).

Updated [7.2.3 Deploying a New Plant](#).

Updated [B Connecting to the Inverter](#).

Updated [7.4 Viewing the Plant Creation Status](#).

Added [5.5 \(Optional\) Connecting Battery Cables](#).

Added [5.6.4 Connecting RS485 Communications Cables \(Power Meter and Battery\)](#).

Added [7.5 SmartLogger Networking Scenario](#).

## **Issue 01 (2023-04-30)**

This issue is used for first office application (FOA).

---

# Contents

---

<b>About This Document.....</b>	<b>ii</b>
<b>1 Safety Information.....</b>	<b>1</b>
1.1 Personal Safety.....	2
1.2 Electrical Safety.....	4
1.3 Environment Requirements.....	6
1.4 Mechanical Safety.....	8
<b>2 Overview.....</b>	<b>13</b>
2.1 Model Number Description.....	13
2.2 Networking Application.....	14
2.3 Appearance.....	18
2.4 Working Modes.....	20
2.5 Label Description.....	21
<b>3 Storage Requirements.....</b>	<b>24</b>
<b>4 Installation.....</b>	<b>25</b>
4.1 Installation Modes.....	25
4.2 Installation Requirements.....	25
4.2.1 Site Selection Requirements.....	25
4.2.2 Clearance Requirements.....	26
4.2.3 Angle Requirements.....	27
4.3 Tools.....	28
4.4 Checking Before Installation.....	30
4.5 Moving an Inverter.....	30
4.6 Installing an Inverter (Wall Mounting).....	31
4.7 Installing an Inverter (Support Mounting).....	33
<b>5 Electrical Connections.....</b>	<b>35</b>
5.1 Preparing Cables.....	36
5.2 Connecting a PE Cable.....	39
5.3 Connecting an AC Output Power Cable.....	41
5.4 Connecting DC Input Power Cables.....	45
5.5 (Optional) Connecting Battery Cables.....	49
5.6 Connecting Signal Cables.....	51

5.6.1 Connecting the RS485 Communications Cable (Inverter Cascading).....	54
5.6.2 Connecting RS485 Communications Cables (Power Meter).....	55
5.6.3 Connecting RS485 Communications Cables (EMMA).....	62
5.6.4 Connecting RS485 Communications Cables (Power Meter and Battery).....	63
5.6.5 Connecting RS485 Communications Cables (EMMA and Battery).....	64
5.6.6 Connecting the Rapid shutdown signal cable.....	65
5.6.7 Connecting the Power Grid Scheduling Signal Cable.....	66
5.6.8 Connecting NS Protection Signal Cables.....	68
5.7 (Optional) Installing the Smart Dongle and Anti-theft Components.....	70
<b>6 Check Before Power-On.....</b>	<b>72</b>
<b>7 Power-On and Commissioning.....</b>	<b>73</b>
7.1 Powering On the Inverter.....	73
7.2 Creating a Plant.....	78
7.2.1 Downloading the FusionSolar App.....	78
7.2.2 (Optional) Registering an Installer Account.....	79
7.2.3 Deploying a New Plant.....	82
7.3 Commissioning Functions and Features.....	84
7.3.1 Setting Common Parameters.....	84
7.3.2 (Optional) Setting the Physical Layout of the Smart PV Optimizers.....	85
7.3.3 AFCI.....	86
7.4 Viewing the Plant Creation Status.....	88
7.5 SmartLogger Networking Scenario.....	89
<b>8 System Maintenance.....</b>	<b>90</b>
8.1 Routine Maintenance.....	90
8.2 System Power-Off.....	92
8.3 Troubleshooting.....	92
8.4 Replacing an Inverter.....	104
8.5 Replacing a Fan.....	105
8.6 Locating Insulation Resistance Faults.....	106
<b>9 Technical Specifications.....</b>	<b>109</b>
9.1 SUN2000-(15K-25K)-MB0-ZH Technical Specifications.....	109
9.2 SUN2000-(12K-25K)-MB0 Technical Specifications.....	118
<b>A Grid Codes.....</b>	<b>126</b>
<b>B Connecting to the Inverter.....</b>	<b>131</b>
<b>C Connecting to the EMMA.....</b>	<b>134</b>
<b>D Resetting Password.....</b>	<b>136</b>
<b>E Rapid Shutdown.....</b>	<b>137</b>
<b>F Baud Rate Negotiation.....</b>	<b>139</b>

---

<b>G Contact Information.....</b>	<b>142</b>
<b>H Digital Power Customer Service.....</b>	<b>144</b>
<b>I Certificate Management and Maintenance.....</b>	<b>145</b>
I.1 Preconfigured Certificate Risk Disclaimer.....	145
I.2 Application Scenarios of Preconfigured Certificates.....	146
<b>J Acronyms and Abbreviations.....</b>	<b>147</b>



# 1 Safety Information

---

## Statement

**Before transporting, storing, installing, operating, using, and/or maintaining the equipment, read this document, strictly follow the instructions provided herein, and follow all the safety instructions on the equipment and in this document.** In this document, "equipment" refers to the products, software, components, spare parts, and/or services related to this document; "the Company" refers to the manufacturer (producer), seller, and/or service provider of the equipment; "you" refers to the entity that transports, stores, installs, operates, uses, and/or maintains the equipment.

The **Danger, Warning, Caution, and Notice** statements described in this document do not cover all the safety precautions. You also need to comply with relevant international, national, or regional standards and industry practices. **The Company shall not be liable for any consequences that may arise due to violations of safety requirements or safety standards concerning the design, production, and usage of the equipment.**

The equipment shall be used in an environment that meets the design specifications. Otherwise, the equipment may be faulty, malfunctioning, or damaged, which is not covered under the warranty. The Company shall not be liable for any property loss, personal injury, or even death caused thereby.

Comply with applicable laws, regulations, standards, and specifications during transportation, storage, installation, operation, use, and maintenance.

Do not perform reverse engineering, decompilation, disassembly, adaptation, implantation, or other derivative operations on the equipment software. Do not study the internal implementation logic of the equipment, obtain the source code of the equipment software, violate intellectual property rights, or disclose any of the performance test results of the equipment software.

**The Company shall not be liable for any of the following circumstances or their consequences:**

- The equipment is damaged due to force majeure such as earthquakes, floods, volcanic eruptions, debris flows, lightning strikes, fires, wars, armed conflicts, typhoons, hurricanes, tornadoes, and other extreme weather conditions.
- The equipment is operated beyond the conditions specified in this document.

- The equipment is installed or used in environments that do not comply with international, national, or regional standards.
- The equipment is installed or used by unqualified personnel.
- You fail to follow the operation instructions and safety precautions on the product and in the document.
- You remove or modify the product or modify the software code without authorization.
- You or a third party authorized by you cause the equipment damage during transportation.
- The equipment is damaged due to storage conditions that do not meet the requirements specified in the product document.
- You fail to prepare materials and tools that comply with local laws, regulations, and related standards.
- The equipment is damaged due to your or a third party's negligence, intentional breach, gross negligence, or improper operations, or other reasons not related to the Company.

## 1.1 Personal Safety

---

 **DANGER**

Ensure that power is off during installation. Do not install or remove a cable with power on. Transient contact between the core of the cable and the conductor will generate electric arcs or sparks, which may cause a fire or personal injury.

---

---

 **DANGER**

Non-standard and improper operations on the energized equipment may cause fire, electric shocks, or explosion, resulting in property damage, personal injury, or even death.

---

---

 **DANGER**

Before operations, remove conductive objects such as watches, bracelets, bangles, rings, and necklaces to prevent electric shocks.

---

---

 **DANGER**

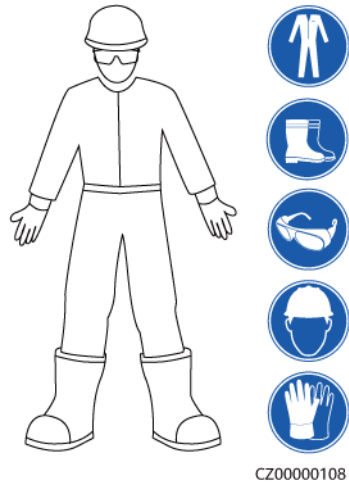
During operations, use dedicated insulated tools to prevent electric shocks or short circuits. The dielectric withstanding voltage level must comply with local laws, regulations, standards, and specifications.

---

 **WARNING**

During operations, wear personal protective equipment such as protective clothing, insulated shoes, goggles, safety helmets, and insulated gloves.

**Figure 1-1** Personal protective equipment



## General Requirements

- Do not stop protective devices. Pay attention to the warnings, cautions, and related precautionary measures in this document and on the equipment.
- If there is a likelihood of personal injury or equipment damage during operations, immediately stop, report the case to the supervisor, and take feasible protective measures.
- Do not power on the equipment before it is installed or confirmed by professionals.
- Do not touch the power supply equipment directly or with conductors such as damp objects. Before touching any conductor surface or terminal, measure the voltage at the contact point to ensure that there is no risk of electric shock.
- Do not touch operating equipment because the enclosure is hot.
- Do not touch a running fan with your hands, components, screws, tools, or boards. Otherwise, personal injury or equipment damage may occur.
- In the case of a fire, immediately leave the building or the equipment area and activate the fire alarm or call emergency services. Do not enter the affected building or equipment area under any circumstances.

## Personnel Requirements

- Only professionals and trained personnel are allowed to operate the equipment.
  - Professionals: personnel who are familiar with the working principles and structure of the equipment, trained or experienced in equipment operations and are clear of the sources and degree of various potential hazards in equipment installation, operation, maintenance

- Trained personnel: personnel who are trained in technology and safety, have required experience, are aware of possible hazards on themselves in certain operations, and are able to take protective measures to minimize the hazards on themselves and other people
- Personnel who plan to install or maintain the equipment must receive adequate training, be able to correctly perform all operations, and understand all necessary safety precautions and local relevant standards.
- Only qualified professionals or trained personnel are allowed to install, operate, and maintain the equipment.
- Only qualified professionals are allowed to remove safety facilities and inspect the equipment.
- Personnel who will perform special tasks such as electrical operations, working at heights, and operations of special equipment must possess the required local qualifications.
- Only authorized professionals are allowed to replace the equipment or components (including software).
- Only personnel who need to work on the equipment are allowed to access the equipment.

## 1.2 Electrical Safety

---

 **DANGER**

Before connecting cables, ensure that the equipment is intact. Otherwise, electric shocks or fire may occur.

---

---

 **DANGER**

Non-standard and improper operations may result in fire or electric shocks.

---

---

 **DANGER**

Prevent foreign matter from entering the equipment during operations. Otherwise, equipment damage, load power derating, power failure, or personal injury may occur.

---

---

 **WARNING**

For the equipment that needs to be grounded, install the ground cable first when installing the equipment and remove the ground cable last when removing the equipment.

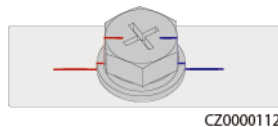
---

 **CAUTION**

Do not route cables near the air intake or exhaust vents of the equipment.

## General Requirements

- Follow the procedures described in the document for installation, operation, and maintenance. Do not reconstruct or alter the equipment, add components, or change the installation sequence without permission.
- Obtain approval from the national or local electric utility company before connecting the equipment to the grid.
- Observe the power plant safety regulations, such as the operation and work ticket mechanisms.
- Install temporary fences or warning ropes and hang "No Entry" signs around the operation area to keep unauthorized personnel away from the area.
- Before installing or removing power cables, turn off the switches of the equipment and its upstream and downstream switches.
- Before performing operations on the equipment, check that all tools meet the requirements and record the tools. After the operations are complete, collect all of the tools to prevent them from being left inside the equipment.
- Before installing power cables, check that cable labels are correct and cable terminals are insulated.
- When installing the equipment, use a torque tool of a proper measurement range to tighten the screws. When using a wrench to tighten the screws, ensure that the wrench does not tilt and the torque error does not exceed 10% of the specified value.
- Ensure that bolts are tightened with a torque tool and marked in red and blue after double-check. Installation personnel mark tightened bolts in blue. Quality inspection personnel confirm that the bolts are tightened and then mark them in red. (The marks must cross the edges of the bolts.)



- If the equipment has multiple inputs, disconnect all the inputs before operating the equipment.
- Before maintaining a downstream electrical or power distribution device, turn off the output switch on the power supply equipment.
- During equipment maintenance, attach "Do not switch on" labels near the upstream and downstream switches or circuit breakers as well as warning signs to prevent accidental connection. The equipment can be powered on only after troubleshooting is complete.
- Do not open equipment panels.
- Check equipment connections periodically, ensuring that all screws are securely tightened.
- Only qualified professionals can replace a damaged cable.
- Do not scrawl, damage, or block any labels or nameplates on the equipment. Promptly replace labels that have worn out.

- Do not use solvents such as water, alcohol, or oil to clean electrical components inside or outside of the equipment.

## Grounding

- Ensure that the grounding impedance of the equipment complies with local electrical standards.
- Ensure that the equipment is connected permanently to the protective ground. Before operating the equipment, check its electrical connection to ensure that it is reliably grounded.
- Do not work on the equipment in the absence of a properly installed ground conductor.
- Do not damage the ground conductor.

## Cabling Requirements

- When selecting, installing, and routing cables, follow local safety regulations and rules.
- When routing power cables, ensure that there is no coiling or twisting. Do not join or weld power cables. If necessary, use a longer cable.
- Ensure that all cables are properly connected and insulated, and meet specifications.
- Ensure that the slots and holes for routing cables are free from sharp edges, and that the positions where cables are routed through pipes or cable holes are equipped with cushion materials to prevent the cables from being damaged by sharp edges or burrs.
- Ensure that cables of the same type are bound together neatly and straight and that the cable sheath is intact. When routing cables of different types, ensure that they are away from each other without entanglement and overlapping.
- Secure buried cables using cable supports and cable clips. Ensure that the cables in the backfill area are in close contact with the ground to prevent cable deformation or damage during backfilling.
- If the external conditions (such as the cable layout or ambient temperature) change, verify the cable usage in accordance with the IEC-60364-5-52 or local laws and regulations. For example, check that the current-carrying capacity meets requirements.
- When routing cables, reserve at least 30 mm clearance between the cables and heat-generating components or areas. This prevents deterioration or damage to the cable insulation layer.

## 1.3 Environment Requirements

---

 **DANGER**

Do not expose the equipment to flammable or explosive gas or smoke. Do not perform any operation on the equipment in such environments.

---

---

 **DANGER**

Do not store any flammable or explosive materials in the equipment area.

---

---

 **DANGER**

Do not place the equipment near heat sources or fire sources, such as smoke, candles, heaters, or other heating devices. Overheat may damage the equipment or cause a fire.

---

---

 **WARNING**

Install the equipment in an area far away from liquids. Do not install it under areas prone to condensation, such as under water pipes and air exhaust vents, or areas prone to water leakage, such as air conditioner vents, ventilation vents, or feeder windows of the equipment room. Ensure that no liquid enters the equipment to prevent faults or short circuits.

---

---

 **WARNING**

To prevent damage or fire due to high temperature, ensure that the ventilation vents or heat dissipation systems are not obstructed or covered by other objects while the equipment is running.

---

## General Requirements

- Ensure that the equipment is stored in a clean, dry, and well ventilated area with proper temperature and humidity and is protected from dust and condensation.
- Keep the installation and operating environments of the equipment within the allowed ranges. Otherwise, its performance and safety will be compromised.
- Do not install, use, or operate outdoor equipment and cables (including but not limited to moving equipment, operating equipment and cables, inserting connectors to or removing connectors from signal ports connected to outdoor facilities, working at heights, performing outdoor installation, and opening doors) in harsh weather conditions such as lightning, rain, snow, and level 6 or stronger wind.
- Do not install the equipment in an environment with dust, smoke, volatile or corrosive gases, infrared and other radiations, organic solvents, or salty air.
- Do not install the equipment in an environment with conductive metal or magnetic dust.
- Do not install the equipment in an area conducive to the growth of microorganisms such as fungus or mildew.
- Do not install the equipment in an area with strong vibration, noise, or electromagnetic interference.

- Ensure that the site complies with local laws, regulations, and related standards.
- Ensure that the ground in the installation environment is solid, free from spongy or soft soil, and not prone to subsidence. The site must not be located in a low-lying land prone to water or snow accumulation, and the horizontal level of the site must be above the highest water level of that area in history.
- Do not install the equipment in a position that may be submerged in water.
- If the inverter is installed in a place with abundant vegetation, in addition to routine weeding, harden the ground underneath the inverter using cement or gravel (the area shall be greater than or equal to 3 m x 2.5 m).
- Do not install the equipment outdoors in salt-affected areas because it may be corroded. A salt-affected area refers to the region within 500 m of the coast or prone to sea breeze. Regions prone to sea breeze vary with weather conditions (such as typhoons and monsoons) or terrains (such as dams and hills).
- Before installation, operation, and maintenance, clean up any water, ice, snow, or other foreign objects on the top of the equipment.
- When installing the equipment, ensure that the installation surface is solid enough to bear the weight of the equipment.
- After installing the equipment, remove the packing materials such as cartons, foam, plastics, and cable ties from the equipment area.

## 1.4 Mechanical Safety

---

 **WARNING**

Ensure that all necessary tools are ready and inspected by a professional organization. Do not use tools that have signs of scratches or fail to pass the inspection or whose inspection validity period has expired. Ensure that the tools are secure and not overloaded.

---

---

 **WARNING**

Do not drill holes into the equipment. Doing so may affect the sealing performance and electromagnetic containment of the equipment and damage components or cables inside. Metal shavings from drilling may short-circuit boards inside the equipment.

---

### General Requirements

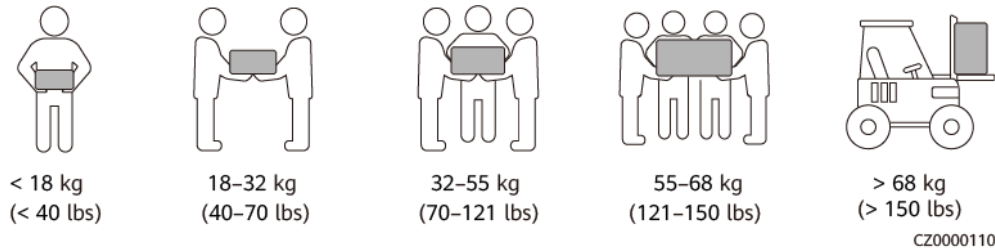
- Repaint any paint scratches caused during equipment transportation or installation in a timely manner. Equipment with scratches must not be exposed for an extended period of time.
- Do not perform operations such as arc welding and cutting on the equipment without evaluation by the Company.



- Do not install other devices on the top of the equipment without evaluation by the Company.
- When performing operations over the top of the equipment, take measures to protect the equipment against damage.
- Use correct tools and operate them in the correct way.

## Moving Heavy Objects

- Be cautious to prevent injury when moving heavy objects.



- If multiple persons need to move a heavy object together, determine the manpower and work division with consideration of height and other conditions to ensure that the weight is equally distributed.
- If two persons or more move a heavy object together, ensure that the object is lifted and landed simultaneously and moved at a uniform pace under the supervision of one person.
- Wear personal protective gears such as protective gloves and shoes when manually moving the equipment.
- To move an object by hand, approach to the object, squat down, and then lift the object gently and stably by the force of the legs instead of your back. Do not lift it suddenly or turn your body around.
- Do not quickly lift a heavy object above your waist. Place the object on a workbench that is half-waist high or any other appropriate place, adjust the positions of your palms, and then lift it.
- Move a heavy object stably with balanced force at an even and low speed. Put down the object stably and slowly to prevent any collision or drop from scratching the surface of the equipment or damaging the components and cables.
- When moving a heavy object, be aware of the workbench, slope, staircase, and slippery places. When moving a heavy object through a door, ensure that the door is wide enough to move the object and avoid bumping or injury.
- When transferring a heavy object, move your feet instead of turning your waist around. When lifting and transferring a heavy object, ensure that your feet point to the target direction of movement.
- When transporting the equipment using a pallet truck or forklift, ensure that the tynes are properly positioned so that the equipment does not topple. Before moving the equipment, secure it to the pallet truck or forklift using ropes. When moving the equipment, assign dedicated personnel to take care of it.
- Choose sea, roads in good conditions, or airplanes for transportation. Do not transport the equipment by railway. Avoid tilt or jolt during transportation.

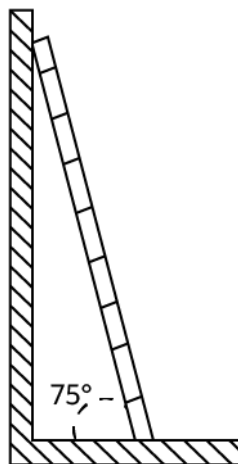
## Using Ladders

- Use wooden or insulated ladders when you need to perform live-line working at heights.
- Platform ladders with protective rails are preferred. Single ladders are not recommended.
- Before using a ladder, check that it is intact and confirm its load bearing capacity. Do not overload it.
- Ensure that the ladder is securely positioned and held firm.



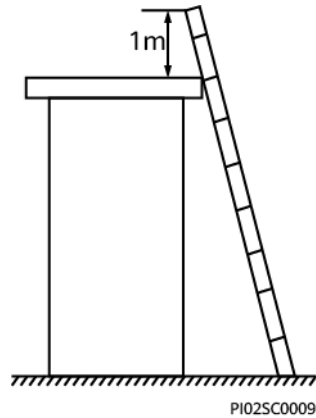
CZ00000107

- When climbing up the ladder, keep your body stable and your center of gravity between the side rails, and do not overreach to the sides.
- When a step ladder is used, ensure that the pull ropes are secured.
- If a single ladder is used, the recommended angle for the ladder against the floor is 75 degrees, as shown in the following figure. A square can be used to measure the angle.



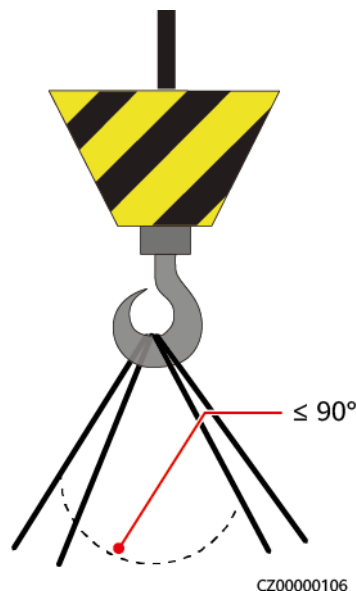
PI025C0008

- If a single ladder is used, ensure that the wider end of the ladder is at the bottom, and take protective measures to prevent the ladder from sliding.
- If a single ladder is used, do not climb higher than the fourth rung of the ladder from the top.
- If you use a single ladder to climb up to a platform, ensure that the ladder is at least 1 m higher than the platform.



## Hoisting

- Only trained and qualified personnel are allowed to perform hoisting operations.
- Install temporary warning signs or fences to isolate the hoisting area.
- Ensure that the foundation where hoisting is performed on meets the load-bearing requirements.
- Before hoisting objects, ensure that hoisting tools are firmly secured onto a fixed object or wall that meets the load-bearing requirements.
- During hoisting, do not stand or walk under the crane or the hoisted objects.
- Do not drag steel ropes and hoisting tools or bump the hoisted objects against hard objects during hoisting.
- Ensure that the angle between two hoisting ropes is no more than 90 degrees, as shown in the following figure.



## Drilling Holes

- Obtain consent from the customer and contractor before drilling holes.
- Wear protective equipment such as safety goggles and protective gloves when drilling holes.

- To avoid short circuits or other risks, do not drill holes into buried pipes or cables.
- When drilling holes, protect the equipment from shavings. After drilling, clean up any shavings.

# 2 Overview

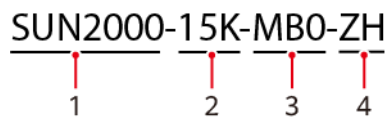
The SUN2000 is a three-phase grid-tied PV string inverter that converts the DC power generated by PV strings into AC power and feeds the power into the power grid.

## 2.1 Model Number Description

This document involves the following product models:

- SUN2000-12K-MB0
- SUN2000-15K-MB0
- SUN2000-17K-MB0
- SUN2000-20K-MB0
- SUN2000-25K-MB0
- SUN2000-15K-MB0-ZH
- SUN2000-17K-MB0-ZH
- SUN2000-20K-MB0-ZH
- SUN2000-25K-MB0-ZH

**Figure 2-1** Model number (using SUN2000-15K-MB0-ZH as an example)



**Table 2-1** Model number description

No.	Item	Description
1	Series name	SUN2000: three-phase grid-tied PV string inverter

No.	Item	Description
2	Power	<ul style="list-style-type: none"><li>• 12K: The rated power is 12 kW.</li><li>• 15K: The rated power is 15 kW.</li><li>• 17K: The rated power is 17 kW.</li><li>• 20K: The rated power is 20 kW.</li><li>• 25K: The rated power is 25 kW.</li></ul>
3	Design code	MB0: three-phase product series with the DC input voltage level of 1000 V or 1100 V
4	Region	ZH: China

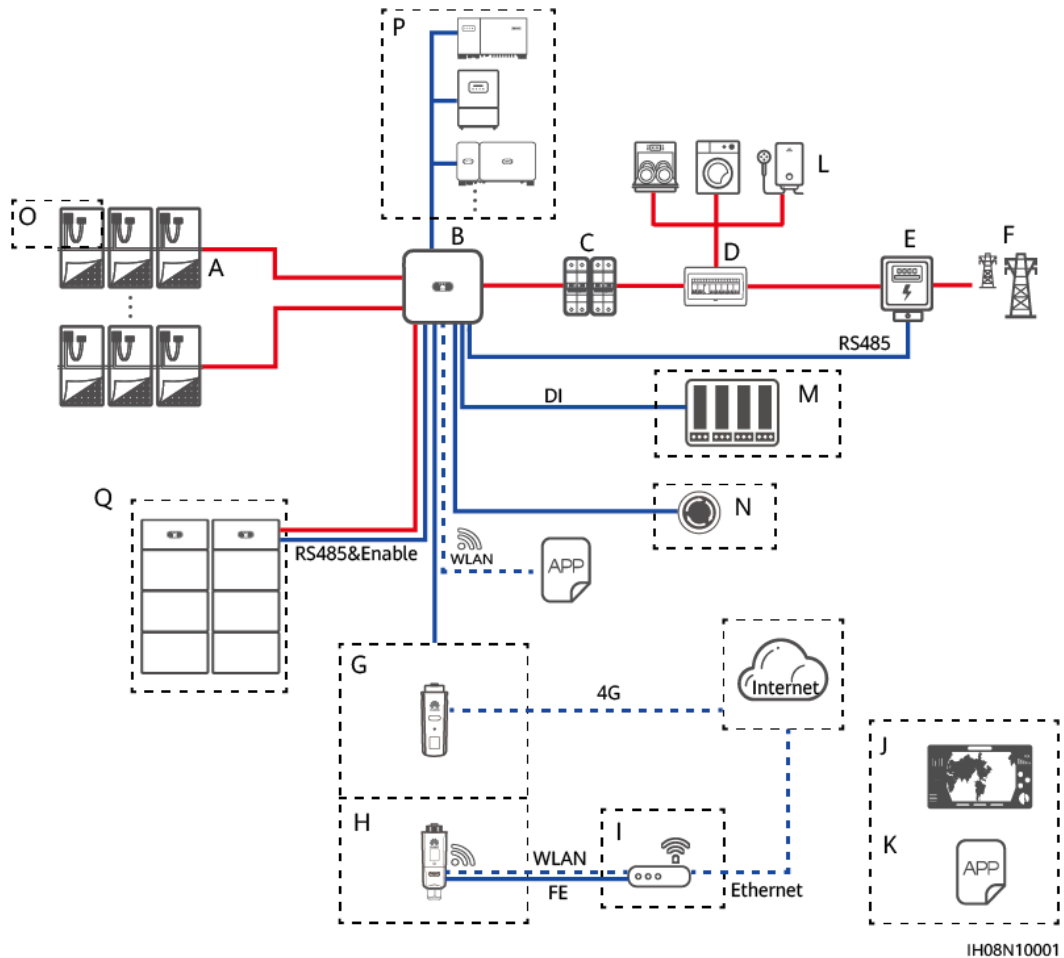
## 2.2 Networking Application

### Typical Networking

The SUN2000 applies to residential rooftop grid-tied systems and small-sized ground grid-tied PV plants. The system consists of PV strings, grid-tied inverters, AC switches, and power distribution units (PDUs).

#### Smart Dongle networking

**Figure 2-2** Smart Dongle networking (the components in dashed boxes are optional)



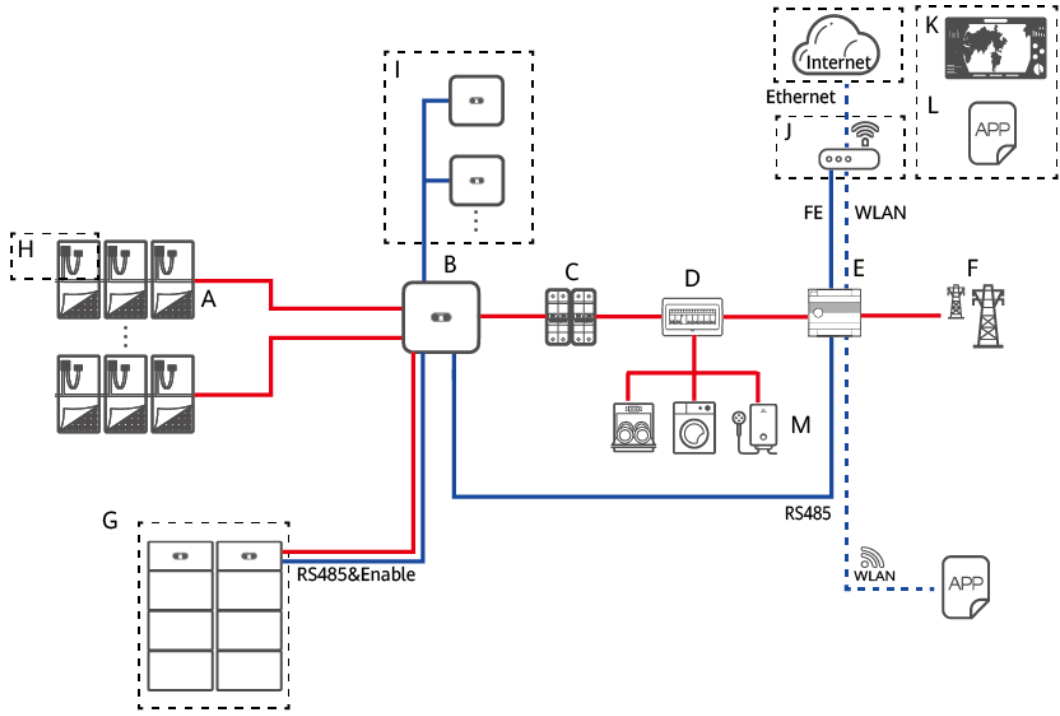
- |                                   |                           |                |
|-----------------------------------|---------------------------|----------------|
| (A) PV string                     | (B) SUN2000               | (C) AC switch  |
| (D) AC PDU                        | (E) Power meter           | (F) Power grid |
| (G) 4G Smart Dongle               | (H) WLAN-FE Smart Dongle  | (I) Router     |
| (J) FusionSolar management system | (K) FusionSolar app       | (L) Load       |
| (M) Power grid scheduling device  | (N) Rapid shutdown switch | (O) Optimizer  |
| (P) Slave devices                 | (Q) Battery               |                |

**NOTE**

In the Smart Dongle networking, inverters cannot be cascaded in the PV+ESS scenario.

**EMMA networking**

**Figure 2-3** EMMA networking (the components in dashed boxes are optional)

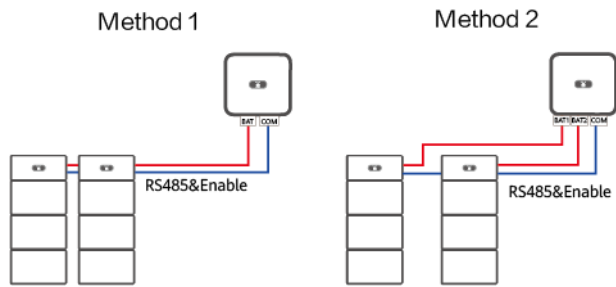


IH09N10001

- (A) PV string
- (B) SUN2000
- (C) AC switch
- (D) AC PDU
- (E) EMMA
- (F) Power grid
- (G) Battery
- (H) Optimizer
- (I) Slave devices
- (J) Router
- (K) FusionSolar management system
- (L) FusionSolar app
- (M) Load

When the SUN2000 is equipped with multiple batteries, there are two connection methods, as shown in the following figure.

**Figure 2-4** Connection methods for the SUN2000 equipped with batteries



IH08N10005



**NOTE**

For details about operations on related products in the network, see the following documents:

[SUN2000-\(600W-P, 450W-P2\) Smart PV Optimizer Quick Guide](#)

[SUN2000 Smart PV Optimizer User Manual](#)

[MERC-\(1300W, 1100W\)-P Smart PV Optimizer Quick Guide](#)

[MERC Smart PV Optimizer User Manual](#)

[LUNA2000-\(5-30\)-S0 User Manual](#)

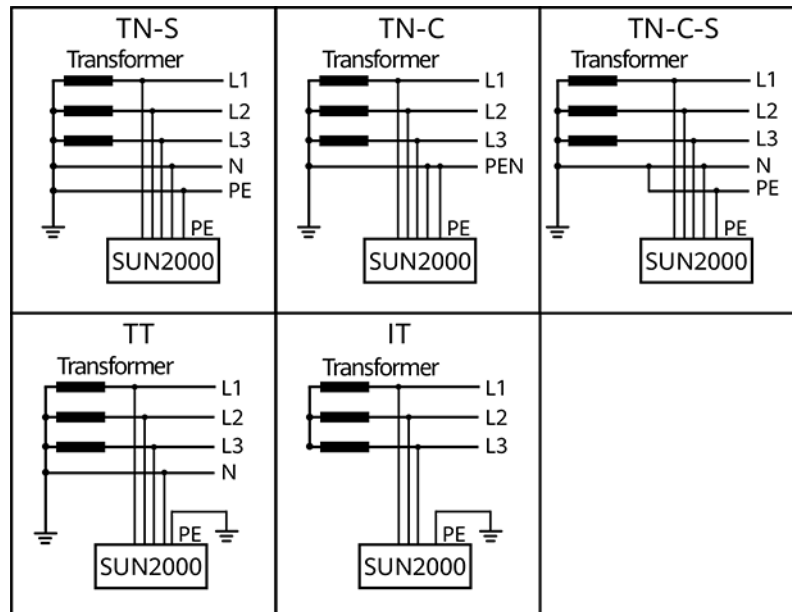
**NOTE**

- For two PV strings connected in parallel to the same MPPT circuit, the model, quantity, orientation, and tilt angle of PV modules in the PV strings must be the same.
- The voltage of different MPPT circuits must be the same.
- The MPPT voltage must be greater than the lower threshold of the full-load MPPT range specified in the inverter technical data sheet. Otherwise, the inverter will be derated, causing the system yield loss.

## Power Grid Types

Power grid types supported by the SUN2000 include TN-S, TN-C, TN-C-S, TT, and IT.

**Figure 2-5** Supported power grids



IS01S10001

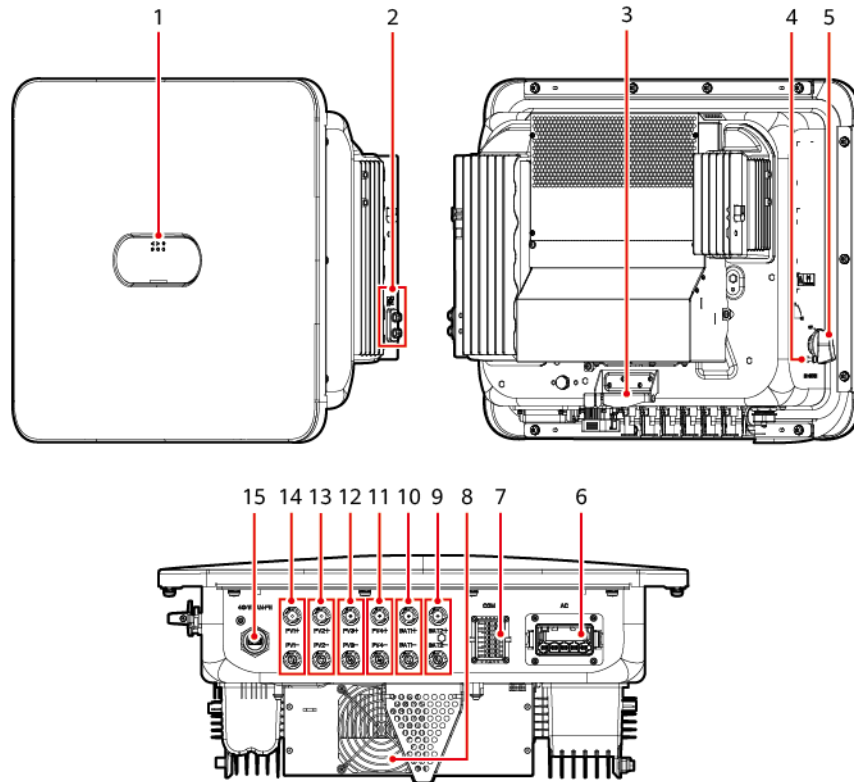
**NOTE**

- In a TT power grid, the N-PE voltage should be lower than 30 V.
- In an IT power grid, you need to set **isolation settings to input not grounded, with a transformer.**

## 2.3 Appearance

### Appearance and Ports

Figure 2-6 Appearance



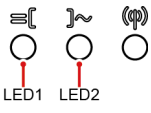
IH08W00001

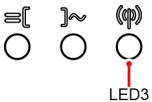
- |   |   |
|---|---|
| (1) LED indicators                      | (2) Ground screws                               |
| (3) Mounting bracket                    | (4) DC switch locking screw hole <sup>[1]</sup> |
| (5) DC switch (DC SWITCH)               | (6) AC output port (AC)                         |
| (7) Communications port (COM)           | (8) Fan   |
| (9) Battery terminals (BAT2+ and BAT2-) | (10) Battery terminals (BAT1+ and BAT1-)        |
| (11) DC input terminals (PV4+ and PV4-) | (12) DC input terminals (PV3+ and PV3-)         |
| (13) DC input terminals (PV2+ and PV2-) | (14) DC input terminals (PV1+ and PV1-)         |
| (15) Smart Dongle port (4G/WLAN-FE)     |   |

Note [1]: For models used in Australia, the DC switch locking screw needs to be installed according to the local standard to secure the DC switch (DC SWITCH) and prevent incorrect startup. The DC switch locking screw is delivered with the product.

## Indicator Description

Table 2-2 LED indicator description

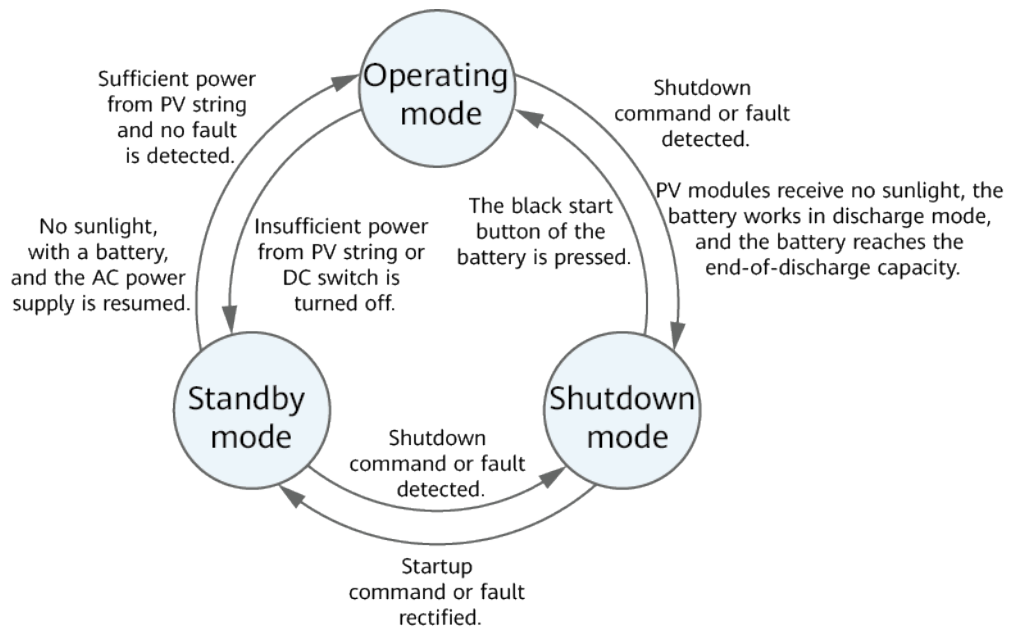
Category	Status		Description
Running indication 	<b>LED1</b>	<b>LED2</b>	-
	Steady green	Steady green	The inverter is operating in grid-tied mode.
	Blinking green slowly (on for 1s and off for 1s)	Off	The DC is on and the AC is off.
	Blinking green slowly (on for 1s and off for 1s)	Blinking green slowly (on for 1s and off for 1s)	Both the DC and AC are on, and the inverter is off-grid.
	Off	Blinking green slowly (on for 1s and off for 1s)	The DC is off and the AC is on.
	Off	Off	Both the DC and AC are off.
	Blinking red fast (on for 0.2s and off for 0.2s)	-	There is a DC environmental alarm, such as <b>High String Input Voltage, String Reverse Connection, or Low Insulation Resistance.</b>
	-	Blinking red fast	There is an AC environmental alarm, such as <b>Grid Undervoltage, Grid Overvoltage, Grid Overfrequency, or Grid Underfrequency.</b>
	Steady red	Steady red	A fault exists.

Category	Status			Description
Communica tion indication  	<b>LED3</b>			-
	Blinking green fast (on for 0.2s and off for 0.2s)			Communication is in progress. (When a mobile phone is connected to the inverter, the indicator first blinks green slowly, indicating that the phone is connected to the inverter.)
	Blinking green slowly (on for 1s and off for 1s)			The mobile phone is connected to the inverter.
	Off			There is no communication.
Device replacement indication	<b>LED1</b>	<b>LED2</b>	<b>LED3</b>	-
	Steady red	Steady red	Steady red	The inverter hardware is faulty and needs to be replaced.

## 2.4 Working Modes

The SUN2000 can work in Standby, Operating, or Shutdown mode.

Figure 2-7 Working modes



IS07S00002

**Table 2-3** Working mode description


Working Mode	Description
Standby	<p>The SUN2000 enters Standby mode when the external environment does not meet the operating requirements. In Standby mode:</p> <ul style="list-style-type: none"> <li>• The SUN2000 continuously performs status check and enters the Operating mode once the operating requirements are met.</li> <li>• The SUN2000 enters Shutdown mode after detecting a shutdown command or a fault after startup.</li> </ul>
Operating	<p>In Operating mode:</p> <ul style="list-style-type: none"> <li>• The SUN2000 converts DC power from PV strings into AC power and feeds the power to the power grid.</li> <li>• The SUN2000 tracks the maximum power point to maximize the PV string output.</li> <li>• If the SUN2000 detects a fault or a shutdown command, it enters the Shutdown mode.</li> <li>• The SUN2000 enters Standby mode after detecting that the PV string output power is not suitable for connecting to the power grid for generating power.</li> <li>• If the PV modules receive no sunlight, the battery works in discharge mode, and the battery reaches the end-of-discharge capacity, the SUN2000 enters Shutdown mode.</li> </ul>
Shutdown	<ul style="list-style-type: none"> <li>• In Standby or Operating mode, the SUN2000 enters Shutdown mode after detecting a fault or shutdown command.</li> <li>• In Shutdown mode, the SUN2000 enters Standby mode after detecting a startup command or that the fault is rectified.</li> <li>• In Shutdown mode, if the black start button of the battery is pressed, the SUN2000 enters Operating mode.</li> </ul>

## 2.5 Label Description

### Enclosure Labels

Symbol	Name	Meaning
	Delayed discharge	Residual voltage exists after the inverter is powered off. It takes 5 minutes for the inverter to discharge to the safe voltage.

Symbol	Name	Meaning
	Burn warning	Do not touch the inverter when it is running because its enclosure is hot.
	Electric shock warning	<ul style="list-style-type: none"> <li>High voltage exists after the inverter is powered on. Only qualified and trained electrical technicians are allowed to perform operations on the inverter.</li> <li>High touch current exists after the inverter is powered on. Before powering on the inverter, ensure that the inverter is properly grounded.</li> </ul>
	Refer to documentation	Reminds operators to refer to the documents delivered the inverter.
	Grounding	Indicates the position for connecting the protective earthing (PE) cable.
	Operation warning	Do not remove the DC input connector or AC output connector when the inverter is running.
	Weight	The inverter is heavy and needs to be carried by two persons.
	Serial number (SN)	Indicates the product SN.

Symbol	Name	Meaning
	QR code for inverter WiFi connection	Scan the QR code to connect to the Huawei inverter WiFi.

## Product Nameplate

The nameplate contains the trademark, product model, important technical specifications, compliance symbols, company name, and place of origin.

### NOTE

Scan the QR code on the nameplate to view related product information and documents.

# 3 Storage Requirements

---

The following requirements shall be met if inverters are not put into use immediately:

- Do not unpack inverters.
- Keep the storage temperature at  $-40^{\circ}\text{C}$  to  $+70^{\circ}\text{C}$  and the humidity at 5%–95% RH.
- Store inverters in a clean and dry place and protect them from dust and moisture.
- Inverters can be stacked in a maximum of six layers. To avoid personal injury or device damage, stack inverters with caution to prevent them from falling over.
- During the storage period, check inverters periodically (recommended: once every three months). Replace the packing materials that are damaged by insects or rodents in a timely manner.
- If inverters have been stored for two years or longer, they must be checked and tested by professionals before being put into use.



# 4 Installation

## 4.1 Installation Modes

The inverter can be wall-mounted or support-mounted.

**Table 4-1** Installation modes

Installation Mode	Screw Specifications	Description
Wall mounting	M6x60 stainless steel expansion bolt	Delivered with the product
Support mounting	M6 stainless steel bolt assembly	Prepared by the customer

## 4.2 Installation Requirements

### 4.2.1 Site Selection Requirements

#### Basic Requirements

- The inverter is protected to IP66 and can be installed indoors or outdoors.
- Do not install the inverter in an easily accessible place because its enclosure and heat sinks generate high temperature during operation.
- Do not install the inverter in noise-sensitive areas.
- Do not install the inverter in areas with flammable or explosive materials.
- Do not install the inverter in a place within children's reach.
- Do not install the inverter outdoors in salt areas because it will be corroded there and may cause fire. A salt area refers to a region within 500 m of the coast or prone to sea breeze. Regions prone to sea breeze vary with weather

conditions (such as typhoons and monsoons) or terrains (such as dams and hills).

- The inverter should be installed in a well-ventilated environment to ensure good heat dissipation.
- You are advised to install the inverter in a sheltered area, or with an awning over it.

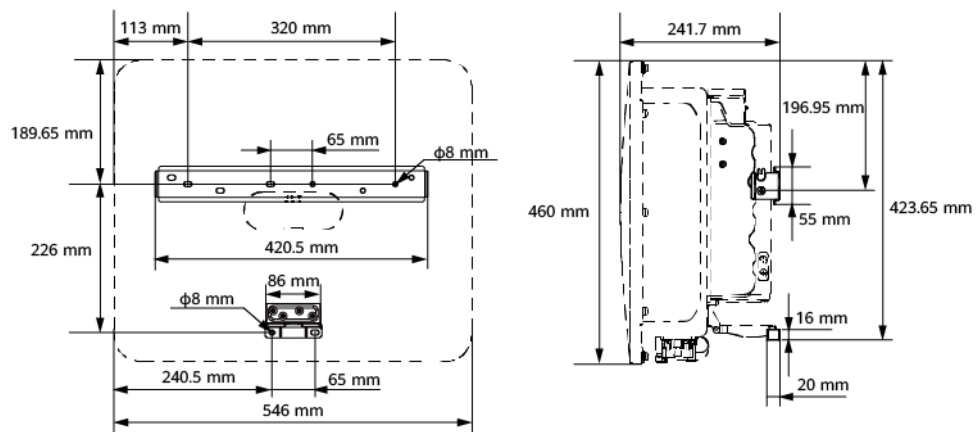
### Mounting Structure Requirements

- The mounting structure where the inverter is installed must be fireproof.
- Do not install the inverter on flammable building materials.
- The inverter is heavy. Ensure that the installation surface is solid enough to bear the weight.
- In residential areas, do not install the inverter on drywalls or walls made of similar materials which have a weak sound insulation performance because the noise generated by the inverter is noticeable.

### 4.2.2 Clearance Requirements

- **Figure 4-1** shows the dimensions of mounting holes for the inverter.

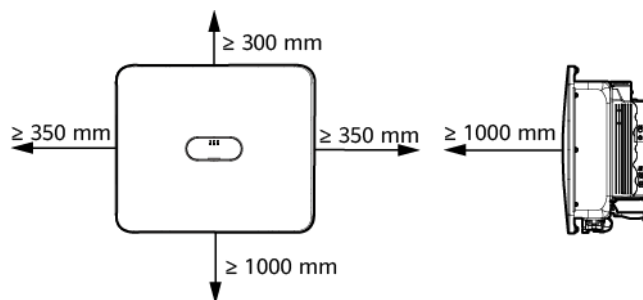
**Figure 4-1** Dimensions of the inverter and mounting bracket



IH08W00007

- Reserve enough clearances around the inverter to ensure sufficient space for installation and heat dissipation.

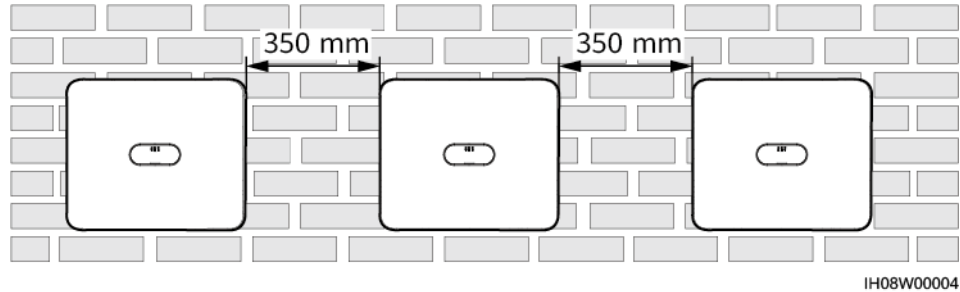
**Figure 4-2** Clearances



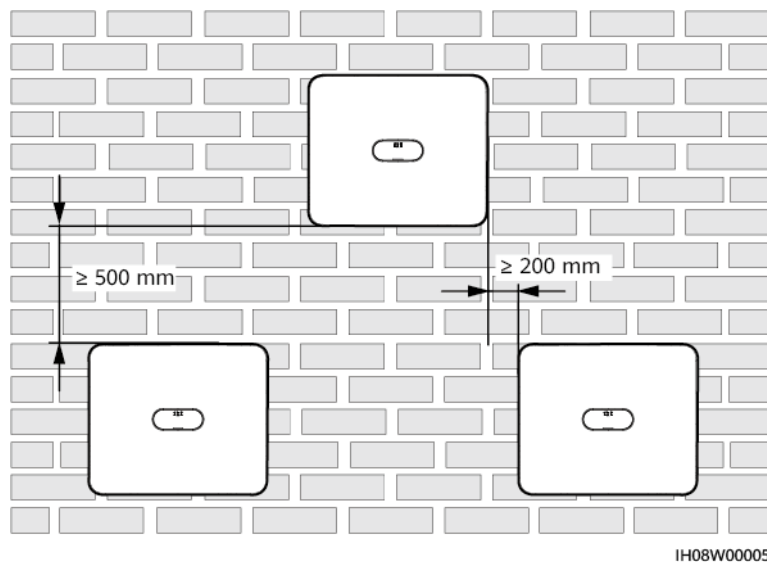
IH08W00003

- When installing multiple inverters, install them in horizontal mode if sufficient space is available and install them in triangle mode if no sufficient space is available. Stacked installation is not recommended.

**Figure 4-3** Horizontal installation mode (recommended)



**Figure 4-4** Triangle installation mode (recommended)

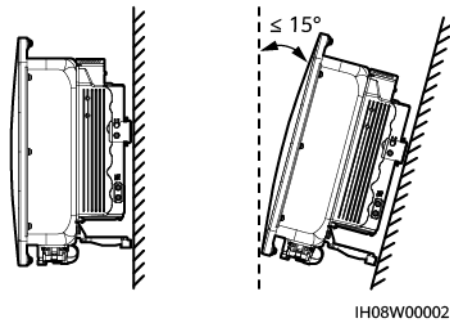


### 4.2.3 Angle Requirements

The inverter can be wall-mounted or support-mounted. The installation angle requirements are as follows:

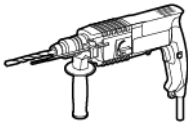

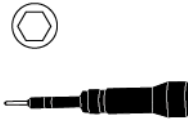

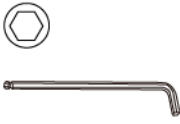
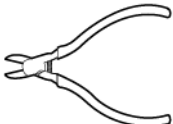
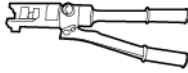
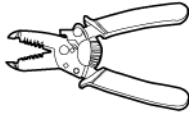




- Install the inverter vertically or at a maximum back tilt of 15 degrees to facilitate heat dissipation.
- Do not install the inverter at forward tilted, excessive backward tilted, side tilted, horizontal, or upside down positions.


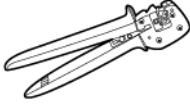
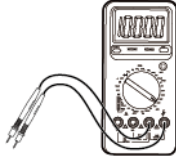

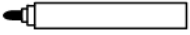
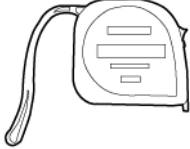

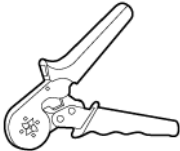
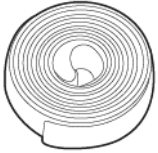



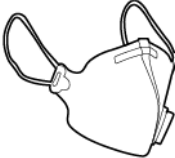



Figure 4-5 Installation angle



IH08W00002

### 4.3 Tools

Type	Tool			
Installation tool	 Hammer drill Drill bit: $\Phi 8$ mm, $\Phi 6$ mm	 Phillips insulated torque screwdriver	 Hex insulated torque screwdriver	 Insulated torque socket wrench
	 Hex key	 Diagonal pliers	 Hydraulic pliers	 Wire stripper
	 Cable tie	 Removal wrench Model: PV-MS-HZ open-end wrench Manufacturer: Staubli	 Rubber mallet	 Utility knife

Type	Tool			
	 Cable cutter	 Crimping tool Model: PV-CZM-22100/19100 Manufacturer: Staubli	 Multimeter DC voltage measurement range $\geq 1100$ V DC	 Vacuum cleaner
	 Marker	 Steel measuring tape	 Level	 Cord end terminal crimping tool
	 Heat shrink tubing	 Heat gun	-	-
Personal protective equipment (PPE)	 Insulated gloves	 Protective gloves	 Dust mask	 Insulated shoes
	 Goggles	 Safety helmet	-	-

## 4.4 Checking Before Installation

### Outer Packing Materials

Before unpacking the inverter, check the outer packing materials for damage, such as holes and cracks, and check the inverter model. If any damage is found or the inverter model is not what you requested, do not unpack the package and contact your supplier as soon as possible.

 **NOTE**

You are advised to remove the packing materials within 24 hours before installing the inverter.

### Package Contents

---

**NOTICE**

- After placing the equipment in the installation position, unpack it with care to prevent scratches. Keep the equipment stable during unpacking.

---

After unpacking the inverter, check that the contents are intact and complete. If any damage is found or any component is missing, contact your supplier.

 **NOTE**

For details about the number of contents, see the *Packing List* in the packing case.

## 4.5 Moving an Inverter

### Procedure

- Step 1** Two persons are required to move the inverter with one person on both sides. Lift the inverter from the packing case and move it to the specified installation position.

---

 **CAUTION**

- Move the inverter with care to prevent device damage and personal injury.
- Do not hold the wiring terminals and ports at the bottom. Do not place the inverter with the wiring terminals and ports touching the ground or other supporting surface.
- When you need to temporarily place the inverter on the ground, use protection material such as foam and paper underneath to prevent damage to its enclosure.

---

----End

## 4.6 Installing an Inverter (Wall Mounting)

### Procedure

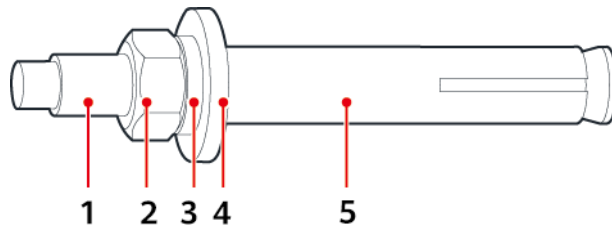
**Step 1** Determine the hole positions and mark them using a marker.

**Step 2** Secure the mounting bracket.

 **NOTE**

- M6x60 expansion bolts are delivered with the SUN2000. If the length and amount of the bolts do not meet installation requirements, prepare M6 stainless steel expansion bolts by yourself.
- The expansion bolts delivered with the inverter are used for solid concrete walls. For other types of walls, prepare bolts by yourself and ensure that the wall meets the load bearing requirements of the inverter.

**Figure 4-6** M6 expansion bolt structure



IS05W00018

(1) Bolt

(2) Nut

(3) Spring washer

(4) Flat washer

(5) Expansion sleeve

---

 **DANGER**

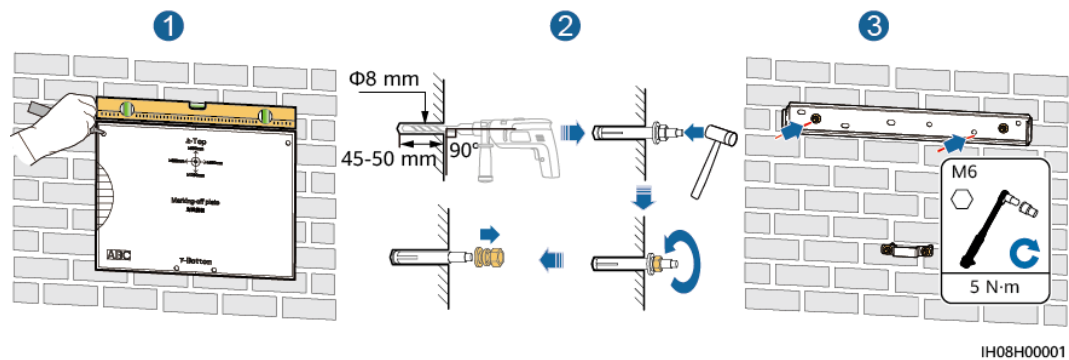
Avoid drilling holes in the utility pipes or cables attached to the back of the wall.

---

**NOTICE**

- To prevent dust inhalation or contact with eyes, wear safety goggles and an anti-dust respirator when drilling holes.
- Clean up any dust in and around the holes using a vacuum cleaner and measure the distance between holes. If large hole tolerance exists, position and drill holes again.
- After removing the bolt, spring washer, and flat washer, level the front of the expansion tube with the concrete wall. Otherwise, the mounting brackets will not stay steady on the concrete wall.
- Partially loosen the nut, flat washer and spring washer of the two expansion bolts below.

**Figure 4-7** Installing the mounting bracket

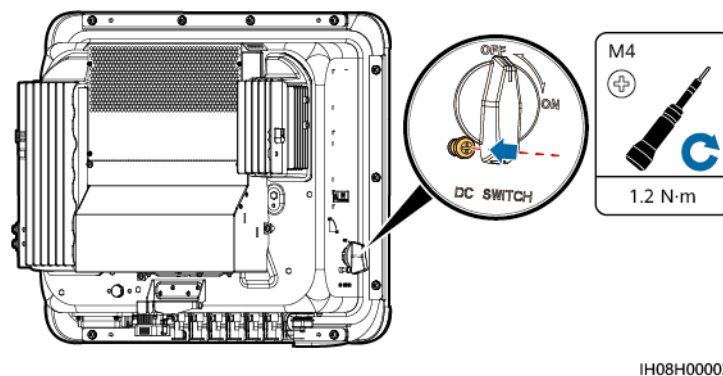


**Step 3** (Optional) Install the DC switch locking screw.

**NOTE**

- The DC switch locking screw is delivered with the inverter. According to the Australian standard, the locking screw is used to lock the DC SWITCH to prevent the inverter from being started by mistake.
- Perform this step for models used in Australia based on local standards.

**Figure 4-8** Installing the DC switch locking screw

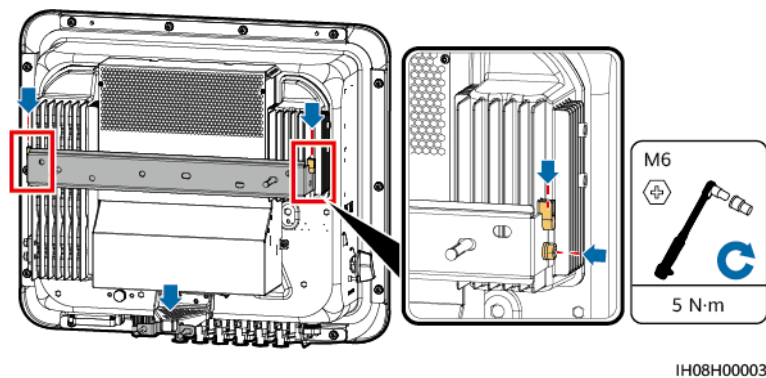


**Step 4** Install the inverter on the mounting bracket.

**Step 5** Tighten the nuts.



Figure 4-9 Installing the inverter



----End

## 4.7 Installing an Inverter (Support Mounting)

### Prerequisites

Prepare M6 stainless steel bolt assemblies (including flat washers, spring washers, and M6 bolts) with appropriate lengths as well as matched flat washers and nuts based on the support specifications.

### Procedure

**Step 1** Determine the positions for drilling holes using the marking-off template, and then mark the positions with a marker.

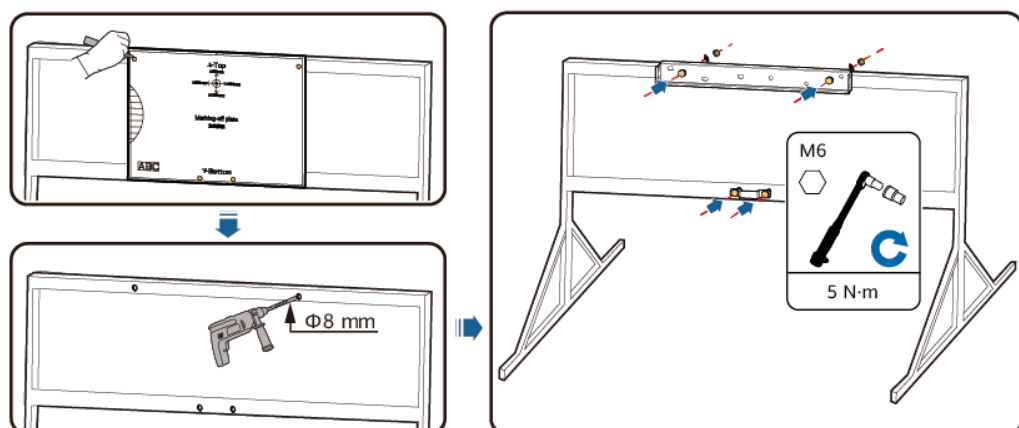
**Step 2** Drill holes using a hammer drill.

 **NOTE**

You are advised to apply anti-rust paint on the hole positions for protection.

**Step 3** Secure the mounting bracket.

Figure 4-10 Securing the mounting bracket

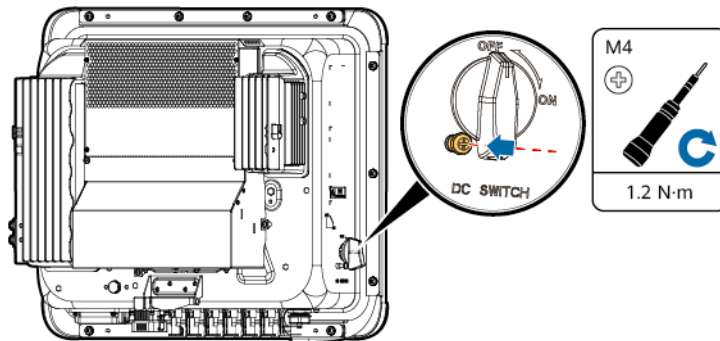


**Step 4** (Optional) Install the DC switch locking screw.

**NOTE**

- The DC switch locking screw is delivered with the inverter. According to the Australian standard, the locking screw is used to lock the DC SWITCH to prevent the inverter from being started by mistake.
- Perform this step for models used in Australia based on local standards.

**Figure 4-11** Installing the DC switch locking screw

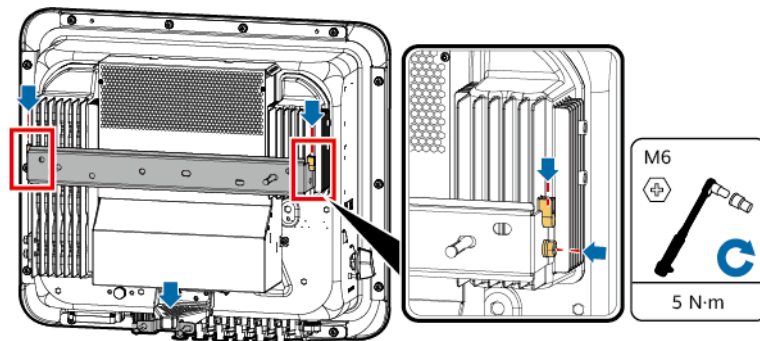


IH08H00002

**Step 5** Install the inverter on the mounting bracket.

**Step 6** Tighten the bolt assemblies.

**Figure 4-12** Installing an Inverter



IH08H00003

----End

# 5 Electrical Connections

---

## Precautions

---

 **DANGER**

When exposed to sunlight, the PV arrays supply DC voltage to the inverter. Before connecting cables, ensure that all **DC SWITCH** on the inverter are OFF. Otherwise, the high voltage of the inverter may result in electric shocks.

---

---

 **DANGER**

- The site must be equipped with qualified fire fighting facilities, such as fire sand and carbon dioxide fire extinguishers.
  - Wear personal protective equipment and use dedicated insulated tools to avoid electric shocks or short circuits.
- 

---

 **WARNING**

- The equipment damage caused by incorrect cable connections is beyond the warranty scope.
  - Only certified electrician can perform electrical terminations.
  - Operation personnel must wear PPE when connecting cables.
  - Before connecting cables to ports, leave enough slack to reduce the tension on the cables and prevent poor cable connections.
-

**CAUTION**

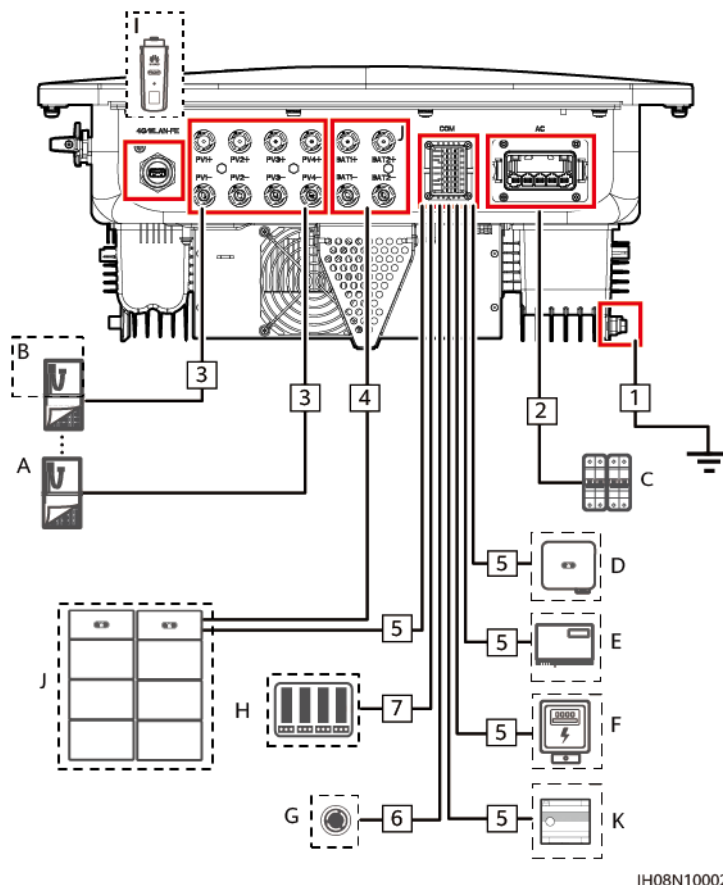
- Stay away from the equipment when preparing cables to prevent cable scraps from entering the equipment. Cable scraps may cause sparks and result in personal injury and equipment damage.
- When routing PV cables whose pipe is less than 1.5 m long, the positive and negative PV string cables shall be routed in different pipes to prevent cable damage and short circuits caused by improper operations during construction.

**NOTE**

The cable colors shown in the electrical connection diagrams provided in this section are for reference only. Select cables in accordance with local cable specifications (green-and-yellow cables are only used for protective earthing).

## 5.1 Preparing Cables

**Figure 5-1** SUN2000 cable connections (the components in dashed boxes are optional)



**Table 5-1** Component description

No.	Component	Description	Source
A	PV module	<ul style="list-style-type: none"> <li>A PV string consists of PV modules connected in series.</li> <li>The inverter supports 4 PV string inputs.</li> </ul>	Prepared by the customer
B	Smart PV Optimizer	Supported models: SUN2000-(600W-P, 450W-P2) and MERC-(1300W, 1100W)-P <sup>[3]</sup>	Purchased from Huawei
C	AC switch	<p>To ensure that the inverter can be safely disconnected from the power grid when an exception occurs, connect an AC switch to the AC side of the inverter. Select an appropriate AC switch in accordance with local industry standards and regulations. Huawei recommends the following switch specifications:</p> <p>Single-phase AC circuit breaker with a rated voltage greater than or equal to 415 V AC and a rated current of:</p> <ul style="list-style-type: none"> <li>12K-20K: 40 A</li> <li>25K: 50 A or 63 A</li> </ul>	Prepared by the customer
D	SUN2000	Select a proper model as required.	Purchased from Huawei
E	SmartLogger	Select a proper model as required.	Purchased from Huawei
F	Power meter <sup>[1]</sup>	The recommended power meter models are DTSU666-H, DTSU666-HW, YDS60-80 and YDS60-C24 <sup>[4]</sup> .	Purchased from Huawei
G	Rapid shutdown switch	Select a proper model as required.	Prepared by the customer
H	Power grid scheduling device	Select the device that meets the power grid scheduling requirements.	Provided by the local power grid company
I	Smart Dongle <sup>[2]</sup>	<p>Supported models:</p> <ul style="list-style-type: none"> <li>WLAN-FE Smart Dongle: SDongleA-05</li> <li>4G Smart Dongle: SDongleB-06</li> </ul>	Purchased from Huawei

No.	Component	Description	Source
J	Battery	The inverter can connect to the LUNA2000.	Purchased from Huawei
K	EMMA <sup>[5]</sup>	Supported models: EMMA-A01 and EMMA-A02	Purchased from Huawei
<p>Note [1]: For details about how to operate a power meter, see <a href="#">DTSU666-HW Smart Power Sensor Quick Guide</a>, <a href="#">DTSU666-H 100 A and 250 A Smart Power Sensor User Manual</a>, <a href="#">YDS60-80 Smart Power Sensor Quick Guide</a>, and <a href="#">YDS60-C24 Smart Power Sensor Quick Guide</a>.</p> <p>Note [2]: For details about how to operate a WLAN-FE Smart Dongle SDongleA-05, see <a href="#">SDongleA-05 Smart Dongle Quick Guide (WLAN-FE)</a>. For details about how to operate a 4G Smart Dongle SDongleB-06, see <a href="#">SDongleB-06 Smart Dongle Quick Guide (4G)</a>. You can obtain these documents at <a href="https://support.huawei.com/enterprise">https://support.huawei.com/enterprise</a> by searching for models.</p> <p>Note [3]: SUN2000-(600W-P, 450W-P2) and MERC-(1300W, 1100W)-P cannot be used together.</p> <p>Note [4]: Retain the default baud rates for the DTSU666-H and YDS60-C24 power meters. If they are changed, the power meters may go offline, generate alarms, or affect the inverter output power.</p> <p>Note [5]: For details about how to operate an EMMA, see <a href="#">EMMA-(A01, A02) Quick Guide</a>.</p>			

**Table 5-2** Cable description

No.	Name	Type	Conductor Cross-Sectional Area	Outer Diameter
1	PE cable	Single-core outdoor copper cable	12K: $\geq 6 \text{ mm}^2$ 15K-25K: $\geq 10 \text{ mm}^2$	-
2	AC output power cable	Five-core outdoor copper cable	12K: 6-16 $\text{mm}^2$ 15K-25K: 10-16 $\text{mm}^2$	11-26 mm
3	DC input power cable	Common outdoor PV cable in the industry	4-6 $\text{mm}^2$	5.5-9 mm
4	(Optional) Battery cable			
5	(Optional) RS485 communications cable	Two-core outdoor shielded twisted pair cable	0.2-1 $\text{mm}^2$ (0.5 $\text{mm}^2$ recommended)	4-11 mm

No.	Name	Type	Conductor Cross-Sectional Area	Outer Diameter
6	(Optional) Signal cable to the rapid shutdown switch			
7	(Optional) Grid scheduling signal cable	Five-core outdoor cable		

 NOTE

- The minimum cable diameter must meet local standards.
- The factors that affect cable selection include the rated current, cable type, routing mode, ambient temperature, and maximum expected line loss.

## 5.2 Connecting a PE Cable

### Precautions

 **DANGER**

- Ensure that the PE cable is securely connected. Otherwise, electric shocks may occur.
- Do not connect the neutral wire to the enclosure as a PE cable. Otherwise, electric shocks may occur.

 NOTE

- The PE point at the AC output port is used only as a PE equipotential point, and cannot substitute for the PE point on the enclosure.
- It is recommended that silicone grease or paint be applied around the ground terminal after the PE cable is connected.
- When the phase wire is short-circuited to the PE point, you can set the phase-to-PE short-circuit protection switch on the app (choose **Settings > Feature parameters > Phase-to-ground short-circuit protection**). If the switch is disabled, only inverter alarm detection is performed, and the inverter can connect to the power grid and generate power normally. (This feature is applicable to SUN2000-15K-MB0-ZH, SUN2000-17K-MB0-ZH, SUN2000-20K-MB0-ZH, and SUN2000-25K-MB0-ZH.)

### Additional Information

The inverter provides the grounding detection function. This function is used to check whether the inverter is properly grounded before the inverter starts, or check whether the ground cable is disconnected when the inverter is running. This function is only available under limited conditions. To ensure the safe operation of

the inverter, properly ground the inverter according to the connection requirements of the PE cable. For some power grid types, if the output side of the inverter is connected to an isolation transformer, ensure that the inverter is properly grounded and then set **Phase-to-ground short-circuit protection** to **Disable** so that the inverter can run properly.

- According to IEC 62109, to ensure the safe operation of the inverter in the case of PE cable damage or disconnection, properly connect the PE cable of the inverter and ensure that it meets at least one of the following requirements before the grounding detection function becomes invalid.
  - If the PE terminal of the AC connector is not connected, the PE cable on the enclosure must be a single-core outdoor copper cable with a cross-sectional area of at least 10 mm<sup>2</sup>.
  - Use cables with the same diameter as the AC output power cable and ground the PE terminal on the AC connector and the ground screws on the enclosure.
- In some countries and regions, the inverter must have additional ground cables. In this case, use cables with the same diameter as the AC output power cable to ground the PE terminal of the AC connector and the ground screws of the enclosure, respectively.

## Procedure

### Step 1 Crimp an OT terminal.

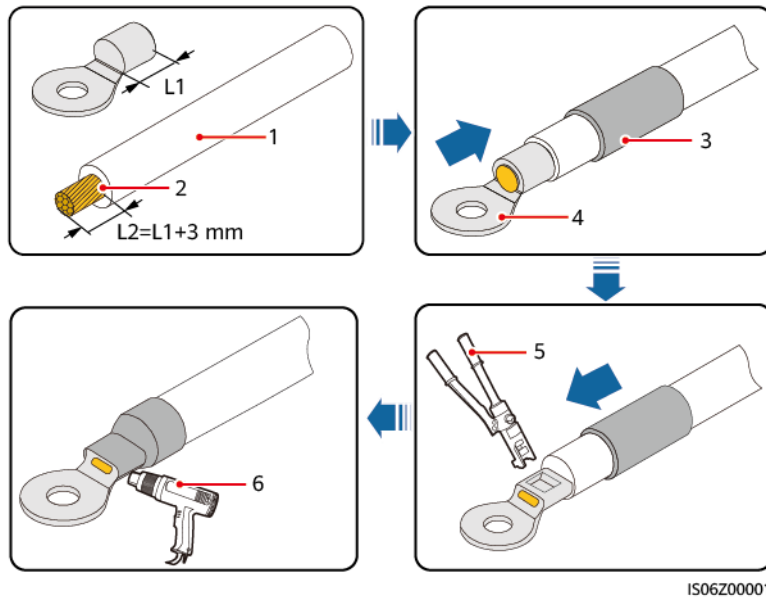
---

#### NOTICE

- Avoid scratching the core wire when stripping a cable.
  - The cavity formed after the conductor crimp strip of the OT terminal is crimped must wrap the core wire completely. The core wire must make close contact with the OT terminal.
  - Wrap the wire crimping area with heat shrink tubing or insulation tape. The heat shrink tubing is used as an example.
  - Use a heat gun carefully to avoid heat damage to the equipment.
-



**Figure 5-2** Crimping an OT terminal

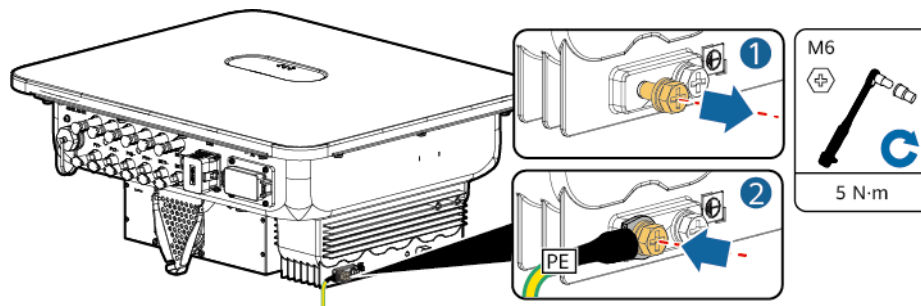


IS06Z00001

- |                 |                      |                        |
|-----------------|----------------------|------------------------|
| (1) Cable       | (2) Core wire        | (3) Heat shrink tubing |
| (4) OT terminal | (5) Hydraulic pliers | (6) Heat gun           |

**Step 2** Connect the PE cable.

**Figure 5-3** Connecting the PE cable



IH08150001

----End

## 5.3 Connecting an AC Output Power Cable

### Precautions

It is recommended that a three-phase AC switch be installed on the AC side of the inverter. To ensure that the inverter can safely disconnect itself from the power grid when an exception occurs, select a proper overcurrent protection device in compliance with local power distribution regulations.

**WARNING**

- Do not connect loads between an inverter and an AC switch that directly connects to the inverter. Otherwise, the switch may trip by mistake.
- If an AC switch is used with specifications beyond local standards, regulations, or the Company's recommendations, the switch may fail to turn off in a timely manner in case of exceptions, causing serious faults.

**CAUTION**

Each inverter shall be equipped with an AC output switch. Multiple inverters shall not connect to the same AC switch.

The inverter is installed with an integrated monitoring unit for the residual current. When the inverter detects that the residual current exceeds the permitted value, it disconnects from the power grid quickly.

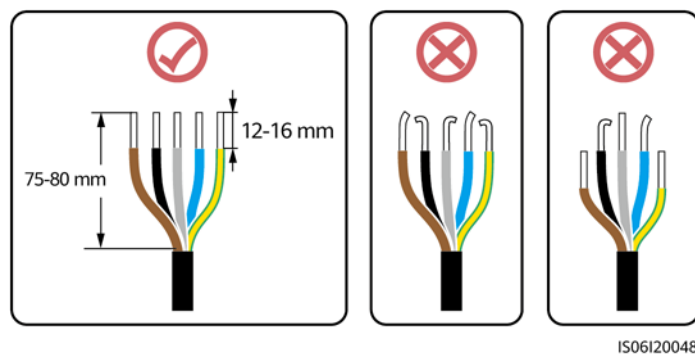
**NOTICE**

- If the external AC switch has residual current protection, its rated leakage tripping current must be greater than or equal to 300 mA.
- If multiple inverters are connected to the master leakage protection device through their AC switches, the rated leakage tripping current of the device must be greater than or equal to the number of inverters x 300 mA.
- The AC switch cannot be a knife switch.

## Procedure

**Step 1** Connect the AC output power cable to the AC connector.

**Figure 5-4** Wire stripping requirements



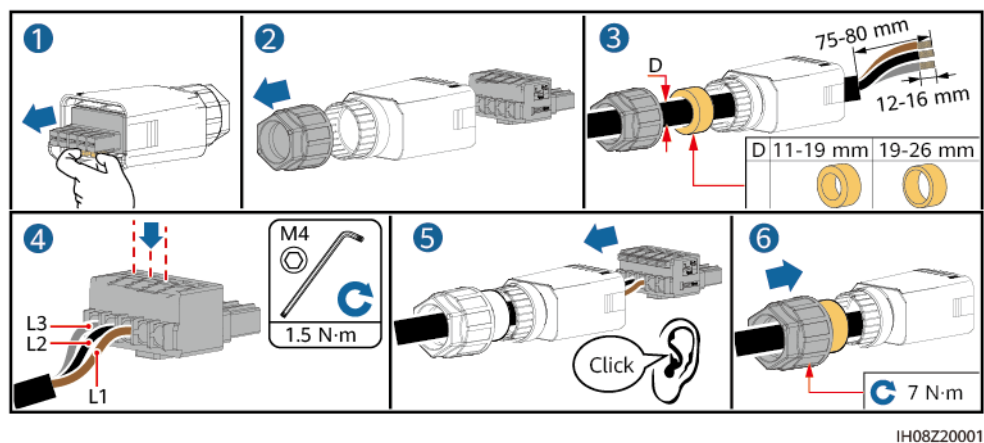
**NOTICE**

- Ensure that the cable jacket is inside the connector.
- Insert the exposed core wires completely into the holes.
- Connect the AC output cable securely. Otherwise, the device may fail to operate properly or the AC connector may be damaged.
- Ensure that the cable is not twisted.

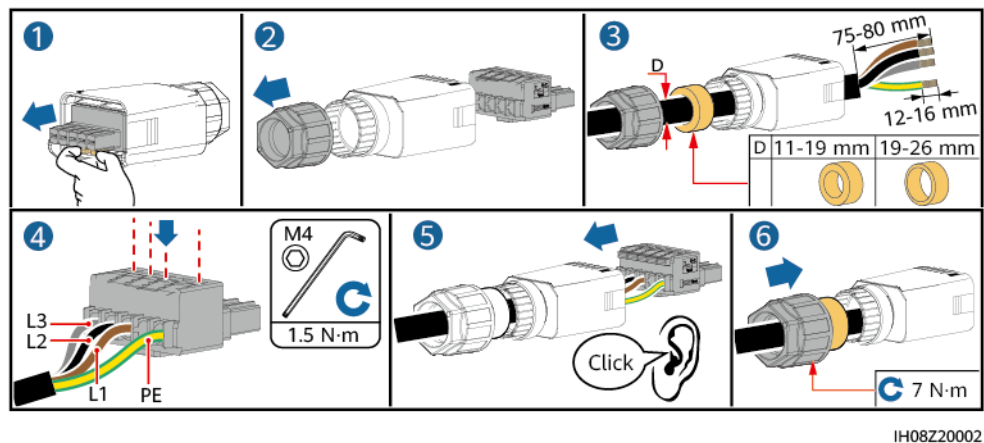
**NOTICE**

Strip the insulation layers of the AC output power cable by the recommended length (12–16 mm) to ensure that the cable conductors are completely inside the conductor insertion points and no insulation layer is pressed into the conductor insertion points. Tighten the cable conductors to a torque of 1.5 N·m. Otherwise, the device may fail to run properly or be damaged during operation.

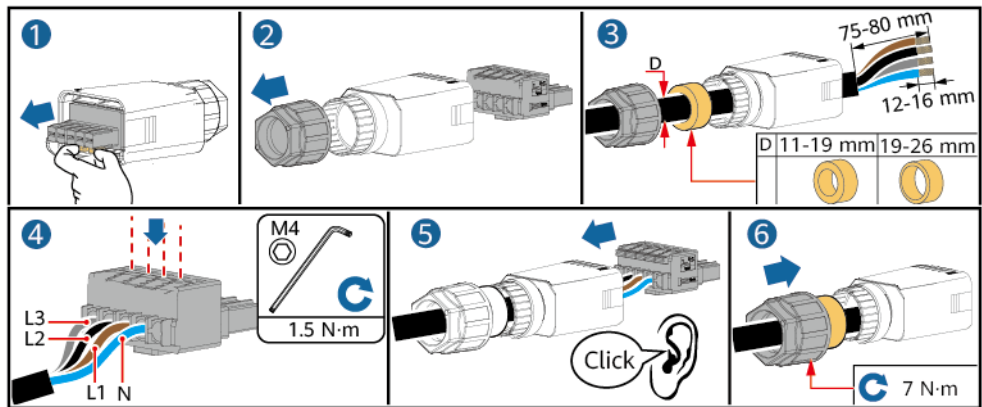
**Figure 5-5** Three-core cable (L1, L2, and L3)



**Figure 5-6** Four-core cable (L1, L2, L3, and PE)

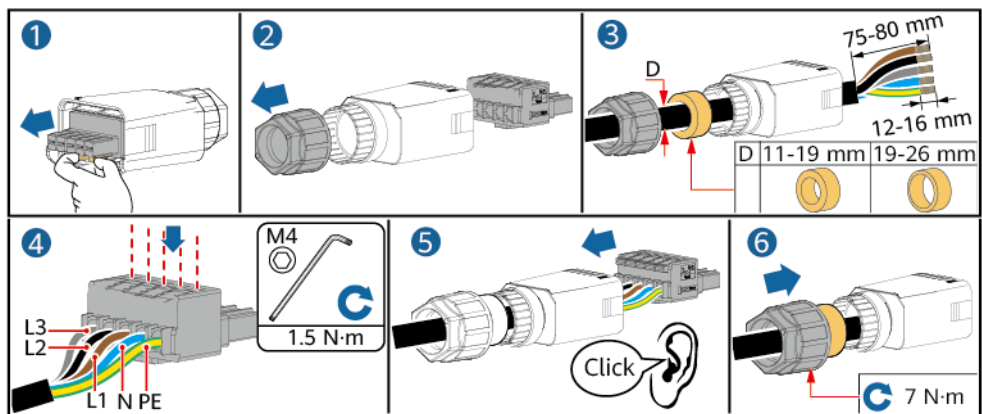


**Figure 5-7** Four-core cable (L1, L2, L3, and N)



IH08Z20003

**Figure 5-8** Five-core cable (L1, L2, L3, N, and PE)



IH08Z20004

**NOTE**

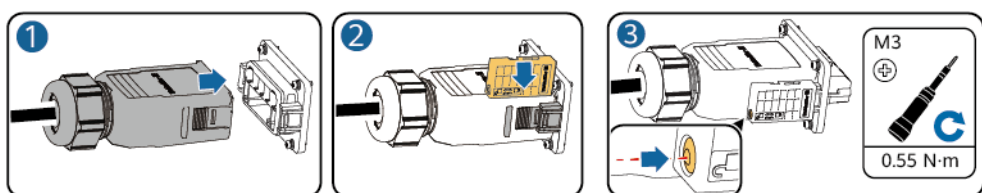
The cable colors shown in the figures are for reference only. Select an appropriate cable according to the local standards.

**Step 2** Connect the AC connector to the AC output port.

**NOTICE**

Ensure that the AC connector is connected securely.

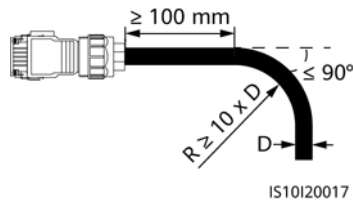
**Figure 5-9** Securing the AC connector



IH08H00006

**Step 3** Check the route of the AC output power cable.

**Figure 5-10** Cabling requirements



----End

## Disconnection

Perform the steps in reverse order to disconnect the cable.

## 5.4 Connecting DC Input Power Cables

### Precautions

---

**⚠ DANGER**

- Before connecting the DC input power cables, ensure that the DC voltage is within the safe range (lower than 60 V DC) and that the DC SWITCH on the inverter is OFF. Otherwise, the high voltage may result in electric shocks.
- When the inverter is operating, do not perform maintenance or operations on the DC input power cables, such as connecting or disconnecting a PV string or a PV module in the PV string. Otherwise, electric shocks may occur.
- If no PV string connects to a DC input terminal of the inverter, do not remove the waterproof cap from the DC input terminal. Otherwise, the protection level of the inverter will decrease.

---

**⚠ WARNING**

Ensure that the following conditions are met. Otherwise, the inverter may be damaged or even a fire may occur.

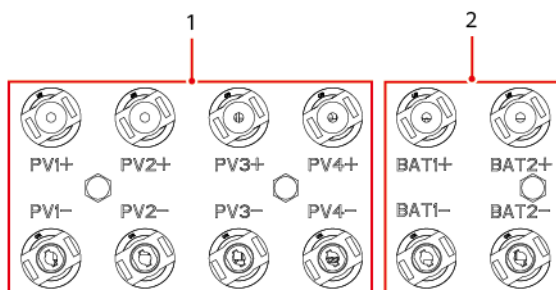
- PV modules connected in series in each PV string are of the same specifications.
  - The maximum open-circuit voltage of each PV string must be lower than or equal to 1100 V DC under any circumstances.
  - The polarities of electric connections are correct on the DC input side. The positive and negative terminals of a PV string connect to corresponding positive and negative DC input terminals of the inverter.
  - If a DC input power cable is reversely connected, do not immediately operate on the DC SWITCH or positive/negative connectors. Wait until the night when solar irradiance declines and the PV string current drops to below 0.5 A. Then set the DC SWITCH to OFF, remove the positive and negative connectors, and correct the polarities of the DC input power cable.
-

**NOTICE**

- The output of the PV string connected to the inverter cannot be grounded. Ensure that the PV module output is well insulated to ground.
- The PV strings connected to the same MPPT circuit shall contain the same number and model of PV modules or optimizers.
- During the installation of PV strings and the inverter, the positive or negative terminals of PV strings may be short-circuited to ground if the power cables are not properly installed or routed. In this case, an AC or DC short circuit may occur and damage the inverter. The resulting device damage is not covered by the product warranty.

## Terminal Description

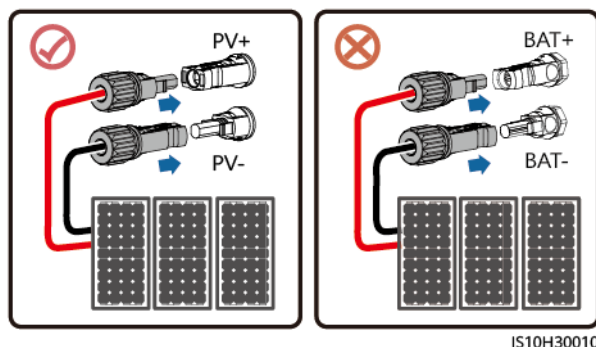
Figure 5-11 Terminals



(1) DC input terminals

(2) Battery terminals

Figure 5-12 Connection



## Procedure

**⚠ WARNING**

Before inserting the positive and negative connectors into the positive and negative DC input terminals of the inverter, ensure that the DC SWITCH is set to OFF.

---

**NOTICE**

- Cables with high rigidity, such as armored cables, are not recommended as DC input power cables, because poor contact may be caused by the bending of the cables.
  - Before assembling DC connectors, label the cable polarities correctly to ensure correct cable connections.
  - After crimping the positive and negative metal terminals, pull the DC input power cables back to ensure that they are connected securely.
  - Insert the crimped metal terminals of the positive and negative power cables into the appropriate positive and negative connectors. Then pull back the DC input power cables to ensure that they are connected securely.
  - If a DC input power cable is reversely connected and the DC SWITCH is set to ON, do not immediately operate on the DC SWITCH or the positive/negative connectors. Otherwise, the device may be damaged. The resulting device damage is not covered by the product warranty. Wait until the night when solar irradiance declines and the PV string current drops to below 0.5 A. Then set the DC SWITCH to OFF, remove the positive and negative connectors, and correct the polarities of the DC input power cable.
- 

**NOTE**

- The multimeter must have a DC voltage range of at least 1100 V. If the voltage is a negative value, the DC input polarity is incorrect. Rectify the connection. If the voltage is greater than 1100 V, too many PV modules are connected to the same string. Remove some PV modules.
- If PV strings are configured with optimizers, check the cable polarities by referring to the *Smart PV Optimizer Quick Guide*.

**Step 1** Connect DC input power cables.

---

**CAUTION**

Use the Staubli MC4 positive and negative metal terminals and DC connectors delivered with the inverter. Using incompatible positive and negative metal terminals and DC connectors may result in serious consequences. The resulting device damage is not covered by the product warranty.

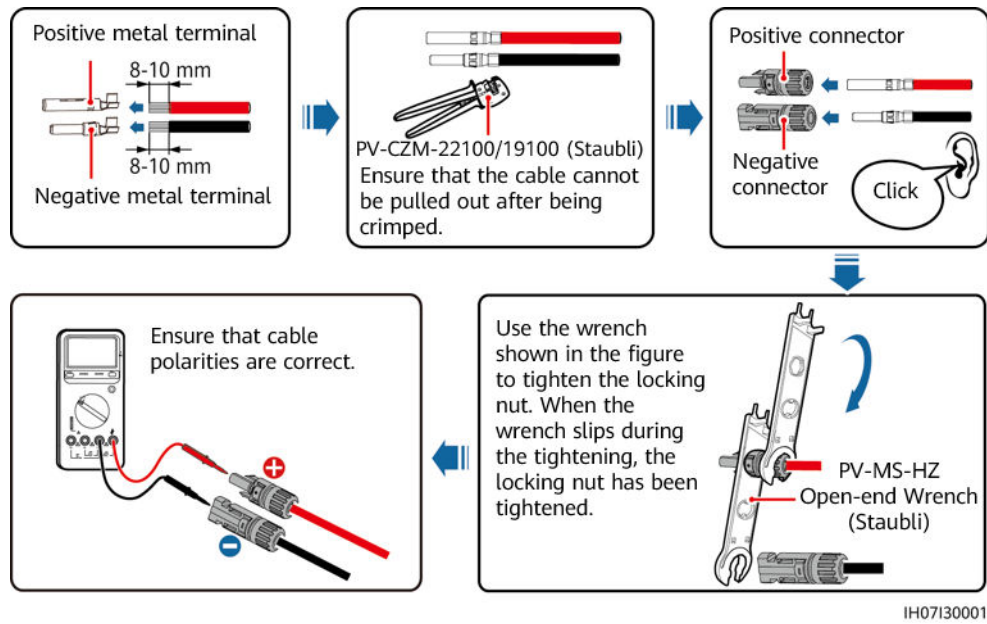
---

**NOTICE**

During DC input power cabling, leave at least 50 mm of slack. The axial tension on PV connectors must not exceed 80 N. Radial stress or torque must not be generated on PV connectors.

---

**Figure 5-13** Assembling DC connectors



----End

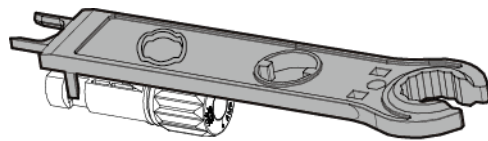
## Removing a DC Connector

**WARNING**

Before removing the positive and negative connectors, ensure that the DC SWITCH is set to OFF and that the current is less than 0.5 A.

To remove the positive and negative connectors from the inverter, insert an open-end wrench into the notch and press the wrench with an appropriate force.

**Figure 5-14** Removing a DC connector



IH07H00019



## 5.5 (Optional) Connecting Battery Cables

### Prerequisites

---

** DANGER**

- Battery short circuits may cause personal injury. The high transient current generated by a short circuit may release a surge of power and cause fire.
- Do not connect, disconnect, or perform other maintenance operations on battery cables when the inverter is running. Otherwise, electric shocks may occur.
- Before connecting the battery cables, ensure that the **DC SWITCH** on the inverter and all the switches connecting to the inverter are **OFF**, and that the inverter has no residual electricity. Otherwise, the high voltage of the inverter and battery may result in electric shocks.
- If no battery connects to the inverter, do not remove the waterproof covers from the battery terminals. Otherwise, the ingress protection (IP) rating of the inverter will be affected. If a battery connects to the inverter, keep the waterproof covers properly and reinstall them immediately after removing the connectors.

---

A battery switch can be configured between the inverter and the battery to ensure that the inverter can be safely disconnected from the battery.

---

** WARNING**

- Do not connect loads between the inverter and the battery.
- Ensure that the battery cables are connected to the battery terminals of the inverter. If a battery cable is connected incorrectly to the DC input terminal of the inverter, the inverter may be damaged or even a fire may occur.
- The battery cables must be connected correctly. That is, the positive and negative terminals of the battery connect to the positive and negative battery terminals of the inverter, respectively. Otherwise, the inverter may be damaged or even a fire may occur.

---

**NOTICE**

- If power cables are not installed or routed as required during the installation of the inverter and the battery, the positive or negative terminal of the battery will be short-circuited to ground. In this case, an AC or DC short circuit may occur and damage the inverter. The resulting device damage is not covered by the product warranty.
  - The cabling distance between the battery and the inverter shall be less than or equal to 10 m. It is recommended that the cabling distance be less than 5 m.
-

## Procedure

- Step 1** Assemble the positive and negative connectors by referring to [5.4 Connecting DC Input Power Cables](#).

### **DANGER**

- The battery voltage will result in serious injury. Use dedicated insulation tools to connect cables.
- Ensure that cables are connected correctly between the terminals of the battery and the battery switch, and between the battery switch and the battery terminals of the inverter.

### **NOTICE**

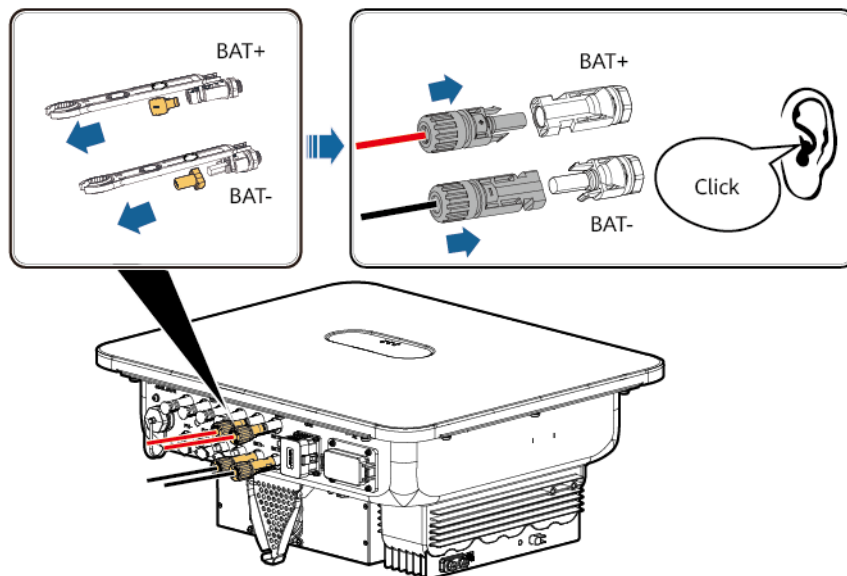
Cables with high rigidity, such as armored cables, are not recommended as battery cables, because poor contact may be caused by the bending of the cables.

- Step 2** Insert the positive and negative connectors into corresponding battery terminals of the inverter.

### **NOTICE**

After the positive and negative connectors snap into place, pull the battery cables back to ensure that they are connected securely.

**Figure 5-15** Connecting battery cables



IH08I30001

----End

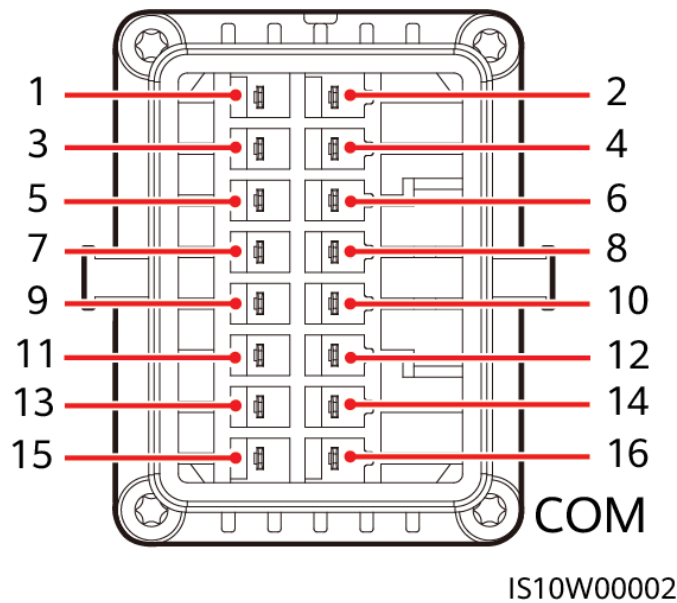
## 5.6 Connecting Signal Cables

### COM Port Pin Definitions

#### NOTICE

- When laying out a signal cable, separate it from power cables and keep it away from strong interference sources to prevent communication interruption.
- Ensure that the protection layer of the signal cable is inside the connector, surplus core wires are cut off from the protection layer, the exposed core wires are inserted completely into the holes, and the cable is connected securely.

Figure 5-16 Pin definitions



#### NOTE

- If the RS485 communications cables of devices, such as the Smart Power Sensor and battery, are connected to the inverter at the same time, RS485A2 (pin 7), RS485B2 (pin 9), and PE (pin 5) are shared.
- When the enabling signal cables of the battery and the rapid shutdown switch signal cables are connected to the inverter at the same time, GND (pin 13) is shared.

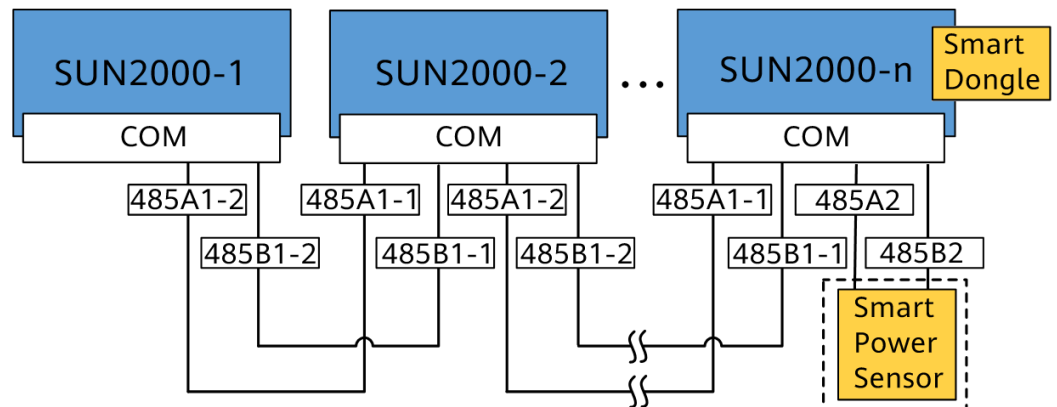
Pin	Definition	Function	Description	Pin	Definition	Function	Description
1	485A1-1	RS485A, RS485 differential signal+	For inverter cascading or connecting to the RS485 signal port of a SmartLogger or EMMA	2	485A1-2	RS485A, RS485 differential signal+	For inverter cascading or connecting to the RS485 signal port of a SmartLogger or EMMA
3	485B1-1	RS485B, RS485 differential signal-		4	485B1-2	RS485B, RS485 differential signal-	
5	PE	Shield layer grounding	-	6	PE	Shield layer grounding	-
7	485A2	RS485A, RS485 differential signal+	Connecting to RS485 signal ports of devices such as power meters and batteries	8	DIN1	Digital input signal 1+	Connecting to the power grid scheduling dry contact or receiving feedback signals of the on/off-grid controller
9	485B2	RS485B, RS485 differential signal-		10	DIN2	Digital input signal 2+	
11	EN	Enable signal	For the enable signal of the battery	12	DIN3	Digital input signal 3+	Connecting to the power grid scheduling dry contact
13	GND	GND	-	14	DIN4	Digital input signal 4+	

Pin	Definition	Function	Description	Pin	Definition	Function	Description
15	DIN5	Rapid shutdown	For the rapid shutdown DI signal or connecting to the signal cable of an NS protection device	16	GND	GND of DIN1, DIN2, DIN3, or DIN4	Connecting to GND of DIN1, DIN2, DIN3, or DIN4

### Communication Networking Mode

- Smart Dongle networking

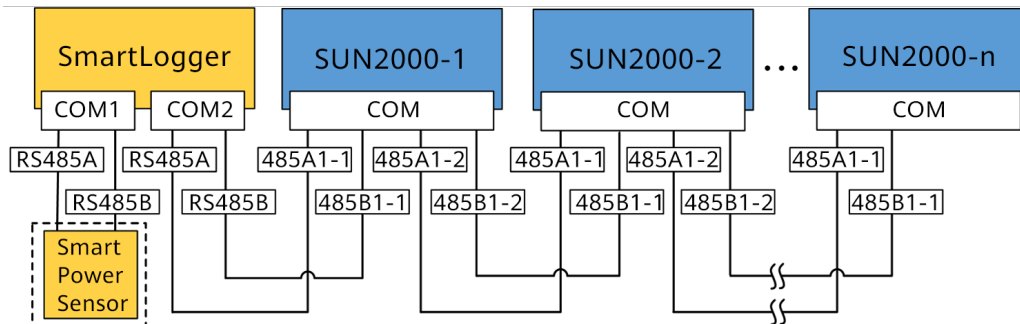
**Figure 5-17** Smart Dongle networking (the component in the dashed box is optional)



#### NOTE

- In the Smart Dongle networking scenario, the SmartLogger cannot be connected.
- A power meter is required for export limitation. Select a power meter based on the site requirements.
- The power meter and the Smart Dongle must be connected to the same inverter.
- In the Smart Dongle networking scenario, if a battery is equipped, inverters cannot be cascaded.
- SmartLogger networking

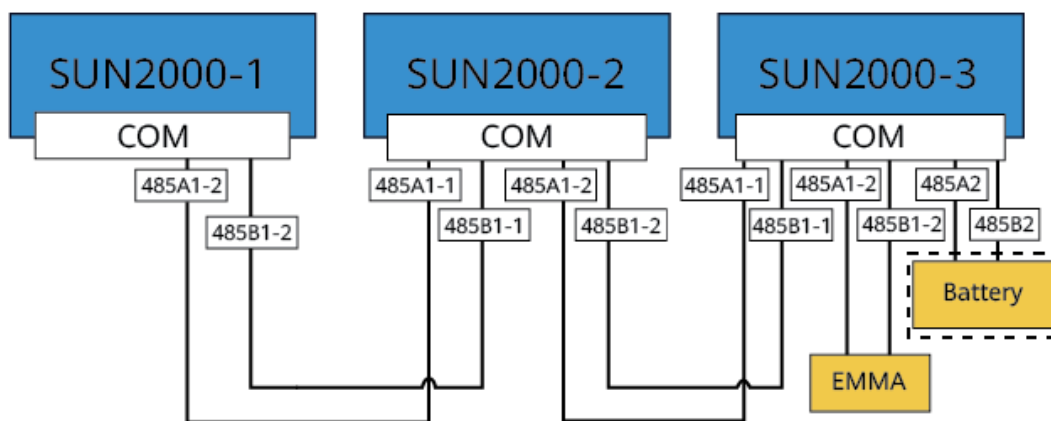
**Figure 5-18** SmartLogger networking (the component in the dashed box is optional)



**NOTE**

- A maximum of 80 devices can connect to a single SmartLogger. You are advised to connect fewer than 30 devices to each RS485 route.
- If the inverter is connected to the SmartLogger, it cannot be connected to the Smart Dongle.
- A power meter is required for export limitation. Select a power meter based on the site requirements.
- To ensure quick responses of the system, you are advised to connect the power meter separately to a COM port.
- If the inverter is connected to the SmartLogger, it cannot be connected to a battery.
- EMMA networking

**Figure 5-19** EMMA networking (the components in dashed boxes are optional)

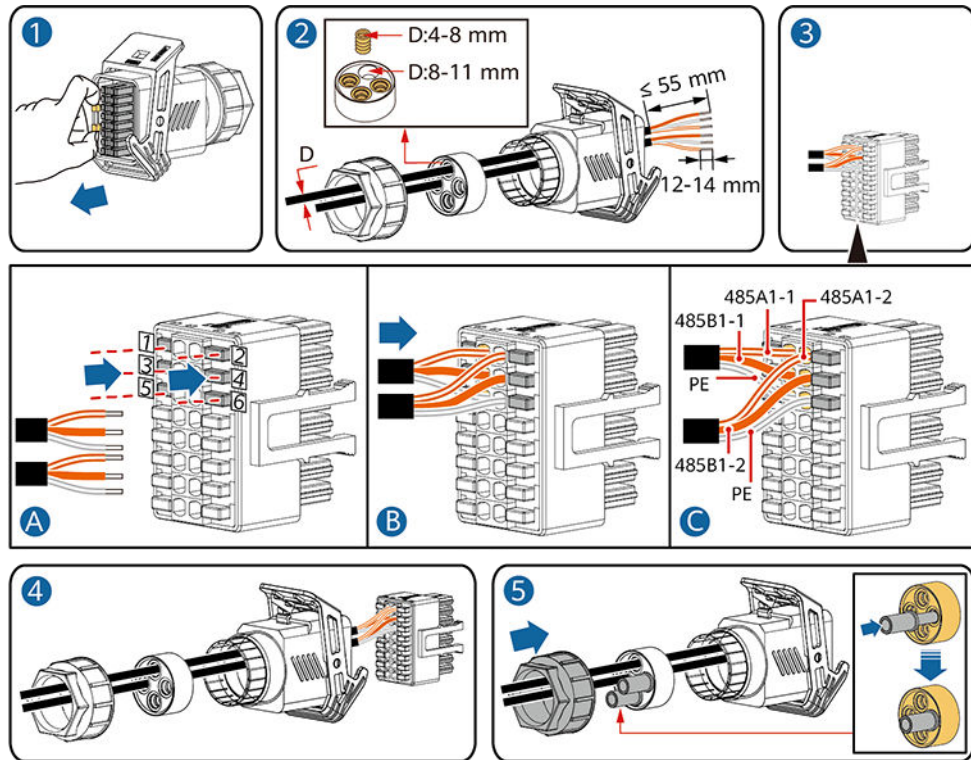


## 5.6.1 Connecting the RS485 Communications Cable (Inverter Cascading)

### Procedure

**Step 1** Connect the signal cable to the signal cable connector.

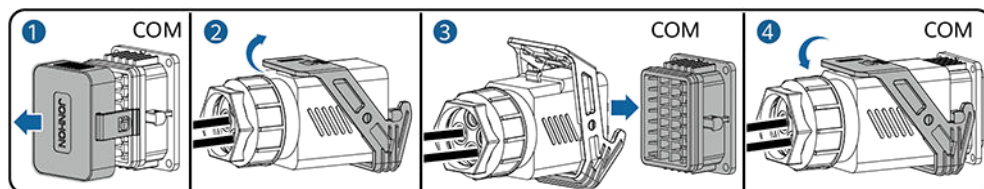
**Figure 5-20** Installing the cable



IS10120006

**Step 2** Connect the signal cable connector to the COM port.

**Figure 5-21** Securing the signal cable connector



IS10120007

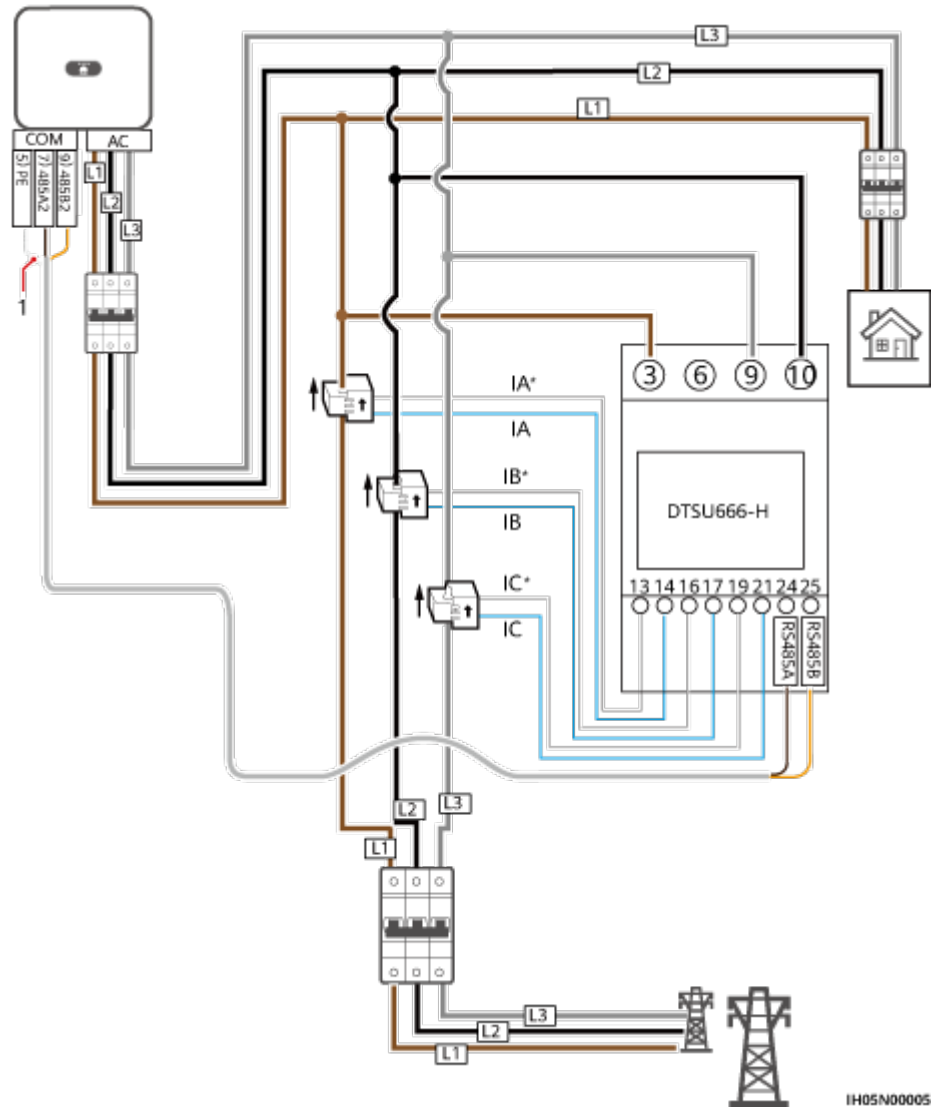
----End

## 5.6.2 Connecting RS485 Communications Cables (Power Meter)

### Cable Connections

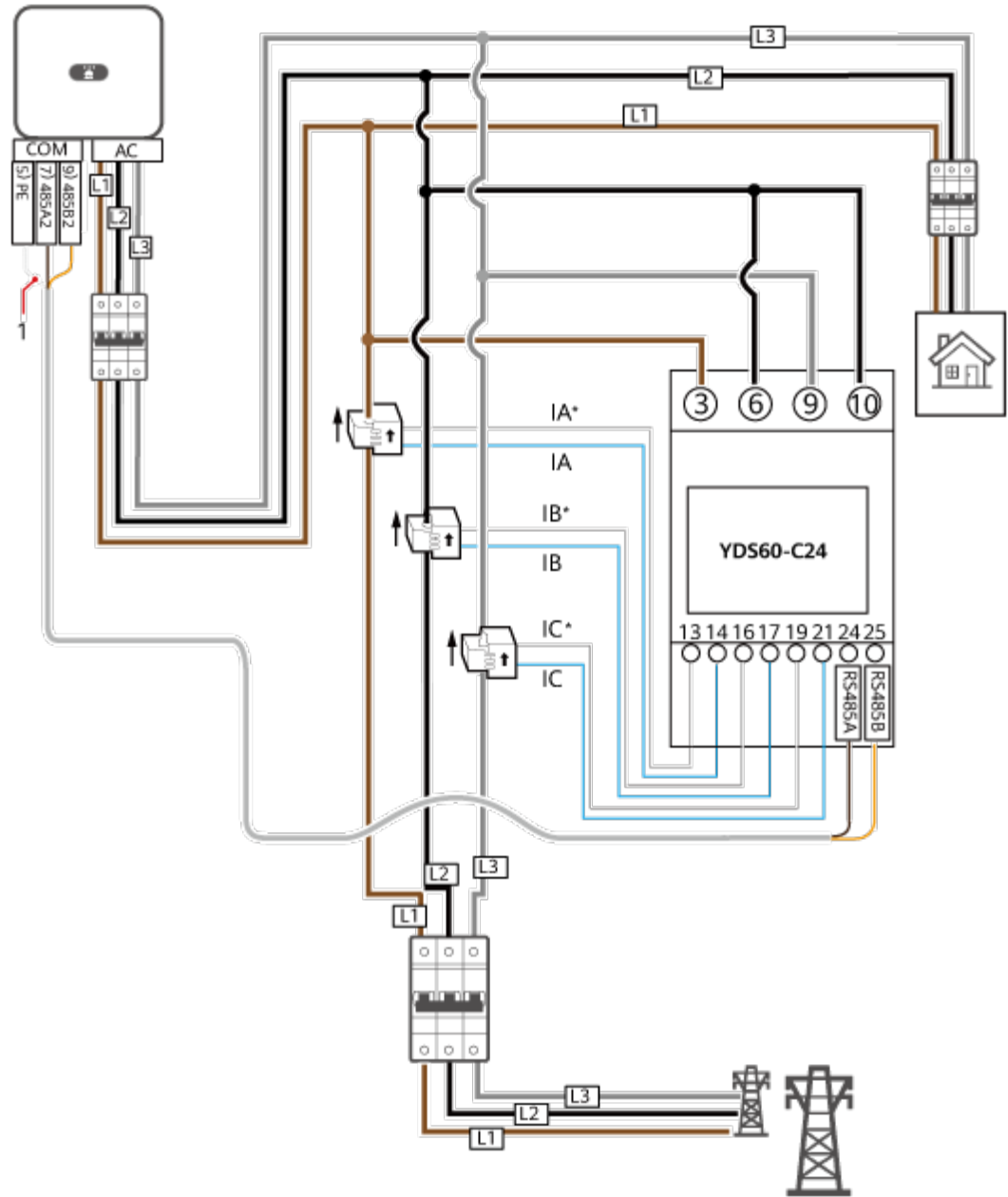
- The following figures show the cable connections between the inverter and DTSU666-H and YDS60-C24 power meters.

**Figure 5-22** DTSU666-H three-phase, three-wire cable connection (Smart Dongle networking)



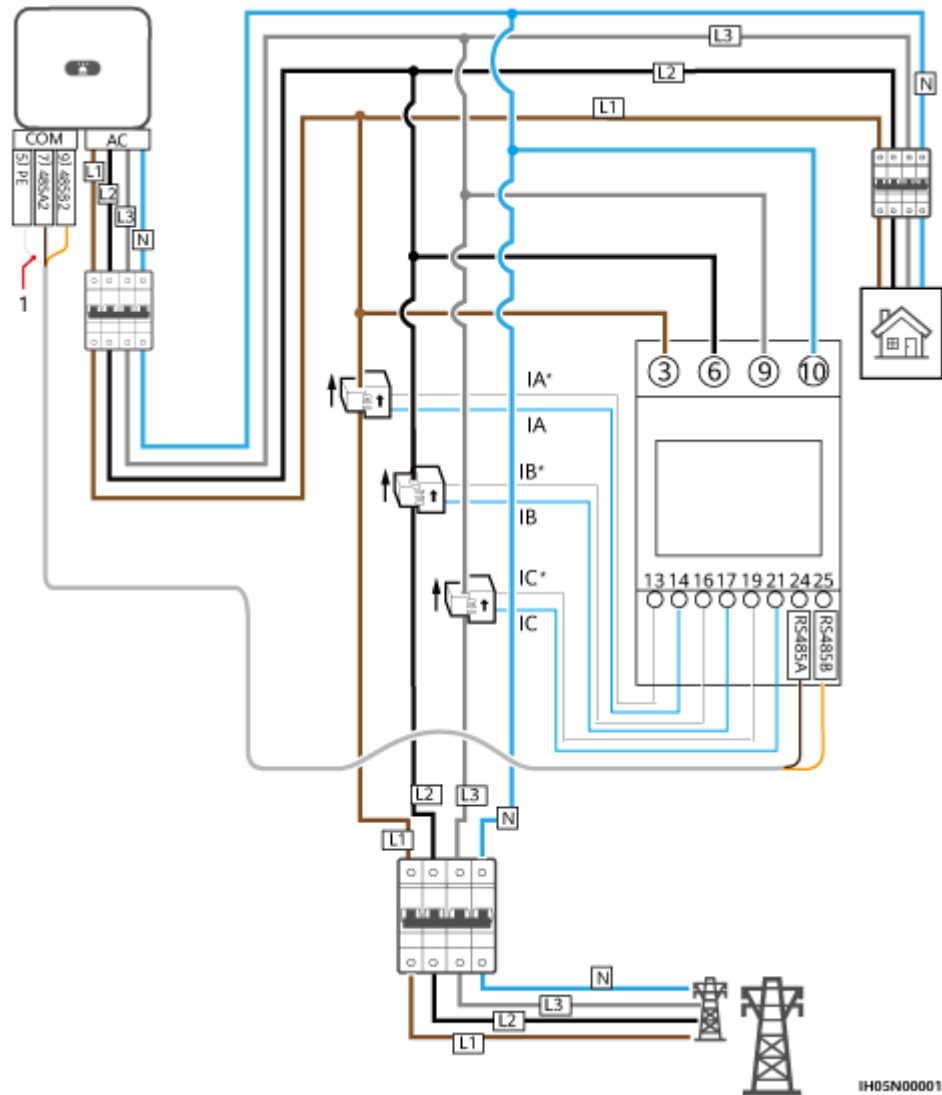


**Figure 5-23** YDS60-C24 three-phase, three-wire cable connection (Smart Dongle networking)



IH05N00006

**Figure 5-24** Three-phase, four-wire connection (Smart Dongle networking)



- The following figures show the cable connections between the inverter and DTSU666-HW and YDS60-80 power meters.

Figure 5-25 Three-phase, three-wire direct connection (Smart Dongle networking)

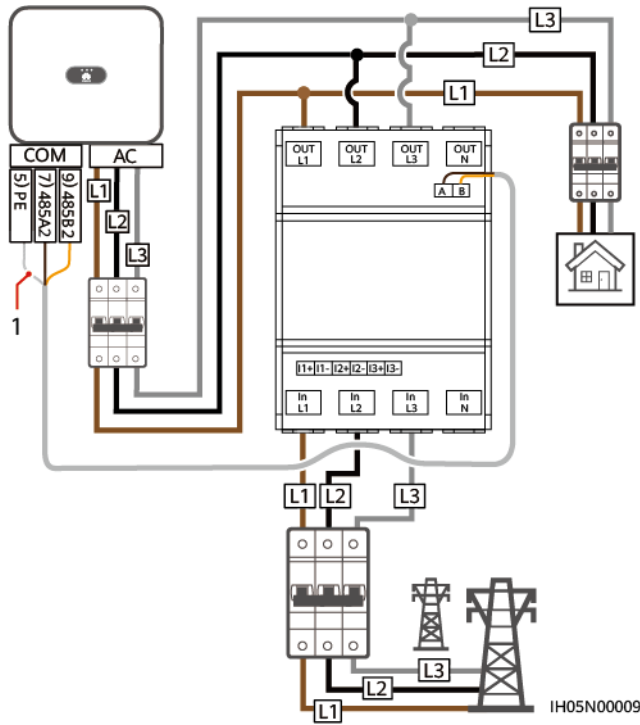
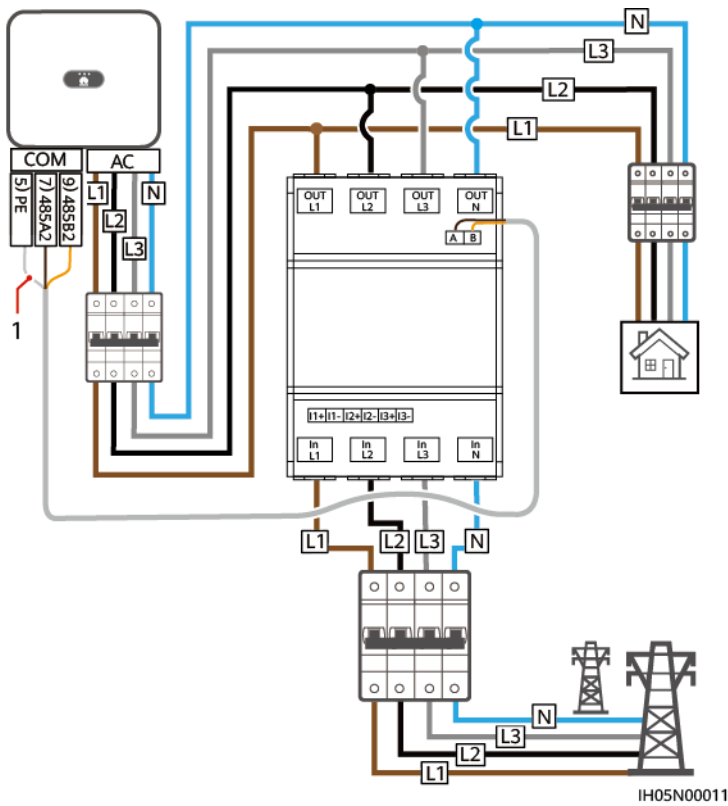
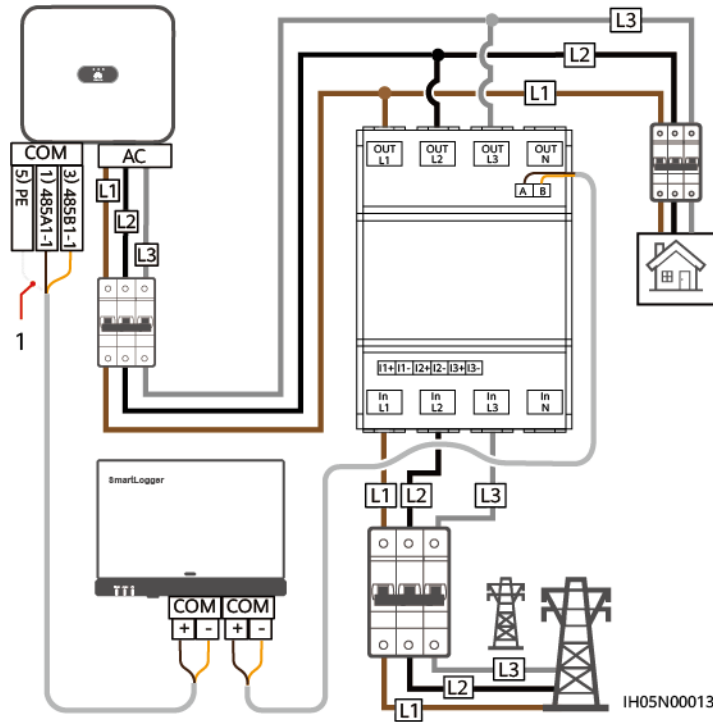


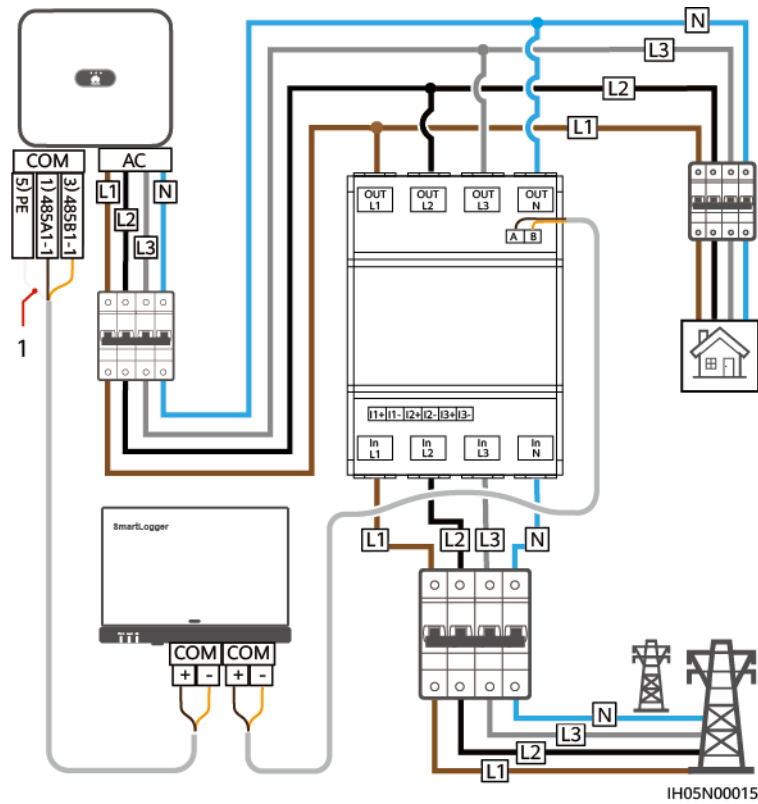
Figure 5-26 Three-phase, four-wire direct connection (Smart Dongle networking)



**Figure 5-27** Three-phase, three-wire direct connection (SmartLogger networking)



**Figure 5-28** Three-phase, four-wire direct connection (SmartLogger networking)



(1) Shield layer of the signal cable

**NOTE**

- The maximum current of the directly connected DTSU666-HW and YDS60-80 power meters is 80 A.
- For three-phase, three-wire connection, set the cable connection mode. Otherwise, the voltage reading is incorrect.
- Retain the default baud rates for the DTSU666-H and YDS60-C24 power meters. If they are changed, the power meters may go offline, generate alarms, or affect the inverter output power.

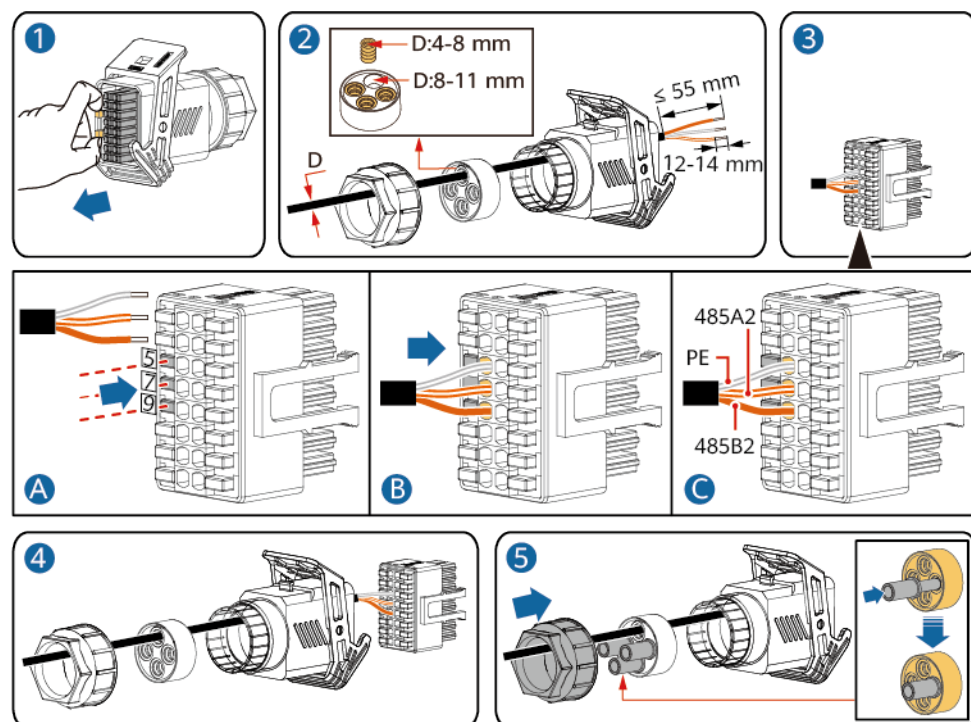
**Table 5-3** Setting the cable connection mode

Parameter	Description
nEE	Set the cable connection mode. <b>0:</b> n.34 indicates three-phase, four-wire (factory default). <b>1:</b> n.33 indicates three-phase, three-wire.

**Procedure**

**Step 1** Connect the signal cable to the signal cable connector.

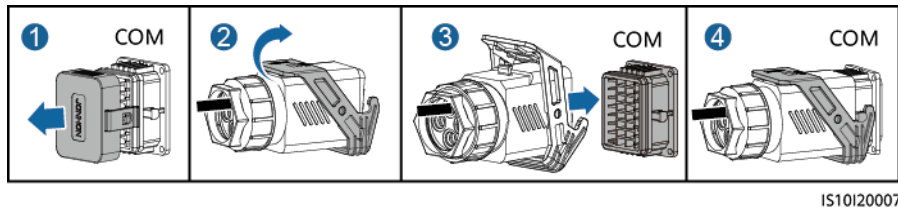
**Figure 5-29** Installing the cable



IS10120008

**Step 2** Connect the signal cable to the COM port.

Figure 5-30 Securing the signal cable connector



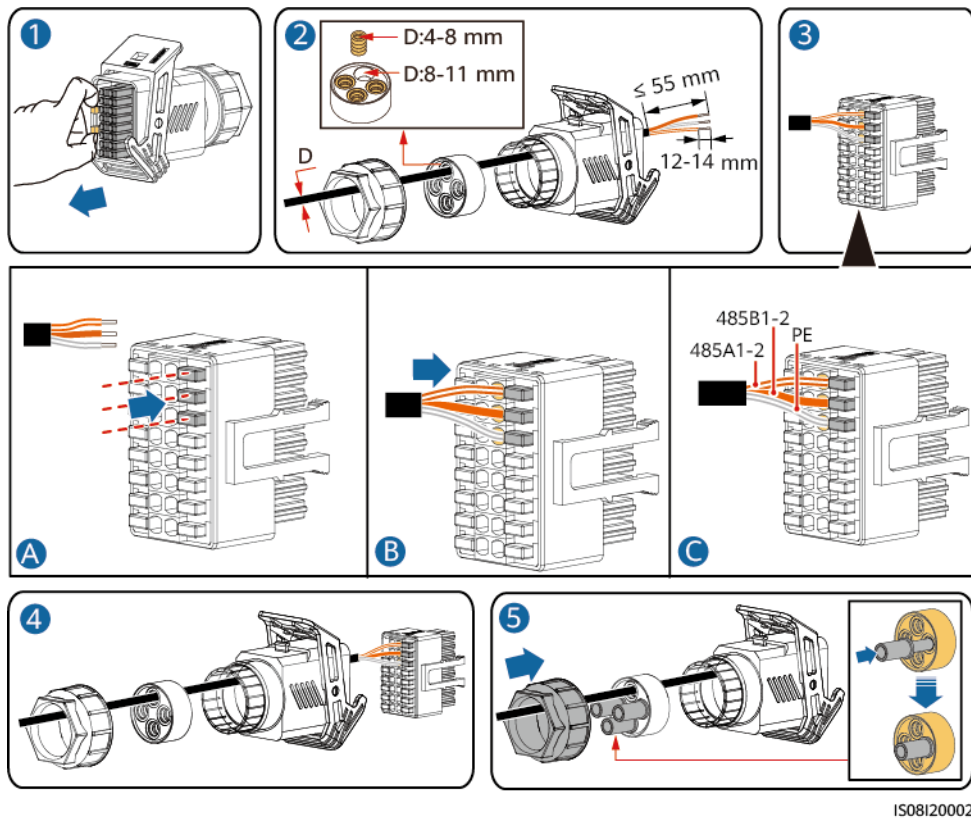
----End

## 5.6.3 Connecting RS485 Communications Cables (EMMA)

### Procedure

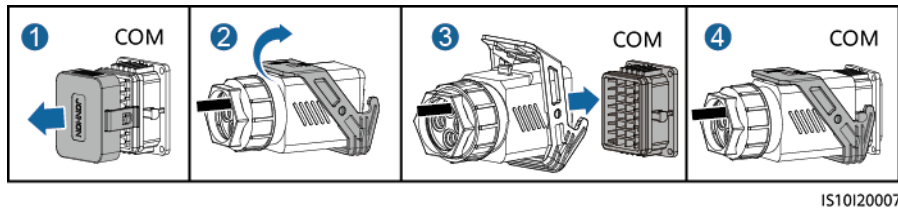
**Step 1** Connect the signal cable to the signal cable connector.

Figure 5-31 Installing the cable



**Step 2** Connect the signal cable connector to the COM port.

**Figure 5-32** Securing the signal cable connector



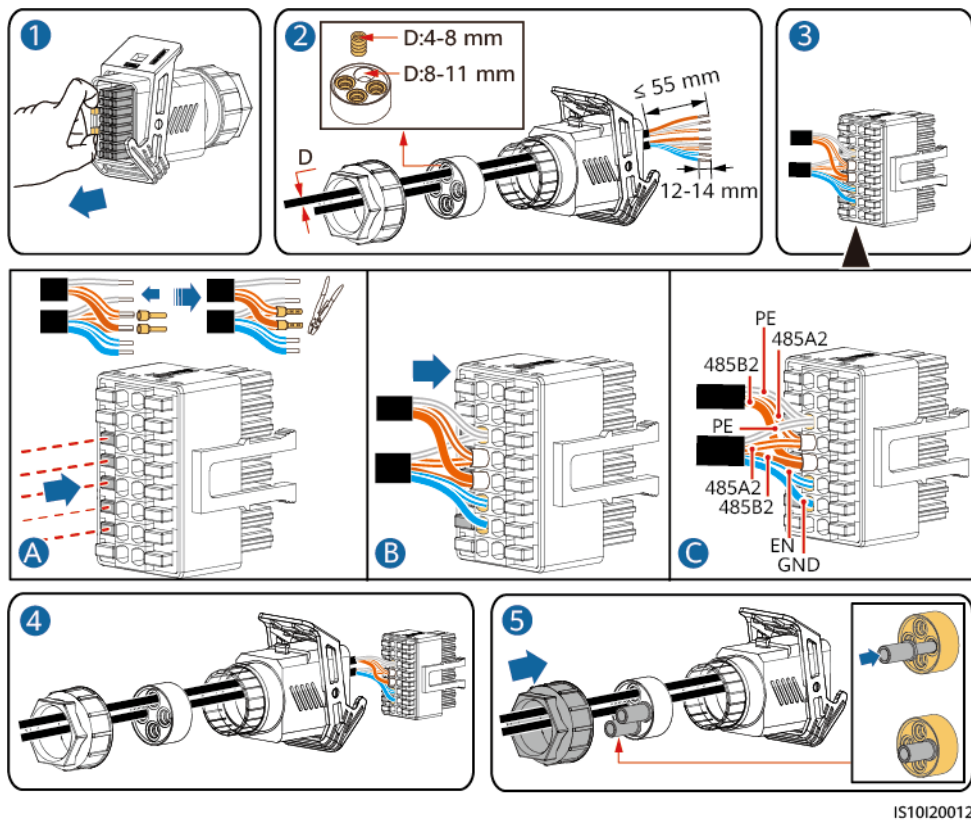
----End

## 5.6.4 Connecting RS485 Communications Cables (Power Meter and Battery)

### Procedure

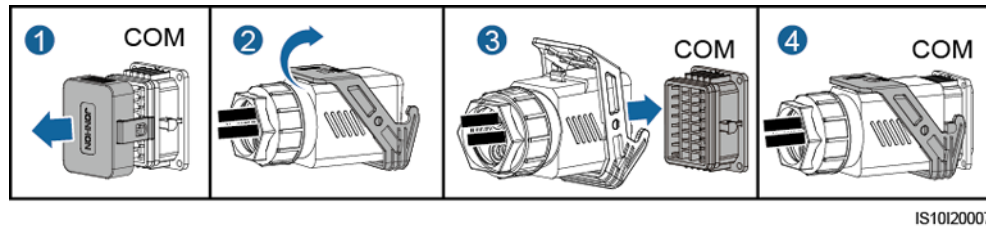
**Step 1** Connect signal cables to the signal cable connector.

**Figure 5-33** Installing cables



**Step 2** Connect the signal cable connector to the COM port.

Figure 5-34 Securing the signal cable connector



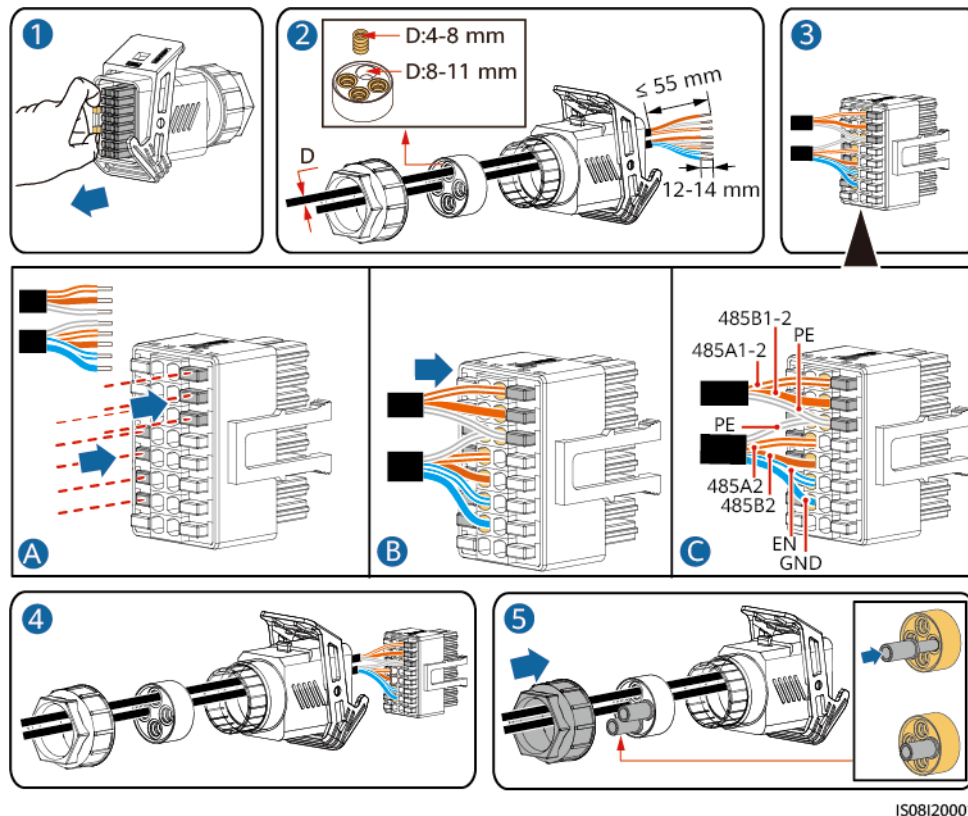
----End

## 5.6.5 Connecting RS485 Communications Cables (EMMA and Battery)

### Procedure

Step 1 Connect signal cables to the signal cable connector.

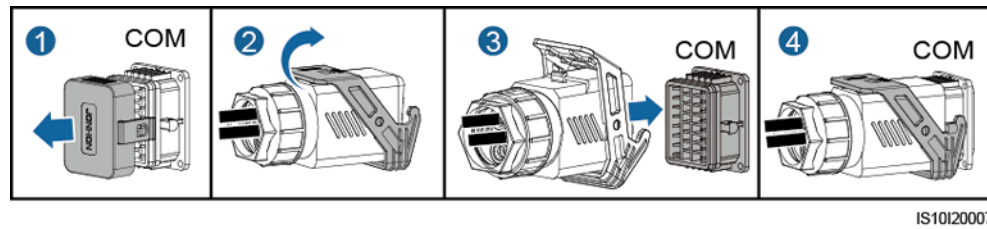
Figure 5-35 Installing cables



Step 2 Connect the signal cable connector to the COM port.



**Figure 5-36** Securing the signal cable connector



----End

## 5.6.6 Connecting the Rapid shutdown signal cable

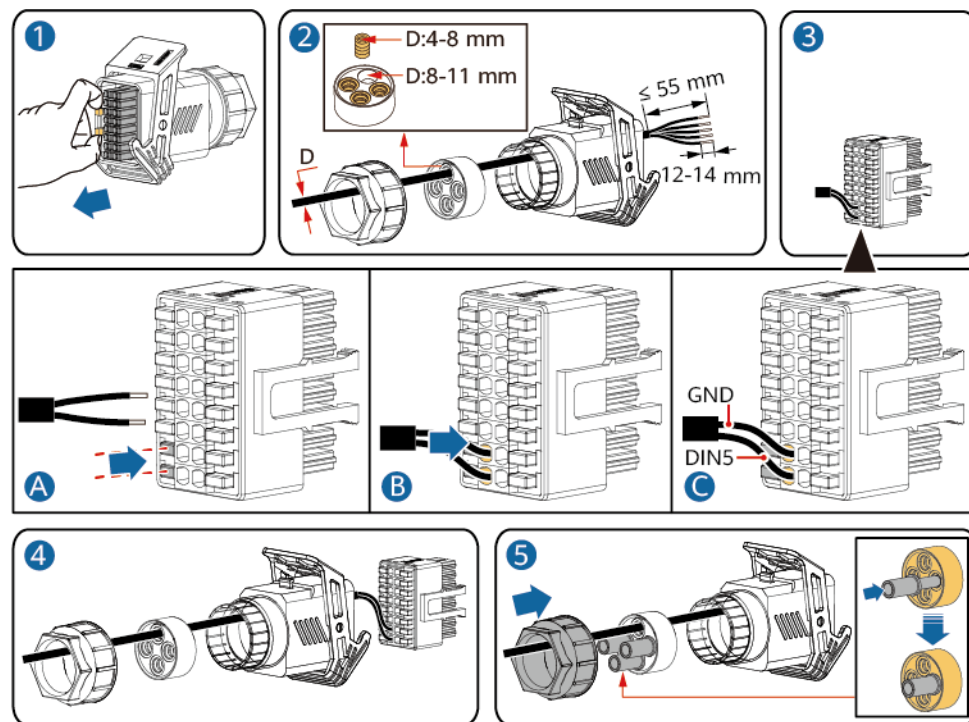
### Procedure

**Step 1** Connect the signal cable to the signal cable connector.

#### NOTICE

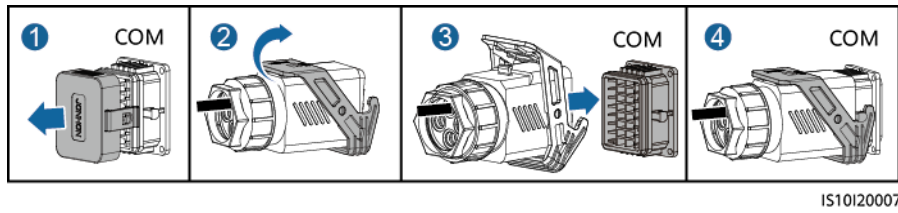
- If optimizers are configured for some PV modules, the rapid shutdown function is not supported.
- To enable the rapid shutdown function, you need to connect the access switch to pins 13 and 15. The switch is closed by default. The rapid shutdown is triggered when the switch changes from closed to open.

**Figure 5-37** Installing the cable



**Step 2** Connect the signal cable connector to the COM port.

**Figure 5-38** Securing the signal cable connector



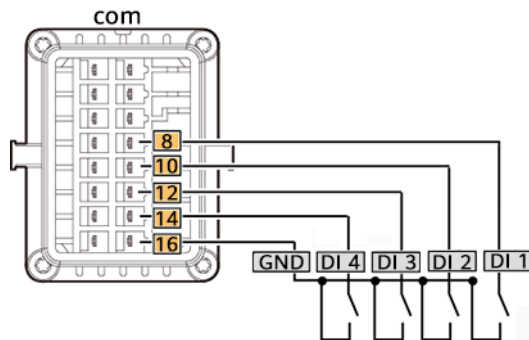
----End

## 5.6.7 Connecting the Power Grid Scheduling Signal Cable

### Cable Connection

The following figure shows the cable connections between the inverter and the Ripple Control Device.

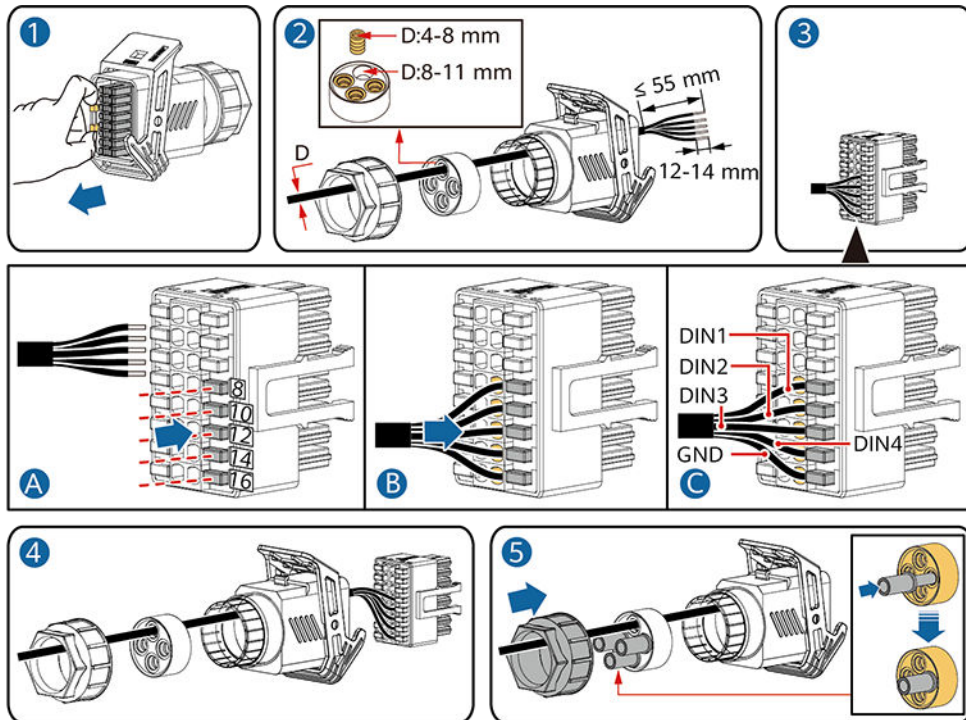
**Figure 5-39** Cable connection



### Procedure

**Step 1** Connect the signal cable to the signal cable connector.

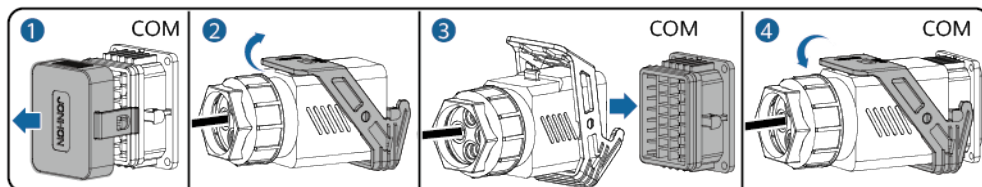
**Figure 5-40** Installing the cable



IS10I20010

**Step 2** Connect the signal cable to the COM port.

**Figure 5-41** Securing the signal cable connector



IS10I20007

----End

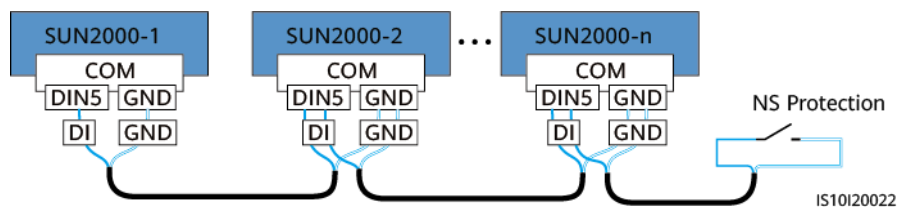
## 5.6.8 Connecting NS Protection Signal Cables

### Connecting NS Protection Signal Cables to Inverters

 NOTE

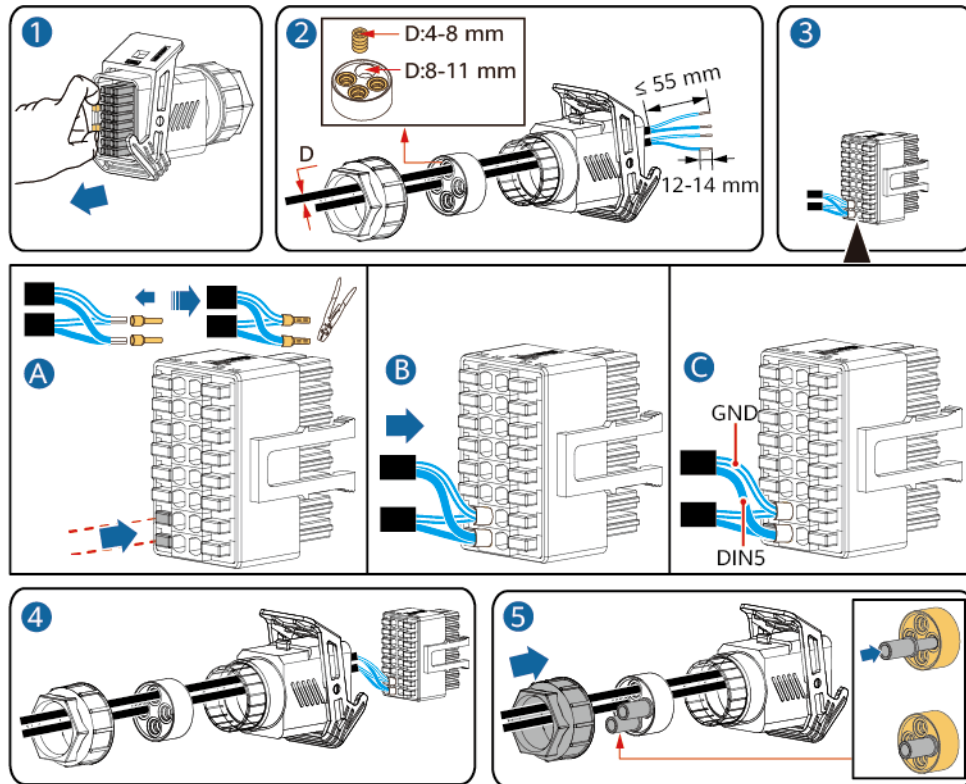
- The NS protection function is applicable to grid code **VDE-AR-N-4105**, **SWITZERLAND-NA/EEA:2020-LV230**, or **FINLAND-EN50549-LV230**.
- The NS protection switch is connected to GND (pin 1) at one end and to DIN5 (pin 6) at the other end. The switch is turned off by default. When the switch is turned on, NS protection is triggered. Rapid shutdown and NS protection use the same pins, which are GND (pin 1) and DIN5 (pin 6). Therefore, you can use only one of the functions.
- The NS protection switch connection is the same for a single inverter and for cascaded inverters.
- Log in to the FusionSolar app as an installer, choose **Me > Device commissioning**, and connect to the WLAN hotspot of the inverter. Log in to the local commissioning system as an installer, choose **Settings > Feature parameters > Dry contact function**, and set **Dry contact function** to **NS protection**.

**Figure 5-42** Connecting cascaded inverters to the NS protection switch



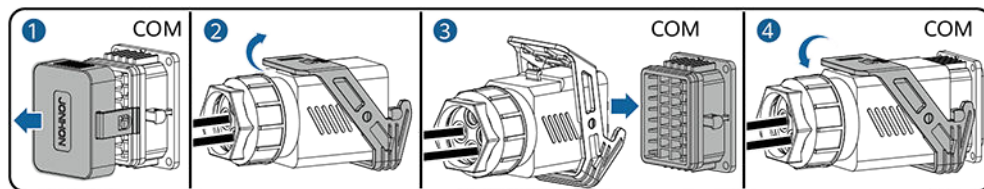
**Step 1** Connect signal cables to the signal cable connector (for inverter cascading).

**Figure 5-43** Installing cables



**Step 2** Connect the signal cable connector to the COM port.

**Figure 5-44** Securing the signal cable connector



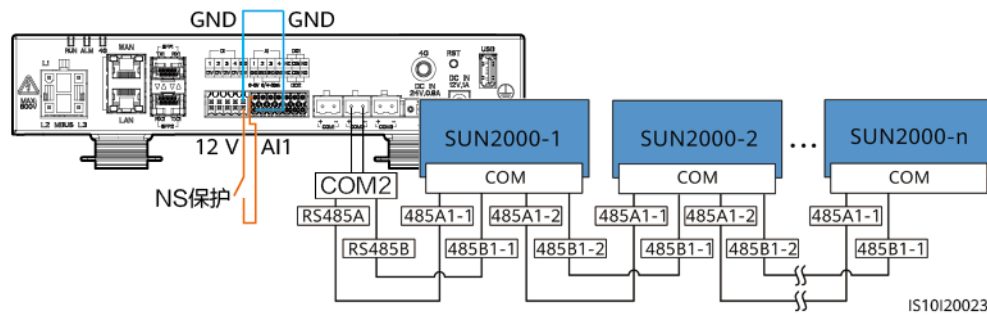
----End

## Connecting NS Protection Signal Cables to the SmartLogger

### NOTE

- The NS protection function is applicable to areas where standards such as VDE 4105 are used. You need to set the grid code to **VDE-AR-N-4105**, **SWITZERLAND-NA/EEA:2020-LV230**, or **FINLAND-EN50549-LV230**.
- The NS protection device is connected to the AI1 port and 12 V power output port on the SmartLogger. The SmartLogger shuts down the inverter over the voltage change detected at the AI1 port. When the NS protection device is disconnected, the voltage of the AI1 port is 0 V and the inverter shuts down. When the NS protection device is reconnected, the voltage of the AI1 port is 12 V and you need to manually start the inverter.

Figure 5-45 Connecting the SmartLogger to the NS protection switch



## 5.7 (Optional) Installing the Smart Dongle and Anti-theft Components

### NOTE

- If WLAN-FE communication is used, install the WLAN-FE Smart Dongle (SDongleA-05). For details, see [SDongleA-05 Smart Dongle Quick Guide \(WLAN-FE\)](#).
- If 4G communication is used, install the 4G Smart Dongle (SDongleB-06). For details, see [SDongleB-06 Smart Dongle Quick Guide \(4G\)](#).

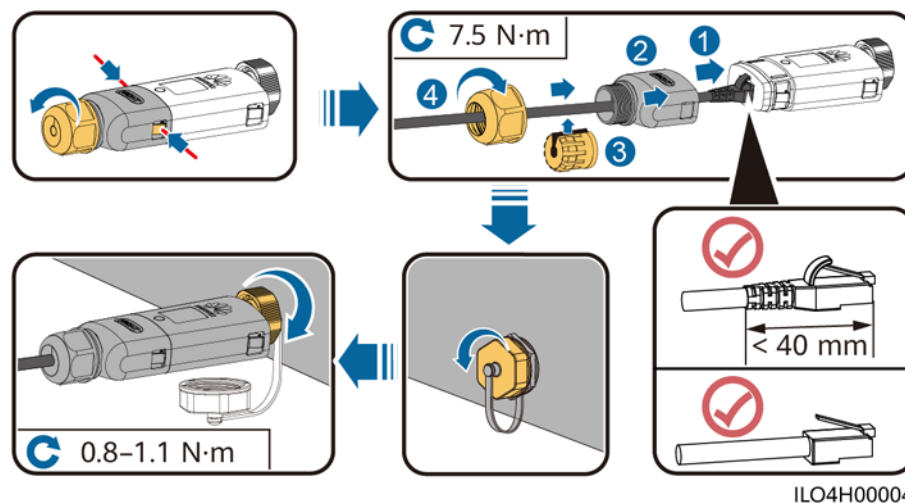
### NOTE

If the Smart Dongle is used, you need to install anti-theft components after installing the Smart Dongle.

### WLAN-FE Smart Dongle (FE Communication)

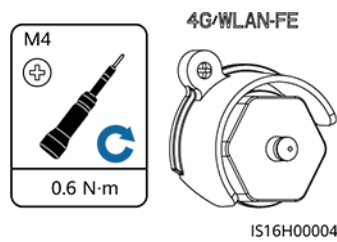
You are advised to use a CAT 5E outdoor shielded network cable (outer diameter < 9 mm; internal resistance  $\leq 1.5$  ohms/10 m) and shielded RJ45 connectors.

Figure 5-46 Installing a WLAN-FE Smart Dongle (FE communication)





**Figure 5-47** Installing anti-theft components for the Smart Dongle

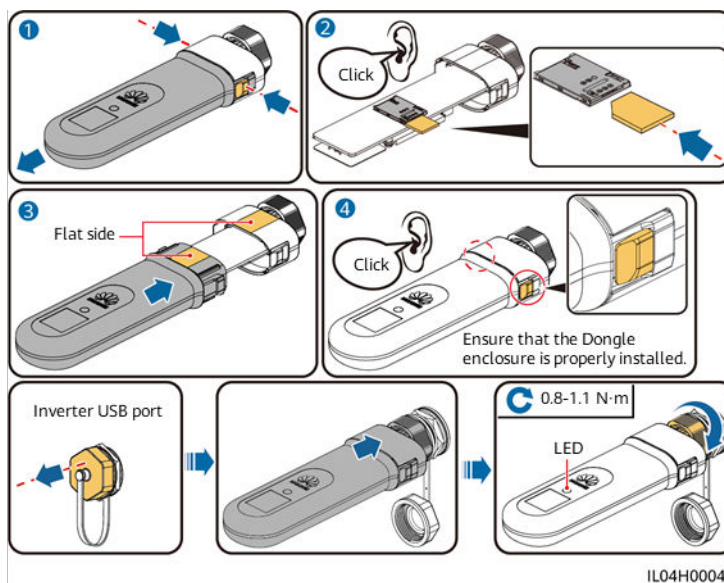


## 4G Smart Dongle (4G Communication)

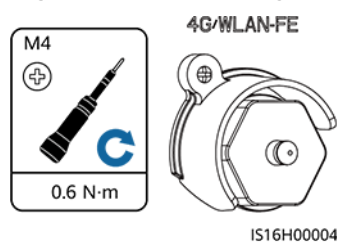
### NOTE

- If you prepared a Smart Dongle without a SIM card, you need to prepare a standard SIM card (size: 25 mm x 15 mm) with the capacity greater than or equal to 64 KB.
- When installing the SIM card, determine its installation direction based on the silk screen and arrow on the card slot.
- Press the SIM card in place to lock it, indicating that the SIM card is correctly installed.
- When removing the SIM card, push it inwards to eject it.
- When reinstalling the cover of the Smart Dongle, ensure that the buckles spring back in place with a click sound.

**Figure 5-48** Installing a 4G Smart Dongle (SDongleB-06)



**Figure 5-49** Installing anti-theft components for the Smart Dongle



# 6 Check Before Power-On

**Table 6-1** Installation checklist

No.	Check Item	Acceptance Criteria
1	SUN2000 installation	The SUN2000 is installed correctly, securely, and reliably.
2	Smart Dongle	The Smart Dongle is installed correctly and securely.
3	Cable layout	Cables are routed properly as required by the customer.
4	Cable tie	Cable ties are secured evenly and no burr exists.
5	Grounding	The ground cable is connected correctly, securely, and reliably.
6	Turn off the switches	The <b>DC SWITCH</b> and all the switches connected to the SUN2000 are set to <b>OFF</b> .
7	Cable connections	The AC output power cable, DC input power cable, and signal cable are connected correctly, securely, and reliably.
8	Unused terminals and ports	Unused terminals and ports are locked by watertight caps.
9	Installation environment	The installation space is proper, and the installation environment is clean and tidy, without foreign matter.



# 7 Power-On and Commissioning

---

---

## DANGER

- Wear personal protective equipment and use dedicated insulated tools to avoid electric shocks or short circuits.
- 

## 7.1 Powering On the Inverter

### Precautions

---

#### NOTICE

- Before the equipment is put into operation for the first time, ensure that the parameters are set correctly by professional personnel. Incorrect parameter settings may result in noncompliance with local grid connection requirements and affect the normal operations of the equipment.
  - If the DC power supply is connected but the AC power supply is disconnected, the inverter will report a **Grid Failure** alarm. The inverter can start properly only after the power grid recovers.
- 

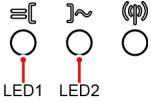
### Procedure

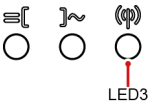
- Step 1** If a battery is connected, turn on the battery switch first.
- Step 2** At the AC switch between the inverter and the power grid, use a multimeter to measure the grid voltage and ensure that the voltage is within the allowed operating voltage range of the inverter. If the voltage is not in the allowed range, check the circuits.
- Step 3** Turn on the AC switch between the inverter and the power grid.
- Step 4** Turn on the DC switch (if any) between the PV strings and the inverter.
- Step 5** (Optional) Remove the knob locking screw next to the DC SWITCH on the inverter.

**Step 6** Set the DC SWITCH on the inverter to ON.

**Step 7** Observe the LED indicators to check the status of the inverter.

**Table 7-1** LED indicator description

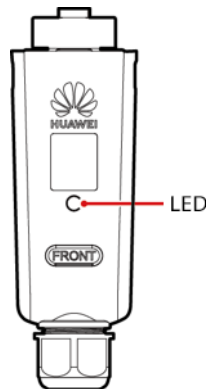
Category	Status		Description
Running indication 	<b>LED1</b>	<b>LED2</b>	-
	Steady green	Steady green	The inverter is operating in grid-tied mode.
	Blinking green slowly (on for 1s and off for 1s)	Off	The DC is on and the AC is off.
	Blinking green slowly (on for 1s and off for 1s)	Blinking green slowly (on for 1s and off for 1s)	Both the DC and AC are on, and the inverter is off-grid.
	Off	Blinking green slowly (on for 1s and off for 1s)	The DC is off and the AC is on.
	Off	Off	Both the DC and AC are off.
	Blinking red fast (on for 0.2s and off for 0.2s)	-	There is a DC environmental alarm, such as <b>High String Input Voltage, String Reverse Connection, or Low Insulation Resistance.</b>
	-	Blinking red fast	There is an AC environmental alarm, such as <b>Grid Undervoltage, Grid Overvoltage, Grid Overfrequency, or Grid Underfrequency.</b>
	Steady red	Steady red	A fault exists.

Category	Status	Description		
Communica tion indication 	<b>LED3</b>	-		
	Blinking green fast (on for 0.2s and off for 0.2s)	Communication is in progress. (When a mobile phone is connected to the inverter, the indicator first blinks green slowly, indicating that the phone is connected to the inverter.)		
	Blinking green slowly (on for 1s and off for 1s)	The mobile phone is connected to the inverter.		
	Off	There is no communication.		
Device replacement indication	<b>LED1</b>	<b>LED2</b>	<b>LED3</b>	-
	Steady red	Steady red	Steady red	The inverter hardware is faulty and needs to be replaced.

**Step 8** (Optional) Observe the Smart Dongle LED indicator to check the status of the Smart Dongle.

- WLAN-FE Smart Dongle

**Figure 7-1** WLAN-FE Smart Dongle



**Table 7-2** Indicator description

LED Indicator	Status	Remarks	Description
-	Off	Normal	The Smart Dongle is not secured or not powered on.

LED Indicator	Status	Remarks	Description
Yellow (blinking green and red simultaneously)	Steady on		The Smart Dongle is secured and powered on.
Red	Blinking fast (on for 0.2s and off for 0.2s)		The parameters for connecting to the router are to be set.
Red	Steady on	Abnormal	The Smart Dongle is faulty and needs to be replaced.
Blinking red and green alternately	Blinking slowly (on for 1s and off for 1s)	Abnormal	No communication with the inverter: - Remove and then insert the Smart Dongle. - Check whether the inverter matches the Smart Dongle. - Connect the Smart Dongle to another inverter. Check whether the Smart Dongle is faulty or the USB port of the inverter is faulty.
Green	Blinking slowly (on for 0.5s and off for 0.5s)	Normal	Connecting to the router
Green	Steady on		The management system is successfully connected.
Green	Blinking fast (on for 0.2s and off for 0.2s)		The inverter is communicating with the management system through the Smart Dongle.

- 4G Smart Dongle

**Table 7-3** Indicator description

LED Indicator	Status	Remarks	Description
-	Off	Normal	The Smart Dongle is not secured or not powered on.

LED Indicator	Status	Remarks	Description
Yellow (blinking green and red simultaneously)	Steady on	Normal	The Smart Dongle is secured and powered on.
Green	The blinking interval is 2s. The indicator is on for 0.1s and off for 1.9s.	Normal	Dialing (lasts for less than 1 minute)
		Abnormal	If the duration is longer than 1 minute, the 4G parameter settings are incorrect. Re-configure the parameters.
	Blinking slowly (on for 1s and off for 1s)	Normal	The dialup is successful (lasts for less than 30s).
		Abnormal	If the duration is longer than 30s, the management system parameters are incorrectly set. Re-configure the parameters.
	Steady on	Normal	The management system is successfully connected.
Blinking fast (on for 0.2s and off for 0.2s)	The inverter is communicating with the management system through the Smart Dongle.		
Red	Steady on	Abnormal	The Smart Dongle is faulty and needs to be replaced.
	Blinking fast (on for 0.2s and off for 0.2s)		The Smart Dongle has no SIM card or the SIM card is in poor contact. Check whether the SIM card has been installed or is in good contact. If not, install a SIM card or remove and re-insert the SIM card.

LED Indicator	Status	Remarks	Description
	Blinking slowly (on for 1s and off for 1s)		The Smart Dongle fails to be connected to a management system because the SIM card has poor or no reception, or has run out of mobile data. If the Smart Dongle is reliably connected, check the SIM card connectivity through the app. If you have poor or no reception, contact the carrier. Check whether the tariff and mobile data plan of the SIM card are adequate. If not, ensure sufficient balance in the SIM card or purchase a data package.
Blinking red and green alternately	Blinking slowly (on for 1s and off for 1s)		No communication with the inverter: <ul style="list-style-type: none"> <li>– Remove and then insert the Smart Dongle.</li> <li>– Check whether the inverter matches the Smart Dongle.</li> <li>– Connect the Smart Dongle to another inverter.</li> </ul> Check whether the Smart Dongle is faulty or the USB port of the inverter is faulty.

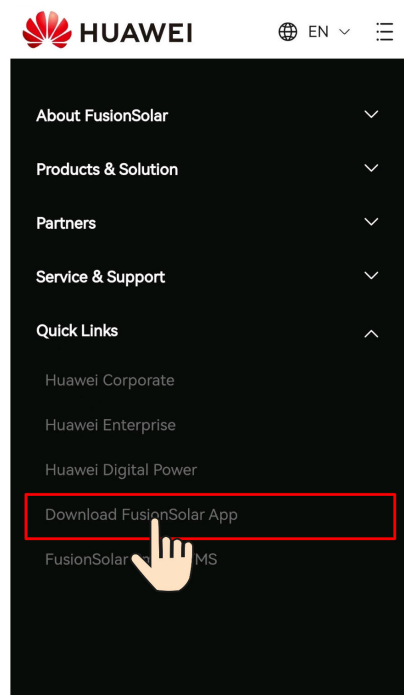
----End

## 7.2 Creating a Plant

### 7.2.1 Downloading the FusionSolar App

- Method 1: Access <https://solar.huawei.com> using the mobile phone browser and download the latest installation package.

Figure 7-2 Downloading the app



- Method 2: Search for **FusionSolar** on Huawei AppGallery and download the latest installation package.
- Method 3: Scan the QR code and download the latest installation package.

Figure 7-3 QR code



FusionSolar

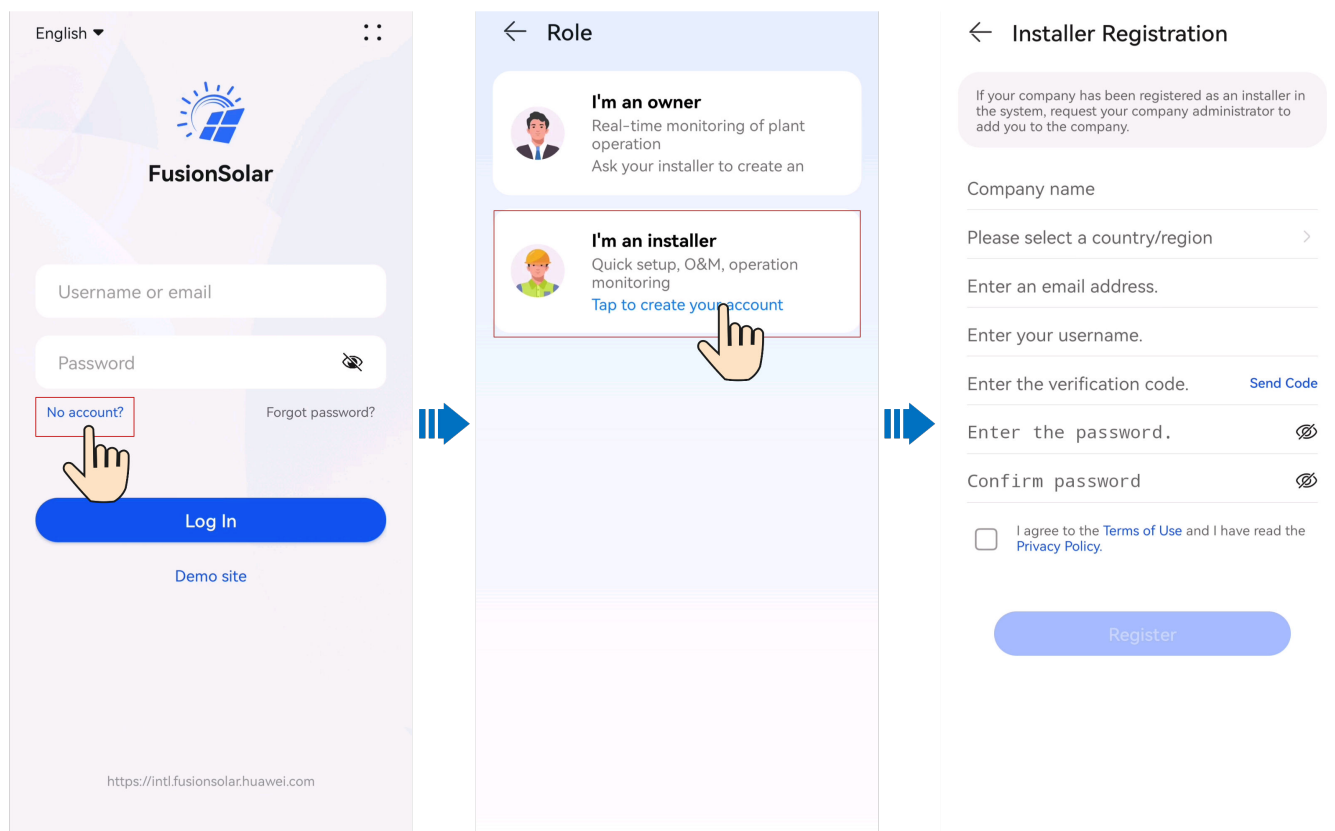
## 7.2.2 (Optional) Registering an Installer Account

### NOTE

- If you have an installer account, skip this step.
- You can register an account only using a mobile phone only in China.
- The mobile number or email address used for registration is the user name for logging in to the FusionSolar App.

Create the first installer account and create a domain named after the company name.

Figure 7-4 Creating the first installer account

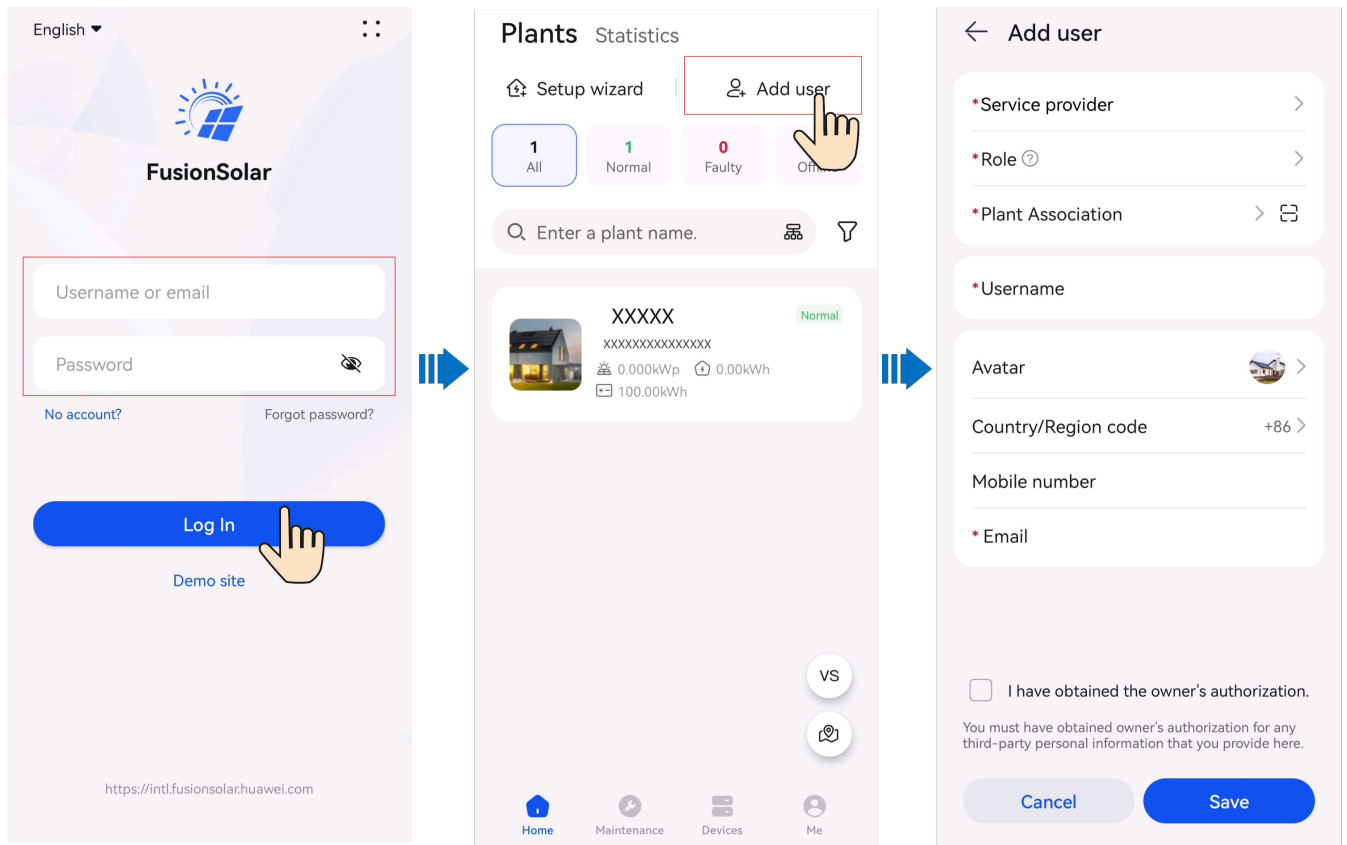


### NOTICE

To create multiple installer accounts for a company, log in to the FusionSolar App and tap **Add User** to create an installer account.

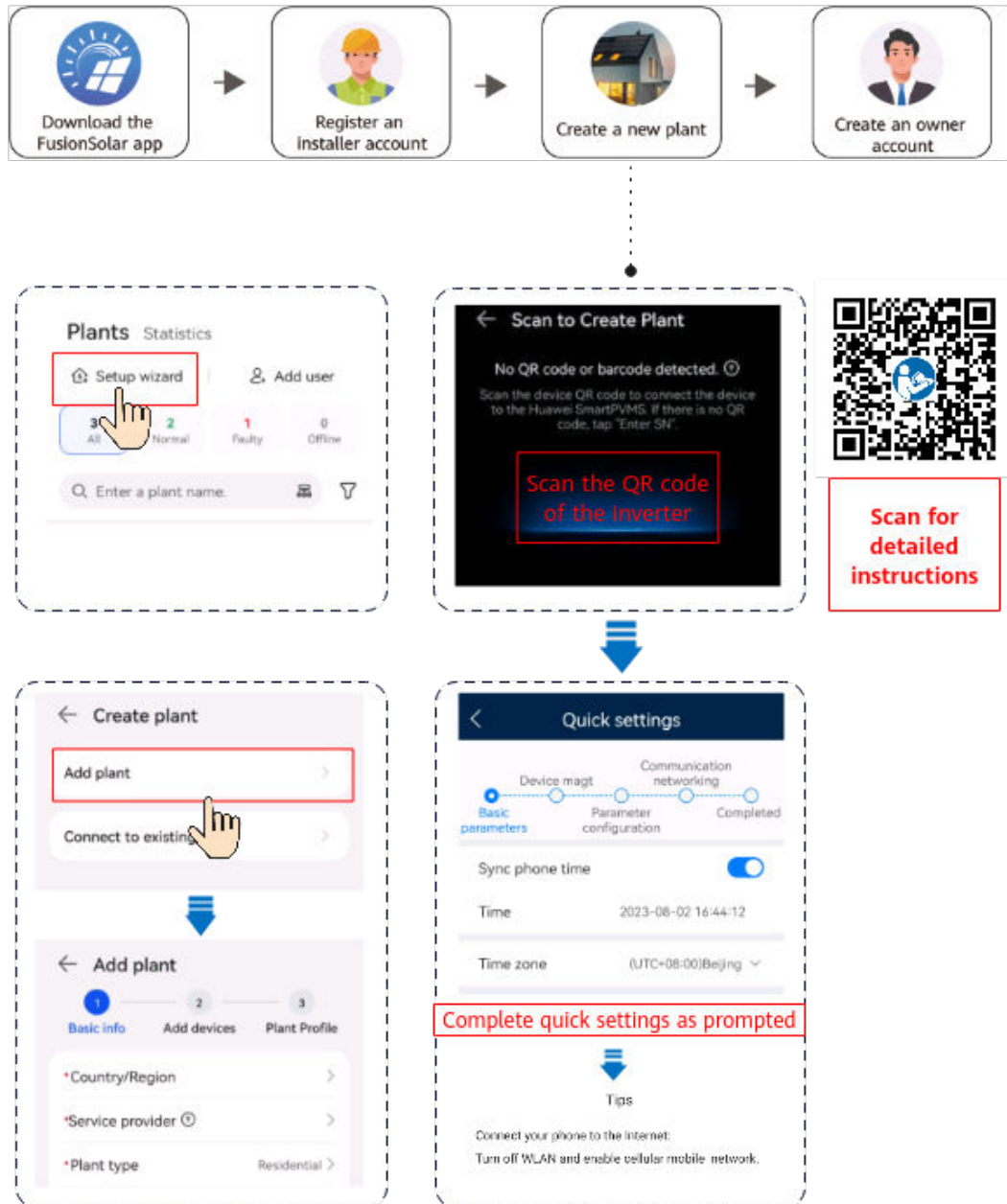


Figure 7-5 Creating multiple installer accounts for the same company



## 7.2.3 Deploying a New Plant

### Smart Dongle Networking



#### NOTE

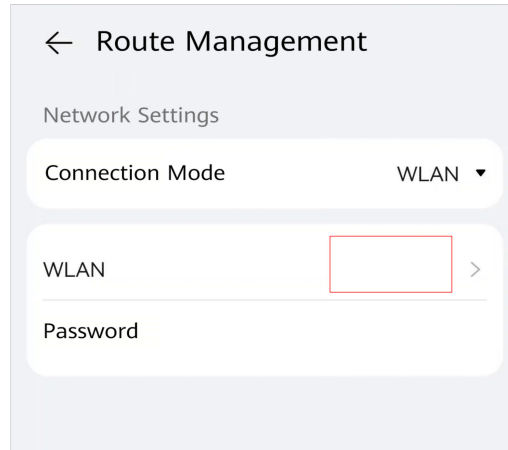
For details about new plant deployment, see the [FusionSolar App Quick Guide](#) or scan the QR code.

## EMMA Networking



 NOTE

For details about new plant deployment, see the [FusionSolar App Quick Guide \(EMMA\)](#).  
If the charger connects to the router through WiFi, you need to log in to the charger to set the WiFi information before deploying the EMMA.



## 7.3 Commissioning Functions and Features

### NOTICE

- The grid-connection voltage and frequency of inverters in China are set before delivery according to NB/T 32004 or the latest Chinese standard. If the inverter fails to connect to the power grid because the power grid voltage is close to or higher than the voltage required by Chinese laws and regulations, you can select other voltage level after obtaining permission from the local power operator.
- If the power grid voltage exceeds the upper threshold, the service life of loads on the grid side may be affected, or energy yield loss may occur. In this case, the Company will not be liable for any consequences.

Choose **Commission Device** and set related device parameters.

- For details about the commissioning portal when the Smart Dongle networking is used, see [B Connecting to the Inverter](#).
- For details about the commissioning portal when the EMMA networking is used, see [C Connecting to the EMMA](#).

### 7.3.1 Setting Common Parameters

Set common parameters based on the devices connected to the plant.

**Table 7-4** Setting common parameters

Parameter	Scenario Description	Operation
Grid-tied point control	Many regions impose a limit on the feed-in power of a power generation system. Therefore, a power meter is required to measure the power of the grid-tied point to control the output of the inverter in real time, ensuring that the feed-in power meets the power requirement allowed by the power grid.	<ul style="list-style-type: none"> <li>Smart Dongle networking: Choose <b>Commission Device</b>, tap <b>Power adjustment</b>, and set related parameters. For details about the parameter description and settings, see the section about <b>Parameter Settings</b> in the <a href="#">Residential Smart PV Solution Commissioning Manual (Smart Dongle)</a>.</li> <li>EMMA networking: Choose <b>Commission Device</b>, tap <b>Power adjustment</b>, and set related parameters. For details about the parameter description and settings, see the section about <b>Parameter Settings</b> in the <a href="#">Residential Smart PV Solution User Manual (EMMA)</a>.</li> </ul>
Battery parameter setting	If a battery is connected to the system, you need to add the battery and set battery parameters.	
Capacity control	This function applies to areas that have peak demand charges. The capacity control function allows you to lower the peak power drawn from grid in maximum self-consumption or TOU mode during peak hours, reducing electricity fees.	

To set more parameters, tap **Settings**. For details about the parameter settings, see the [FusionSolar App User Manual](#). You can also scan the QR code to obtain the document.



### 7.3.2 (Optional) Setting the Physical Layout of the Smart PV Optimizers

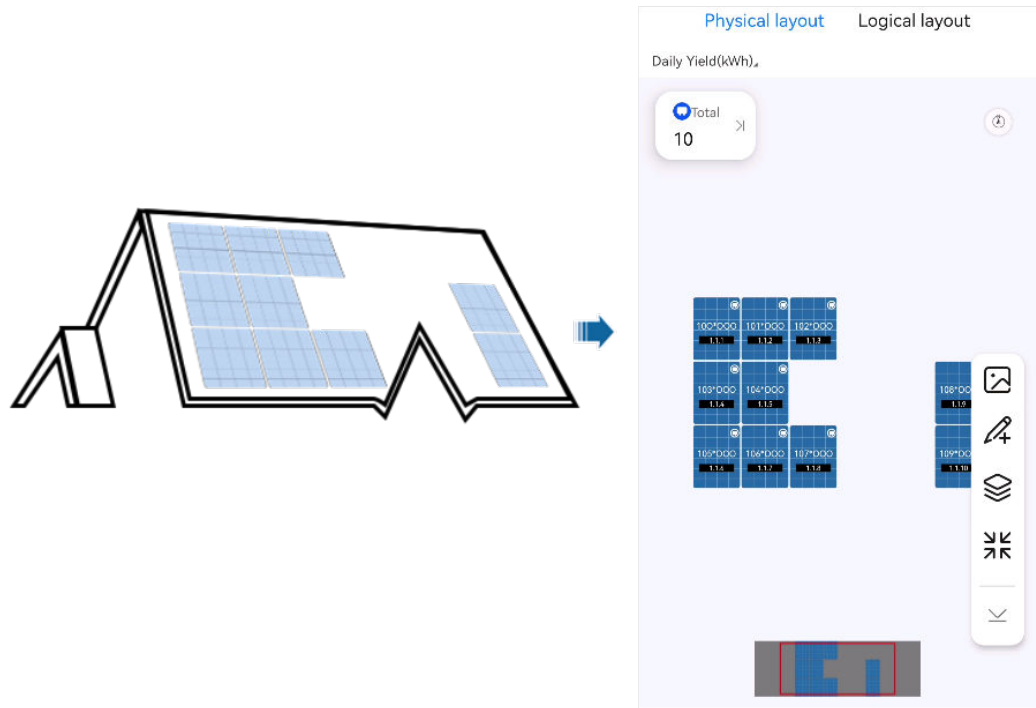
The Smart PV Optimizer is a DC to DC converter which implements maximum power point tracking (MPPT) of each PV module to improve the energy yield of the PV system. It enables module-level shutdown and monitoring.

If optimizers are configured for PV modules, you can view the physical location of each optimizer after creating a physical layout. If a PV module is faulty, you can quickly locate the faulty PV module based on the physical layout to rectify the fault. If a PV module without an optimizer is faulty, you need to check the PV

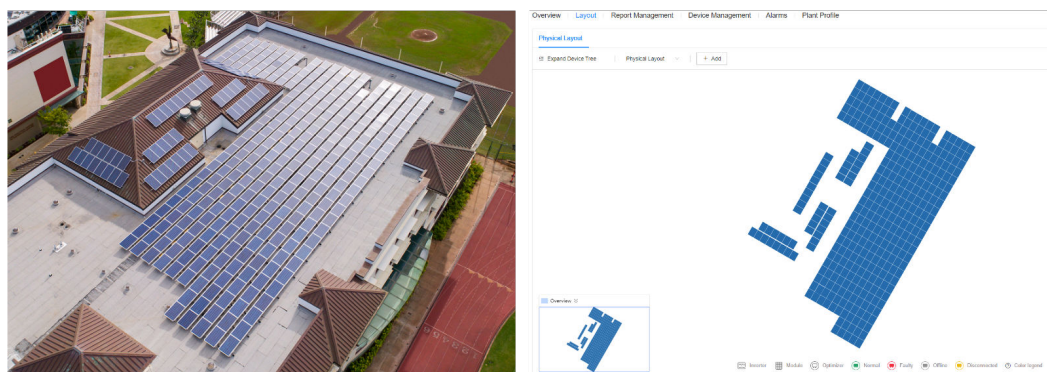
modules one by one to locate the faulty one, which is time-consuming and inefficient.

For details about the physical location layout of the optimizers, see [FusionSolar Physical Layout User Guide](#).

**Figure 7-6** Viewing a physical layout on the FusionSolar app



**Figure 7-7** Viewing a physical layout on the FusionSolar SmartPVMS



### 7.3.3 AFCI

#### Function

If PV modules or cables are not properly connected or damaged, electric arcs may occur, which may cause fire. Huawei SUN2000s provide unique arc detection in compliance with UL 1699B-2018 to ensure the safety of users' lives and property.

This function is enabled by default. The SUN2000 automatically detects arc faults. To disable this function, log in to the FusionSolar App, enter the **Device Commissioning** screen, choose **Settings > Feature parameters**, and disable **AFCI**.

#### NOTE

The AFCI function works only with Huawei optimizers or ordinary PV modules, but does not support third-party optimizers or intelligent PV modules.

## Clearing Alarms

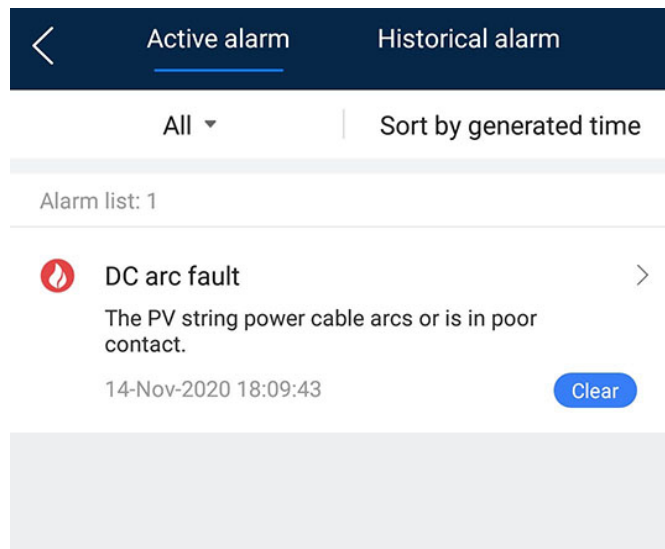
The AFCI function involves the **DC arc fault** alarm.

The SUN2000 has the AFCI alarm automatic clearance mechanism. If an alarm is triggered for less than five times within 24 hours, the SUN2000 automatically clears the alarm. If the alarm is triggered for five times or more within 24 hours, the SUN2000 locks for protection. You need to manually clear the alarm on the SUN2000 so that it can work properly.

You can manually clear the alarm as follows:

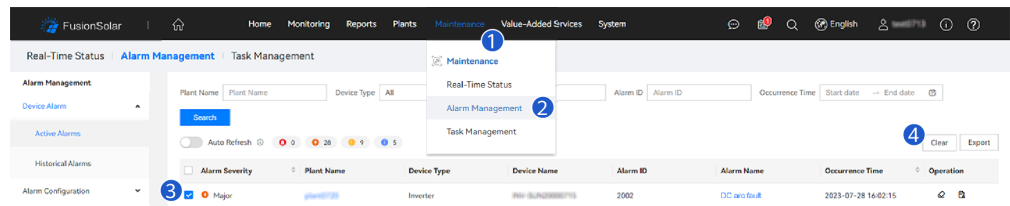
- **Method 1:** FusionSolar App  
Log in to the FusionSolar App and choose **Me > Device commissioning**. On the **Device commissioning** screen, connect and log in to the SUN2000 that generates the AFCI alarm, tap **Alarm management**, and tap **Clear** on the right of the **DC arc fault** alarm to clear the alarm.

**Figure 7-8** Alarm management



- **Method 2:** FusionSolar Smart PV Management System  
Log in to the FusionSolar Smart PV Management System using a non-owner account, choose **Maintenance > Alarm Management**, select the **DC arc fault** alarm, and click **Clear** to clear the alarm.

**Figure 7-9** Clearing alarms



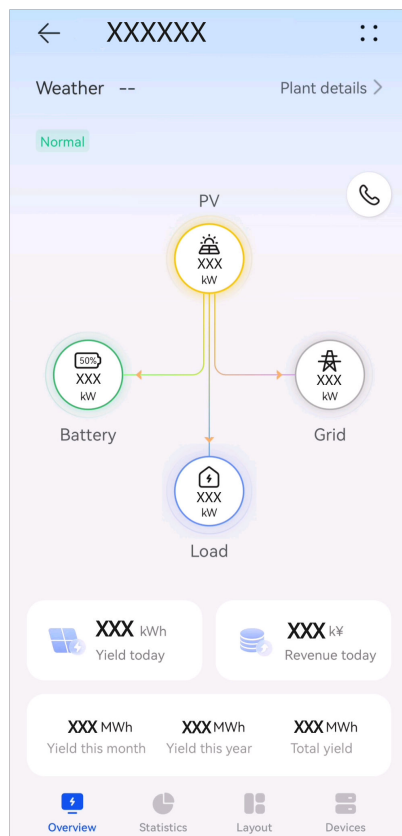
Switch to the owner account with PV plant management rights. On the home page, click the PV plant name to go to the PV plant page, and click **OK** as prompted to clear the alarm.

## 7.4 Viewing the Plant Creation Status

The FusionSolar app provides an overview of plants. You can view the plant running status, energy yield and consumption, revenue, and energy flow diagram in real time.

Log in to the app, tap **Home**, and tap **Plants**. This screen displays the real-time running status and basic information of all plants managed by the user by default.

**Figure 7-10** Viewing the plant creation status





## 7.5 SmartLogger Networking Scenario

See the [PV Plants Connecting to Huawei Hosting Cloud Quick Guide \(Inverters + SmartLogger3000 + RS485 Networking\)](#). You can scan the QR code to obtain it.

Figure 7-11 SmartLogger3000



# 8 System Maintenance

## DANGER

- Wear personal protective equipment and use dedicated insulated tools to avoid electric shocks or short circuits.

## WARNING

- Before performing maintenance, power off the equipment, follow the instructions on the delayed discharge label, and wait for a period of time as specified to ensure that the equipment is not energized.

## 8.1 Routine Maintenance

To ensure that the inverter can operate properly for a long term, you are advised to perform routine maintenance on it as described in this section.

## CAUTION

Power off the system before cleaning the system, connecting cables, and checking grounding reliability.

**Table 8-1** Maintenance checklist

Check Item	Check Method	Maintenance Interval
System cleanliness	Check periodically whether the heat sinks are blocked or dirty.	Once every 6 to 12 months

Check Item	Check Method	Maintenance Interval
Cleanness of air intake and exhaust vents	Check periodically whether there is dust or foreign objects at the air intake and exhaust vents.	Power off the inverter and remove dust and foreign objects. If necessary, remove the baffle plates from the air intake and exhaust vents for cleaning. Once every 6 to 12 months (or once every 3 to 6 months based on the actual dust conditions in the environment)
Fan	Check whether the fan generates abnormal noise during operation.	Remove foreign objects from the fan. If the abnormal noise persists, replace the fan. For details, see <a href="#">8.5 Replacing a Fan</a> . Once every 6 to 12 months
System running status	<ul style="list-style-type: none"> <li>• Check whether the inverter is damaged or deformed.</li> <li>• Check whether the inverter generates abnormal sound during operation.</li> <li>• Check whether all inverter parameters are correctly set during operation.</li> </ul>	Once every 6 months
Electrical connection	<ul style="list-style-type: none"> <li>• Check whether cables are disconnected or loose.</li> <li>• Check whether cables are damaged, especially whether the cable sheath that contacts a metal surface is damaged.</li> </ul>	6 months after the first commissioning and once every 6 to 12 months after that
Grounding reliability	Check whether the PE cable is securely connected.	6 months after the first commissioning and once every 6 to 12 months after that
Sealing	Check whether all terminals and ports are properly sealed.	Once a year

## 8.2 System Power-Off

### Precautions

---

 **WARNING**

- After the system is powered off, the inverter is still energized and hot, which may cause electric shocks or burns. Therefore, wait for 5 minutes after power-off and then put on insulated gloves to operate the inverter.
  - Power off the system before maintaining optimizers and PV strings. Otherwise, electric shocks may occur when the PV strings are energized.
- 

### Procedure

- Step 1** Send a shutdown command on the app.
- Step 2** Turn off the AC switch between the inverter and the power grid.
- Step 3** Set the **DC SWITCH** to **OFF**.
- Step 4** (Optional) Install the locking screw for the **DC SWITCH**.
- Step 5** Turn off the DC switch between the inverter and PV strings.
- Step 6** (Optional) Turn off the battery switch between the inverter and the battery.
- End

## 8.3 Troubleshooting

 **NOTE**

Contact your dealer if all failure analysis procedures listed above are completed and the fault still exists.

Alarm severities are defined as follows:

- Major: The inverter is faulty. As a result, the output power decreases or the grid-tied power generation is stopped.
- Minor: Some components are faulty without affecting the grid-tied power generation.
- Warning: The inverter works properly. The output power decreases or some authorization functions fail due to external factors.

**Table 8-2** Common alarms and troubleshooting measures

Alarm ID	Alarm Name	Alarm Severity	Possible Causes	Troubleshooting
2001	High string input voltage	Major	<p>The PV array is not properly configured. Excessive PV modules are connected in series to the PV string, and therefore the PV string open-circuit voltage exceeds the maximum inverter operating voltage.</p> <ul style="list-style-type: none"> <li>• Cause ID 1: PV strings 1 and 2</li> <li>• Cause ID 2: PV strings 3 and 4</li> </ul>	Reduce the number of PV modules connected in series to the PV string until the PV string open-circuit voltage is less than or equal to the maximum inverter operating voltage. After the PV string configuration is corrected, the alarm disappears.
2003	DC arc fault	Major	<p>The PV string power cables arc or are in poor contact.</p> <p>Cause ID 1-4: PV strings 1-4</p>	Check whether the PV string cables arc or are in poor contact.
2011	String reverse connection	Major	<p>The PV string polarity is reversed.</p> <p>Cause ID 1-4: PV strings 1-4</p>	Check whether the PV string is reversely connected to the inverter. If yes, wait until the solar irradiance declines at night and the PV string current drops to below 0.5 A. Then, turn off the DC switch and correct the PV string connection.

Alarm ID	Alarm Name	Alarm Severity	Possible Causes	Troubleshooting
2012	String current backfeed	Warning	The number of PV modules connected in series to the PV string is insufficient. As a result, the terminal voltage is lower than that of other strings. Cause ID 1-4: PV strings 1-4	<ol style="list-style-type: none"> <li>1. Check whether the number of PV modules connected in series to the PV string is less than that of other PV strings. If yes, wait until the PV string current drops below 0.5 A, turn off all DC switches, and adjust the number of PV modules in the PV string.</li> <li>2. Check whether the open-circuit voltage of the PV string is abnormal.</li> <li>3. Check whether the PV string is shaded.</li> </ol>
2021	AFCI self-check failure	Major	Cause ID = 1 The AFCI self-check fails.	Turn off the AC output switch and DC input switch, and then turn them on after 5 minutes. If the alarm persists, contact Huawei technical support.
2031	Phase wire short-circuited to PE	Major	Cause ID = 1 The impedance of the output phase wire to PE is low or the output phase wire is short-circuited to PE.	Check the impedance of the output phase wire to PE, locate the position with low impedance, and rectify the fault.
2032	Grid loss	Major	Cause ID = 1 <ul style="list-style-type: none"> <li>• Power grid outage occurs.</li> <li>• The AC circuit is disconnected or the AC switch is off.</li> </ul>	<ol style="list-style-type: none"> <li>1. The alarm is cleared automatically after the power grid recovers.</li> <li>2. Check whether the AC circuit is disconnected or the AC switch is off.</li> </ol>

Alarm ID	Alarm Name	Alarm Severity	Possible Causes	Troubleshooting
2033	Grid undervoltage	Major	<p>Cause ID = 1</p> <p>The power grid voltage is below the lower threshold or the low-voltage duration has lasted for more than the value specified by LVRT.</p>	<ol style="list-style-type: none"> <li>1. If the alarm occurs occasionally, the power grid may be abnormal temporarily. The inverter automatically recovers after detecting that the power grid becomes normal.</li> <li>2. If the alarm persists, check whether the power grid voltage is within the acceptable range. If not, contact the local power operator. If yes, modify the grid undervoltage protection threshold through the app, SmartLogger, or NMS with the consent of the local power operator.</li> <li>3. If the alarm persists for a long time, check the AC circuit breaker and AC output power cable.</li> </ol>
2034	Grid overvoltage	Major	<p>Cause ID = 1</p> <p>The power grid voltage exceeds the upper threshold or the high voltage duration has lasted for more than the value specified by HVRT.</p>	<ol style="list-style-type: none"> <li>1. If the alarm occurs occasionally, the power grid may be abnormal temporarily. The inverter automatically recovers after detecting that the power grid becomes normal.</li> <li>2. If the alarm persists, check whether the power grid frequency is within the acceptable range. If not, contact the local power operator. If yes, modify the grid overfrequency protection threshold through the app, SmartLogger, or NMS with the consent of the local power operator.</li> <li>3. Check whether the peak voltage of the power grid is too high. If the alarm persists and lasts for a long time, contact the local power operator.</li> </ol>

Alarm ID	Alarm Name	Alarm Severity	Possible Causes	Troubleshooting
2035	Grid volt. Imbalance	Major	Cause ID = 1 The difference between power grid phase voltages exceeds the upper threshold.	<ol style="list-style-type: none"> <li>1. If the alarm occurs occasionally, the power grid may be abnormal temporarily. The inverter automatically recovers after detecting that the power grid becomes normal.</li> <li>2. If the alarm persists, check whether the power grid voltage is within the acceptable range. If not, contact the local power operator.</li> <li>3. If the alarm lasts for a long time, check the AC output power cable connection.</li> <li>4. If the AC output power cable is correctly connected, yet the alarm persists and affects the energy yield of the PV plant, contact the local power operator.</li> </ol>
2036	Grid overfrequency	Major	Cause ID = 1 Power grid exception: The actual power grid frequency is higher than the requirements for the local power grid code.	<ol style="list-style-type: none"> <li>1. If the alarm occurs occasionally, the power grid may be abnormal temporarily. The inverter automatically recovers after detecting that the power grid becomes normal.</li> <li>2. If the alarm persists, check whether the power grid frequency is within the acceptable range. If not, contact the local power operator. If yes, modify the grid overfrequency protection threshold through the app, SmartLogger, or NMS with the consent of the local power operator.</li> </ol>



Alarm ID	Alarm Name	Alarm Severity	Possible Causes	Troubleshooting
2037	Grid underfrequency	Major	Cause ID = 1 Power grid exception: The actual power grid frequency is lower than the requirements for the local power grid code.	<ol style="list-style-type: none"> <li>1. If the alarm occurs occasionally, the power grid may be abnormal temporarily. The inverter automatically recovers after detecting that the power grid becomes normal.</li> <li>2. If the alarm persists, check whether the power grid frequency is within the acceptable range. If not, contact the local power operator. If yes, modify the grid underfrequency protection threshold through the app, SmartLogger, or NMS with the consent of the local power operator.</li> </ol>
2038	Unstable grid frequency	Major	Cause ID = 1 Power grid exception: The actual change rate of the power grid frequency does not meet the requirements for the local power grid code.	<ol style="list-style-type: none"> <li>1. If the alarm occurs occasionally, the power grid may be abnormal temporarily. The inverter automatically recovers after detecting that the power grid becomes normal.</li> <li>2. If the alarm persists, check whether the power grid frequency is within the acceptable range. If not, contact the local power operator.</li> </ol>
2039	AC Overcurrent	Major	Cause ID = 1 The power grid voltage drops dramatically or the power grid is short-circuited. As a result, the inverter transient output current exceeds the upper threshold, and protection is triggered.	<ol style="list-style-type: none"> <li>1. The inverter monitors its external operating conditions in real time and automatically recovers after the fault is rectified.</li> <li>2. If the alarm persists and affects the energy yield of the PV plant, check whether the output is short-circuited. If the fault cannot be rectified, contact your dealer or Huawei technical support.</li> </ol>

Alarm ID	Alarm Name	Alarm Severity	Possible Causes	Troubleshooting
2040	Output DC component overhigh	Major	Cause ID = 1 The DC component of the inverter output current exceeds the upper threshold.	<ol style="list-style-type: none"> <li>1. The inverter monitors its external operating conditions in real time and automatically recovers after the fault is rectified.</li> <li>2. If the alarm persists and affects the energy yield of the PV plant, contact your dealer or Huawei technical support.</li> </ol>
2051	Abnormal residual current	Major	Cause ID = 1 The insulation impedance of the input side to PE decreases when the inverter is operating.	<ol style="list-style-type: none"> <li>1. If the alarm occurs accidentally, the external power cable may be abnormal temporarily. The inverter automatically recovers after the fault is rectified.</li> <li>2. If the alarm persists or lasts a long time, check whether the impedance between the PV string and ground is too low.</li> </ol>
2061	Abnormal grounding	Major	Cause ID = 1 <ul style="list-style-type: none"> <li>• The neutral wire or PE cable of the inverter is not connected.</li> <li>• The output mode set for the inverter is inconsistent with the cable connection mode.</li> </ul>	Power off the inverter (turn off the AC output switch and DC input switch, and wait for a period of time. For details about the wait time, see the description on the device safety warning label), and then perform the following operations: <ol style="list-style-type: none"> <li>1. Check whether the PE cable for the inverter is connected properly.</li> <li>2. If the inverter is connected to a TN power grid, check whether the neutral wire is properly connected and whether the voltage of the neutral wire to ground is normal.</li> <li>3. After the inverter is powered on, check whether the output mode set for the inverter is consistent with the output cable connection mode.</li> </ol>

Alarm ID	Alarm Name	Alarm Severity	Possible Causes	Troubleshooting
2062	Low insulation resistance	Major	Cause ID = 1 <ul style="list-style-type: none"> <li>The PV array is short-circuited with PE.</li> <li>The PV string has been in a moist environment for a long time and the circuit is not well insulated to ground.</li> </ul>	<ol style="list-style-type: none"> <li>Check the impedance between the PV string and the PE cable. If a short circuit occurs, rectify the fault.</li> <li>Check whether the PE cable of the inverter is correctly connected.</li> <li>If you have confirmed that the impedance is lower than the specified protection threshold in a cloudy or rainy environment, log in to the app, SmartLogger, or NMS and set <b>Insulation resistance protection threshold</b>.</li> </ol>
2063	Cabinet overtemperature	Minor	Cause ID = 1 <ul style="list-style-type: none"> <li>The inverter is installed in a place with poor ventilation.</li> <li>The ambient temperature exceeds the upper threshold.</li> <li>The inverter is not operating properly.</li> </ul>	<ol style="list-style-type: none"> <li>Check the ventilation and ambient temperature at the inverter installation position.</li> <li>If the ventilation is poor or the ambient temperature exceeds the upper threshold, improve the ventilation and heat dissipation.</li> <li>If both the ventilation and ambient temperature meet requirements yet the alarm persists, contact your dealer or Huawei technical support.</li> </ol>
2064	Device fault	Major	Cause ID = 1-5, 7-12  An unrecoverable fault occurs on a circuit inside the inverter.	Turn off the AC output switch and DC input switch, and then turn them on after 5 minutes. If the alarm persists, contact your dealer or Huawei technical support.  <b>NOTICE</b> Cause ID = 1: Perform the preceding operations when the PV string current is less than 1 A.

Alarm ID	Alarm Name	Alarm Severity	Possible Causes	Troubleshooting
2065	Upgrade failed or version mismatch	Minor	Cause ID = 1-4, 7 The upgrade is not completed normally.	<ol style="list-style-type: none"> <li>1. Perform an upgrade again.</li> <li>2. If the upgrade fails several times, contact your dealer or Huawei technical support.</li> </ol>
61440	Faulty monitoring unit	Minor	Cause ID = 1 <ul style="list-style-type: none"> <li>• The flash memory is insufficient.</li> <li>• The flash memory has bad sectors.</li> </ul>	Turn off the AC output switch and DC input switch, and then turn them on after 5 minutes. If the alarm persists, replace the monitoring board or contact your dealer or Huawei technical support.
2067	Faulty power collector	Major	Cause ID = 1 The power meter is disconnected.	<ol style="list-style-type: none"> <li>1. Check whether the configured power meter model is the same as the actual model.</li> <li>2. Check whether the communications parameters of the power meter are the same as the RS485 configurations of the inverter.</li> <li>3. Check whether the power meter is powered on and whether the RS485 communications cable is connected.</li> </ol>

Alarm ID	Alarm Name	Alarm Severity	Possible Causes	Troubleshooting
2080	Abnormal PV module configuration	Major	<ul style="list-style-type: none"> <li>● Cause ID = 2 The PV string power or the number of optimizers connected in series in a PV string exceeds the upper threshold.</li> <li>● Cause ID = 3 The number of optimizers connected in series in a PV string is less than the lower threshold, the PV string output is reversely connected, or the output of some optimizers in the PV string is reversely connected.</li> <li>● Cause ID = 6 Under the same MPPT, the number of optimizers connected in series in PV strings connected in parallel is different, or the output of some optimizers in</li> </ul>	<p>Check whether the total number of PV modules, number of PV modules in a PV string, and number of PV strings meet requirements and whether the PV module output is reversely connected.</p> <ul style="list-style-type: none"> <li>● Cause ID 2: Check whether the PV string power or the number of PV strings connected in series exceeds the upper threshold.</li> <li>● Cause ID 3:               <ol style="list-style-type: none"> <li>1. Check whether the number of optimizers connected in series in the PV string is below the lower threshold.</li> <li>2. Check whether the PV string output is reversely connected.</li> <li>3. Check whether the PV string output is disconnected.</li> <li>4. Check whether the optimizer output extension cable is correct (positive connector at one end and negative connector at the other).</li> </ol> </li> <li>● Cause ID 6:               <ol style="list-style-type: none"> <li>1. Check whether the number of optimizers connected in series in the PV strings connected in parallel under the same MPPT is the same.</li> <li>2. Check whether the optimizer output extension cable is correct (positive connector at one end and negative connector at the other).</li> </ol> </li> <li>● Cause ID 7: When the sunlight is normal, perform the optimizer search function again.</li> </ul>

Alarm ID	Alarm Name	Alarm Severity	Possible Causes	Troubleshooting
			<p>PV strings is reversely connected.</p> <ul style="list-style-type: none"> <li>● Cause ID = 7 The optimizer installation position is changed, or PV strings are combined or exchanged.</li> <li>● Cause ID = 8 The sunlight is weak or changes abnormally.</li> <li>● Cause ID = 9 In partial configuration scenarios, the PV string voltage exceeds the inverter input voltage specifications.</li> </ul>	<ul style="list-style-type: none"> <li>● Cause ID 8: When the sunlight is normal, perform the optimizer search function again.</li> <li>● Cause ID 9: Calculate the PV string voltage based on the number of PV modules in the string and check whether the string voltage exceeds the upper threshold of the inverter input voltage.</li> </ul>
2081	Optimizer fault	Warning	<p>Cause ID = 1 The optimizer is offline or faulty.</p>	<p>Go to the optimizer information screen to view the fault details.</p>

Alarm ID	Alarm Name	Alarm Severity	Possible Causes	Troubleshooting
2085	Built-in PID operation abnormal	Minor	Cause ID = 1, 2 <ul style="list-style-type: none"> <li>• The output resistance of PV arrays to ground is low.</li> <li>• The system insulation resistance is low.</li> </ul>	<ul style="list-style-type: none"> <li>• Cause ID = 1                             <ol style="list-style-type: none"> <li>1. Turn off the AC output switch and DC input switch, wait for a period of time (for details about the wait time, see the description on the device safety warning label), and then turn on the DC input switch and AC output switch.</li> <li>2. If the alarm persists, contact your dealer or Huawei technical support.</li> </ol> </li> <li>• Cause ID = 2                             <ol style="list-style-type: none"> <li>1. Check the impedance between the PV array output and the ground. If a short circuit occurs or the insulation is insufficient, rectify the fault.</li> <li>2. If the alarm persists, contact your dealer or Huawei technical support.</li> </ol> </li> </ul>
2086	External fan abnormal	Major	Cause ID = 1 The external fan is short-circuited, the power supply is insufficient, or the air channel is blocked.	<ol style="list-style-type: none"> <li>1. Shut down the fan, turn off the DC switch, check whether the fan blades are damaged, and clear the foreign matter around the fan.</li> <li>2. Reinstall the fan, turn on the DC switch, and wait for the inverter to start. If the alarm persists after 15 minutes, replace the external fan.</li> </ol>

Alarm ID	Alarm Name	Alarm Severity	Possible Causes	Troubleshooting
2090	Abnormal active power scheduling instruction	Major	Cause ID = 1 <ul style="list-style-type: none"> <li>The DI input is abnormal.</li> <li>The DI input is inconsistent with the configuration.</li> </ul>	<ol style="list-style-type: none"> <li>Check whether the cables are connected correctly to the DI ports.</li> <li>On the <b>DI active scheduling</b> screen under the dry contact scheduling settings, view the DI signal configuration mapping table. Contact the power grid company to check whether the configurations in the mapping table are complete and meet the requirements.</li> </ol>
2091	Abnormal reactive power scheduling instruction	Major	Cause ID = 1 <ul style="list-style-type: none"> <li>The DI input is abnormal.</li> <li>The DI input is inconsistent with the configuration.</li> </ul>	<ol style="list-style-type: none"> <li>Check whether the cables are connected correctly to the DI ports.</li> <li>On the <b>DI reactive power scheduling</b> screen under the dry contact scheduling settings, view the DI signal configuration mapping table. Contact the power grid company to check whether the configurations in the mapping table are complete and meet the requirements.</li> </ol>
2102	Protection upon Communication Failure	Warning	Cause ID = 1 When the disconnection of communication exceeds the specified time threshold, the device starts the protection function.	<ol style="list-style-type: none"> <li>Check whether the communications cable is connected properly.</li> <li>After communication is restored, the device will recover upon receiving a scheduling command.</li> <li>If the <b>Protection upon Communication Failure</b> function is not required, disable it.</li> </ol>

## 8.4 Replacing an Inverter

### Step 1 Remove the inverter.

- Power off the system. For details, see [8.2 System Power-Off](#).
- Disconnect all cables from the inverter, including signal cables, DC input power cables, battery cables, AC output power cables, and PE cables.



3. Remove the inverter from the mounting bracket.
4. Remove the mounting bracket.

**Step 2** Pack the inverter.

- If the original packaging is available, put the inverter inside it and then seal it using adhesive tape.
- If the original packaging is unavailable, put the inverter inside a suitable hard cardboard box and seal it properly.

**Step 3** Dispose of the inverter.

If the inverter reaches the end of its service life, dispose of it according to local regulations for the disposal of electrical equipment.

**Step 4** Install a new inverter.

----End

## 8.5 Replacing a Fan

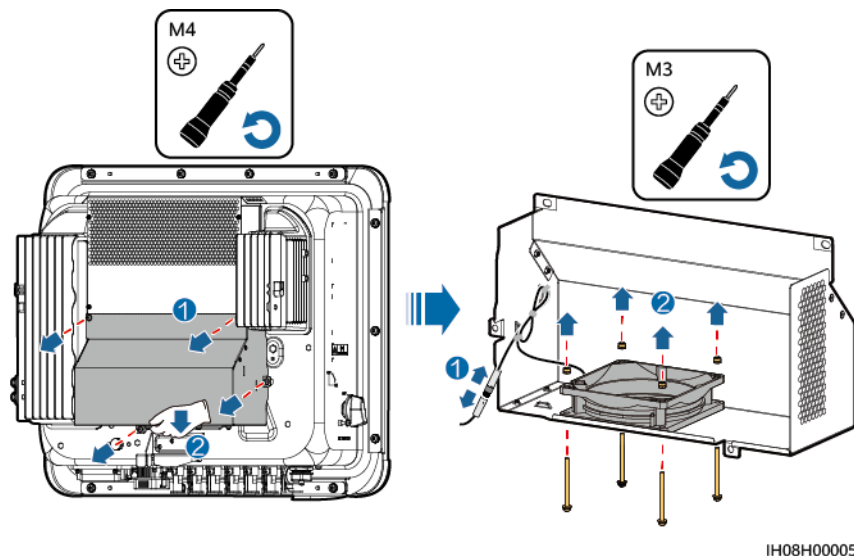
**CAUTION**

- Before replacing a fan, power off the inverter.
- When replacing a fan, use insulated tools and wear PPE.

### Procedure

- Step 1** Remove the fan cover, disconnect fan cables, and remove the faulty fan.

**Figure 8-1** Removing the faulty fan



- Step 2** Install a new fan, connect and bind the cables, and install the fan cover.

----End

## 8.6 Locating Insulation Resistance Faults

If the ground resistance of a PV string connected to the inverter is too low, the inverter generates a **Low insulation resistance** alarm. The alarm ID is 2062.

The possible causes are as follows:

- A short circuit has occurred between the PV array and the ground.
- The ambient air of the PV array is damp and the insulation between the PV array and the ground is poor.

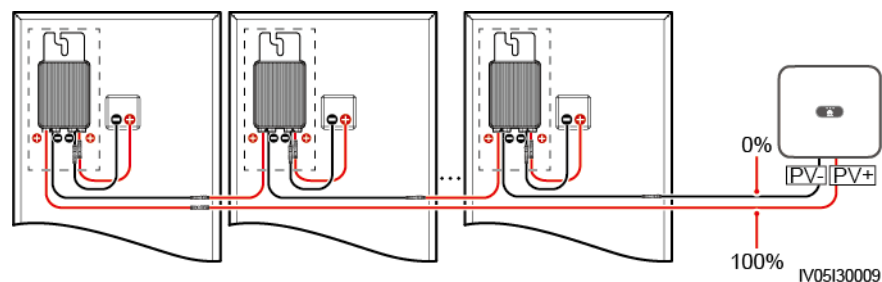
After the **Low insulation resistance** alarm is reported by the inverter, insulation resistance fault location is automatically triggered. If the fault location is successful, the location information is displayed on the **Alarm details** screen of the **Low insulation resistance** alarm on the FusionSolar app.

Log in to the FusionSolar app, choose **Alarm > Active alarm**, select **Low insulation resistance** to enter the **Alarm details** screen.

### NOTE

- The positive and negative terminals of a PV string are respectively connected to the PV+ and PV- terminals of the inverter. The PV- terminal represents a possibility of 0% for the short-circuit position and the PV+ terminal represents a possibility of 100% for the short-circuit position. Other percentages indicate that the fault occurs on a PV module or cable in the PV string.
- Possible fault position = Total number of PV modules in a PV string x Percentage of possible short-circuit positions. For example, if a PV string consists of 14 PV modules and the percentage of the possible short-circuit position is 34%, the possible fault position is 4.76 (14 x 34%), indicating that the fault is located near PV module 4, including the previous and the next PV modules and the cables. The inverter has a detection precision of  $\pm 1$  PV module.
- The possible faulty PV string MPPT1 corresponds to PV1 and PV2, and the possible faulty PV string MPPT2 corresponds to PV3 and PV4. The fault can be located only to the MPPT level. Perform the following steps to connect the PV strings corresponding to the faulty MPPT to the inverter one by one to further locate and rectify the fault.
- When a non-short-circuit fault occurs, the possible short-circuit percentage is not displayed. If the insulation resistance is greater than  $0.001 \text{ M}\Omega$ , the fault is not related to short circuit. Check all PV modules in the faulty PV string one by one to locate and rectify the fault.

**Figure 8-2** Percentage of short-circuit positions



## Procedure

### NOTICE

If the irradiance or the PV string voltage is too high, the insulation resistance fault location may fail. In this case, the fault location status on the **Alarm details** screen is **Conditions not met**. Perform the following steps to connect PV strings to the inverter one by one to locate the fault. If the system is not configured with any optimizer, skip the corresponding optimizer operations.

- Step 1** Ensure that the AC connections are normal. Log in to the FusionSolar app, choose **Maintenance > Inverter ON/OFF** on the home screen, and send a shutdown command. Set **DC SWITCH** to **OFF**.
- Step 2** Connect one PV string to the inverter, and set **DC SWITCH** to **ON**. If the inverter status is **Shutdown: Command**, log in to the app, choose **Maintenance > Inverter ON/OFF** on the home screen, and send a startup command.
- Step 3** Choose **Alarm** on the home screen, enter the **Active alarm** screen, and check whether a **Low insulation resistance** alarm is reported.
  - If no **Low insulation resistance** alarm is reported 1 minute after the DC side is powered on, choose **Maintenance > Inverter ON/OFF** on the home screen, and send a shutdown command. Set **DC SWITCH** to **OFF**. Go to **Step 2** and check rest of the PV strings one by one.
  - If a **Low insulation resistance** alarm is reported 1 minute after the DC side is powered on, check the percentage of possible short-circuit positions on the **Alarm details** screen and calculate the location of the possible faulty PV module based on the percentage. Then go to **Step 4**.
- Step 4** Log in to the app, choose **Maintenance > Inverter ON/OFF** on the home screen, and send a shutdown command. Set **DC SWITCH** to **OFF**. Check whether the connectors or DC power cables between the optimizer and PV module, between adjacent PV modules, or between adjacent optimizers on the possible fault position are damaged.
  - If yes, replace the damaged connectors or DC power cables, and then set **DC SWITCH** to **ON**. If the inverter status is **Shutdown: Command**, choose **Maintenance > Inverter ON/OFF**, and send a startup command. View alarm information.
    - If no **Low insulation resistance** alarm is reported 1 minute after the DC side is powered on, troubleshoot the insulation resistance fault of the PV string. Log in to the app, choose **Maintenance > Inverter ON/OFF** on the home screen, and send a shutdown command. Set **DC SWITCH** to **OFF**. Go to **Step 2** and check rest of the PV strings one by one. Then, go to **Step 8**.
    - If the DC side is powered on 1 minute later, the **Low insulation resistance** alarm is still reported. Log in to the app, choose **Maintenance > Inverter ON/OFF** on the home screen, and send a shutdown command. Set **DC SWITCH** to **OFF** and go to **Step 5**.
  - If no, go to **Step 5**.
- Step 5** Disconnect the possible faulty PV module and the paired optimizer from the PV string, and use a DC extension cable with an MC4 connector to connect the PV

module or optimizer adjacent to the possible faulty PV module. Set **DC SWITCH** to **ON**. If the inverter status is **Shutdown: Command**, choose **Maintenance > Inverter ON/OFF** on the home screen, and send a startup command. View alarm information.

- If no **Low insulation resistance** alarm is reported 1 minute after the DC side is powered on, the fault occurred on the disconnected PV module and optimizer. Choose **Maintenance > Inverter ON/OFF**, send a shutdown command, and set **DC SWITCH** to **OFF**. Go to [Step 7](#).
- If the **Low insulation resistance** alarm is reported 1 minute after the DC side is powered on, the fault did not occur on the disconnected PV module and optimizer. Go to [Step 6](#).

**Step 6** Log in to the app, choose **Maintenance > Inverter ON/OFF** on the home screen, and send a shutdown command. Set **DC SWITCH** to **OFF**, reconnect the disconnected PV module and optimizer, and repeat [Step 5](#) to check the PV modules and optimizers adjacent to the possible fault location.

**Step 7** Determine the position of the ground insulation fault:

- Disconnect the possible faulty PV module from the optimizer.
- Connect the possible faulty optimizer to the PV string.
- Set **DC SWITCH** to **ON**. If the inverter status is **Shutdown: Command**, choose **Maintenance > Inverter ON/OFF**, and send a startup command. View alarm information.
  - If no **Low insulation resistance** alarm is reported 1 minute after the DC side is powered on, the fault is on the possible faulty PV module.
  - If the **Low insulation resistance** alarm is reported 1 minute after the DC side is powered on, the fault is on the possible faulty optimizer.
- Log in to the app, choose **Maintenance > Inverter ON/OFF** on the home screen, and send a shutdown command. Set **DC SWITCH** to **OFF**, replace the faulty component, and complete troubleshooting the insulation resistance fault. Go to [Step 2](#) and check rest of the PV strings one by one. Then, go to [Step 8](#).

**Step 8** Set **DC SWITCH** to **ON**. If the inverter status is **Shutdown: Command**, choose **Maintenance > Inverter ON/OFF**, and send a startup command.

----End

# 9 Technical Specifications

## 9.1 SUN2000-(15K-25K)-MB0-ZH Technical Specifications

### Efficiency

Technical Specifications	SUN2000-15 K-MB0-ZH	SUN2000-17 K-MB0-ZH	SUN2000-20 K-MB0-ZH	SUN2000-25 K-MB0-ZH
Maximum efficiency	98.5%	98.5%	98.5%	98.5%
Chinese efficiency	97.4%	97.5%	97.6%	98.0%

### Input

Technical Specifications	SUN2000-15 K-MB0-ZH	SUN2000-17 K-MB0-ZH	SUN2000-20 K-MB0-ZH	SUN2000-25 K-MB0-ZH
Recommended maximum input DC power	22500 W	25500 W	30000 W	37500 W
Maximum input voltage <sup>a</sup>	1100 V			
Maximum input current per MPPT	20 A (one PV string)/30 A (one MPPT)			

Technical Specifications	SUN2000-15 K-MB0-ZH	SUN2000-17 K-MB0-ZH	SUN2000-20 K-MB0-ZH	SUN2000-25 K-MB0-ZH
Maximum short-circuit current per MPPT	40 A			
Minimum startup voltage	200 V			
MPPT voltage range	200–1000 V			
Full-load MPPT voltage range	410–800 V	440–800 V	480–800 V	530–800 V
Rated input voltage	600 V			
Maximum number of inputs	4			
Number of MPPTs	2			
Rated battery voltage	600 V DC			
Battery voltage range	600–980 V DC			
Maximum battery current	26.25 A			
Battery type	Li-ion			
Note a: The maximum input voltage is the maximum DC input voltage that the inverter can withstand. If the input voltage exceeds this value, the inverter may be damaged.				

## Output

Technical Specifications	SUN2000-15 K-MB0-ZH	SUN2000-17 K-MB0-ZH	SUN2000-20K -MB0-ZH	SUN2000-25 K-MB0-ZH
Rated output power	15000 W	17000 W	20000 W	25000 W

Technical Specifications	SUN2000-15 K-MB0-ZH	SUN2000-17 K-MB0-ZH	SUN2000-20K -MB0-ZH	SUN2000-25 K-MB0-ZH
Maximum apparent power	16500 VA	18700 VA	22000 VA	27500 VA
Maximum active power (cosφ = 1)	16500 W	18700 W	22000 W	27500 W
Rated output voltage	220 V/380 V, 3W/N+PE 230 V/400 V, 3W/N+PE			
Maximum output voltage at long-term operation	Refer to the local power grid standards.			
Rated output current	22.8 A/380 V 21.7 A/400 V	25.8 A/380 V 24.5 A/400 V	30.4 A/380 V 28.9 A/400 V	38.0 A/380 V 36.1 A/400 V
Maximum output current	25.2 A/380 V 23.9 A/400 V	28.6 A/380 V 27.1 A/400 V	33.6 A/380 V 31.9 A/400 V	42.0 A/380 V 39.9 A/400 V
Output voltage frequency	50 Hz/60 Hz			
Power factor	0.8 leading ... 0.8 lagging			
Output DC component (DCI)	< 0.5% of the rated output			
Maximum total harmonic distortion (AC THDi)	< 3% under rated conditions. Single harmonic meets the VDE 4105 requirements.			

## Protection

Technical Specifications	SUN2000-15 K-MB0-ZH	SUN2000-17 K-MB0-ZH	SUN2000-20 K-MB0-ZH	SUN2000-25 K-MB0-ZH
Overvoltage category	PV II/AC III			

Technical Specifications	SUN2000-15 K-MB0-ZH	SUN2000-17 K-MB0-ZH	SUN2000-20 K-MB0-ZH	SUN2000-25 K-MB0-ZH
Input DC switch	Supported			
Anti-islanding protection	Supported			
Output overcurrent protection	Supported			
Input reverse connection protection	Supported			
DC surge protection	TYPE II			
AC surge protection	Yes, compatible with TYPE II protection class according to EN/IEC 61643-11			
Insulation resistance detection	Supported			
Residual current monitoring unit (RCMU)	Supported			

## Display and Communication

Technical Specifications	SUN2000-15 K-MB0-ZH	SUN2000-17 K-MB0-ZH	SUN2000-20 K-MB0-ZH	SUN2000-25 K-MB0-ZH
Display	LED indicators; WLAN+app			
WLAN-FE Dongle	Supported			
4G Smart Dongle	Standard			
RS485 communication	Supported			
Built-in WLAN	Supported			
DC MBUS	Supported			



Technical Specifications	SUN2000-15 K-MB0-ZH	SUN2000-17 K-MB0-ZH	SUN2000-20 K-MB0-ZH	SUN2000-25 K-MB0-ZH
AFCI	Supported			
PID recovery	Supported			

## General Specifications

Technical Specifications	SUN2000-15 K-MB0-ZH	SUN2000-17 K-MB0-ZH	SUN2000-20 K-MB0-ZH	SUN2000-25 K-MB0-ZH
Dimensions (H x W x D)	460 mm x 546 mm x 228 mm			
Net weight	21 kg			
Noise	< 45 dB (typical working condition)	< 45 dB (typical working condition)	< 50 dB (typical working condition)	< 50 dB (typical working condition)
Operating temperature	-25°C to +60°C			
Relative humidity	0-100% RH			
Cooling mode	Smart air cooling			
Maximum operating altitude	4000 m (derated when the altitude is greater than 2000 m)			
Storage temperature	-40°C to +70°C			
IP rating	IP66			
Topology	Transformerless			

## Wireless Communication Parameters

Technical Specifications	Inverter Built-in WiFi	WLAN-FE Smart Dongle	4G Smart Dongle
Frequency	2400–2483.5 MHz	SDongleA-05: 2400–2483.5 MHz	SDongleB-03-CN: <ul style="list-style-type: none"> <li>● Supports LTE FDD: B1/B3/B5/B8.</li> <li>● Supports LTE TDD: B34/B38/B39/B40/B41.</li> <li>● Supports GSM/GPRS/EDGE: 900 MHz/1800 MHz.</li> </ul> SDongleB-06-CN (WiFi): 2400–2483.5 MHz SDongleB-06-CN (4G): <ul style="list-style-type: none"> <li>● Supports LTE FDD: B1/B3/B5/B8.</li> <li>● Supports LTE TDD: B34/B38/B39/B40/B41.</li> <li>● Supports GSM/GPRS/EDGE: 900 MHz/1800 MHz.</li> </ul>

Technical Specifications	Inverter Built-in WiFi	WLAN-FE Smart Dongle	4G Smart Dongle
Protocols and standards	WLAN 802.11b/g/n	SDongleA-05: WLAN 802.11b/g/n	SDongleB-03-CN: <ul style="list-style-type: none"> <li>● Supports LTE FDD (with receive diversity): B1/B3/B5/B8.</li> <li>● Supports LTE TDD (with receive diversity): B34/B38/B39/B40/B41.</li> <li>● Supports GSM: 900 MHz/1800 MHz.</li> <li>● Supports digital audio.</li> </ul> SDongleB-06-CN (WiFi): WLAN 802.11b/g/n SDongleB-06-CN (4G): <ul style="list-style-type: none"> <li>● Supports LTE FDD (with receive diversity): B1/B3/B5/B8.</li> <li>● Supports LTE TDD (with receive diversity): B34/B38/B39/B40/B41.</li> <li>● Supports GSM: 900 MHz/1800 MHz.</li> <li>● Supports digital audio.</li> </ul>

Technical Specifications	Inverter Built-in WiFi	WLAN-FE Smart Dongle	4G Smart Dongle
Bandwidth	20 MHz/40 MHz (optional)	20 MHz/40 MHz (optional)	<p>LTE features:</p> <ul style="list-style-type: none"> <li>● Supports a maximum of 3GPP R8 non-CA Cat 4 FDD and TDD.</li> <li>● Supports 1.4 MHz/3 MHz/5 MHz/10 MHz/15 MHz/20 MHz RF bandwidth.</li> <li>● Supports MIMO in the downlink.</li> <li>● LTE FDD: maximum downlink rate of 150 Mbit/s and maximum uplink rate of 50 Mbit/s</li> <li>● LTE TDD: maximum downlink rate of 130 Mbit/s and maximum uplink rate of 30 Mbit/s</li> </ul> <p>UMTS features:</p> <ul style="list-style-type: none"> <li>● Supports 3GPP R7 HSDPA+, HSDPA, HSUPA, and WCDMA.</li> <li>● Supports QPSK and 16QAM modulation.</li> <li>● HSDPA+: maximum downlink rate of 21 Mbit/s</li> <li>● HSUPA: maximum uplink rate of 5.76 Mbit/s</li> <li>● WCDMA: maximum downlink rate of 384 kbit/s and maximum uplink rate of 384 kbit/s</li> </ul> <p>GSM features:</p> <p>GPRS:</p> <ul style="list-style-type: none"> <li>● Supports GPRS multislots class 12.</li> <li>● Coding schemes: CS-1, CS-2, CS-3, and CS-4</li> <li>● Maximum downlink rate: 85.6 kbit/s; maximum uplink rate: 85.6 kbit/s</li> </ul> <p>EDGE:</p>

Technical Specifications	Inverter Built-in WiFi	WLAN-FE Smart Dongle	4G Smart Dongle
			<ul style="list-style-type: none"> <li>• Supports EDGE multislot class 12.</li> <li>• Supports GMSK and 8-PSK modulation and coding schemes.</li> <li>• Downlink coding format: MCS 1-9</li> <li>• Uplink coding format: MCS 1-9</li> <li>• Maximum downlink rate: 236.8 kbit/s; maximum uplink rate: 236.8 kbit/s</li> </ul> SDongleB-06-CN (WiFi): 20 MHz/40 MHz (optional)
Maximum transmit power	≤ 20 dBm EIRP	≤ 20 dBm EIRP	<ul style="list-style-type: none"> <li>• Class 4 (33 dBm±2 dB), EGSM900 frequency band</li> <li>• Class 1 (30 dBm±2 dB), DCS1800 frequency band</li> <li>• Class E2 (27 dBm±3 dB), EGSM900 8-PSK</li> <li>• Class E2 (26 dBm±3 dB), DCS1800 8-PSK</li> <li>• Class 3 (24 dBm+1/-3 dB), WCDMA frequency band</li> <li>• Class 3 (23 dBm±2 dB), LTE FDD frequency band</li> <li>• Class 3 (23 dBm±2 dB), LTE TDD frequency band</li> </ul> SDongleB-06-CN (WiFi): ≤ 20 dBm EIRP

## 9.2 SUN2000-(12K-25K)-MB0 Technical Specifications

### Efficiency

Technical Specifications	SUN2000-12K-MB0	SUN2000-15K-MB0	SUN2000-17K-MB0	SUN2000-20K-MB0	SUN2000-25K-MB0
Maximum efficiency	98.4%	98.4%	98.4%	98.4%	98.4%
European efficiency	97.9%	98.0%	98.1%	98.1%	98.2%

### Input

Technical Specifications	SUN2000-12K-MB0	SUN2000-15K-MB0	SUN2000-17K-MB0	SUN2000-20K-MB0	SUN2000-25K-MB0
Recommended maximum input DC power	18000 W	22500 W	25500 W	30000 W	37500 W
Maximum input voltage <sup>a</sup>	1100 V				
Maximum input current per MPPT	20 A (one PV string)/30 A (one MPPT)				
Maximum short-circuit current per MPPT	40 A				
Minimum startup voltage	200 V				
MPPT voltage range	200–1000 V				

Technical Specifications	SUN2000-12K-MB0	SUN2000-15K-MB0	SUN2000-17K-MB0	SUN2000-20K-MB0	SUN2000-25K-MB0
Full-load MPPT voltage range	370–800 V	410–800 V	440–800 V	480–800 V	530–800 V
Rated input voltage	600 V				
Maximum number of inputs	4				
Number of MPPTs	2				
Rated battery voltage	600 V DC				
Battery voltage range	600–980 V DC				
Maximum battery current	26.25 A				
Battery type	Li-ion				
Note a: The maximum input voltage is the maximum DC input voltage that the inverter can withstand. If the input voltage exceeds this value, the inverter may be damaged.					

## Output

Technical Specifications	SUN2000-12K-MB0	SUN2000-15K-MB0	SUN2000-17K-MB0	SUN2000-20K-MB0	SUN2000-25K-MB0
Rated output power	12000 W	15000 W	17000 W	20000 W	25000 W
Maximum apparent power	13200 VA	16500 VA	18700 VA	22000 VA	27500 VA

Technical Specifications	SUN2000-12K-MB0	SUN2000-15K-MB0	SUN2000-17K-MB0	SUN2000-20K-MB0	SUN2000-25K-MB0
Maximum active power ( $\cos\phi = 1$ )	13200 W	16500 W	18700 W	22000 W	27500 W
Rated output voltage	220 V/380 V, 3W/N+PE 230 V/400 V, 3W/N+PE 240 V/415 V, 3W/N+PE				
Maximum output voltage at long-term operation	Refer to the local power grid standards.				
Rated output current	18.2 A/380 V 17.3 A/400 V 16.7 A/415 V	22.8 A/380 V 21.7 A/400 V 20.9 A/415 V	25.8 A/380 V 24.5 A/400 V 23.7 A/415 V	30.4 A/380 V 28.9 A/400 V 27.8 A/415 V	38.0 A/380 V 36.1 A/400 V 34.8 A/415 V
Maximum output current	20.2 A/380 V 19.1 A/400 V 18.5 A/415 V	25.2 A/380 V 23.9 A/400 V 23.1 A/415 V	28.6 A/380 V 27.1 A/400 V 26.1 A/415 V	33.6 A/380 V 31.9 A/400 V 30.8 A/415 V	42.0 A/380 V 39.9 A/400 V 38.5 A/415 V
Output voltage frequency	50 Hz/60 Hz				
Power factor	0.8 leading ... 0.8 lagging				
Output DC component (DCI)	< 0.5% of the rated output				
Maximum total harmonic distortion (AC THDi)	< 3% under rated conditions. Single harmonic meets the VDE 4105 requirements.				



## Protection

Technical Specifications	SUN2000-12K-MB0	SUN2000-15K-MB0	SUN2000-17K-MB0	SUN2000-20K-MB0	SUN2000-25K-MB0
Overvoltage category	PV II/AC III				
Input DC switch	Supported				
Anti-islanding protection	Supported				
Output overcurrent protection	Supported				
Input reverse connection protection	Supported				
DC surge protection	TYPE II				
AC surge protection	Yes, compatible with TYPE II protection class according to EN/IEC 61643-11				
Insulation resistance detection	Supported				
Residual current monitoring unit (RCMU)	Supported				

## Display and Communication

Technical Specifications	SUN2000-12K-MB0	SUN2000-15K-MB0	SUN2000-17K-MB0	SUN2000-20K-MB0	SUN2000-25K-MB0
Display	LED indicators; WLAN+app				
WLAN-FE Dongle	Supported				
4G Smart Dongle	Optional				

Technical Specifications	SUN2000-12K-MB0	SUN2000-15K-MB0	SUN2000-17K-MB0	SUN2000-20K-MB0	SUN2000-25K-MB0
RS485 communication	Supported				
Built-in WLAN	Supported				
DC MBUS	Supported				
AFCI	Supported				
PID recovery	Supported				

## General Specifications

Technical Specifications	SUN2000-12K-MB0	SUN2000-15K-MB0	SUN2000-17K-MB0	SUN2000-20K-MB0	SUN2000-25K-MB0
Dimensions (H x W x D)	460 mm x 546 mm x 228 mm				
Net weight	21 kg				
Noise	< 45 dB (typical working condition)	< 45 dB (typical working condition)	< 45 dB (typical working condition)	< 50 dB (typical working condition)	< 50 dB (typical working condition)
Operating temperature	-25°C to +60°C				
Relative humidity	0-100% RH				
Cooling mode	Smart air cooling				
Maximum operating altitude	4000 m (derated when the altitude is greater than 2000 m)				
Storage temperature	-40°C to +70°C				
IP rating	IP66				

Technical Specifications	SUN2000-12K-MB0	SUN2000-15K-MB0	SUN2000-17K-MB0	SUN2000-20K-MB0	SUN2000-25K-MB0
Topology	Transformerless				

## Wireless Communication Parameters

Technical Specifications	Inverter Built-in WiFi	WLAN-FE Smart Dongle	4G Smart Dongle
Frequency	2400–2483.5 MHz	SDongleA-05: 2400–2483.5 MHz	SDongleB-06-EU (WiFi): 2400–2483.5 MHz SDongleB-06-EU (4G): <ul style="list-style-type: none"> <li>• Supports LTE FDD: B1/B3/B5/B8.</li> <li>• Supports LTE TDD: B7/B20/B28/B38/B40/B41.</li> <li>• Supports GSM/GPRS/EDGE: 900 MHz/1800 MHz.</li> </ul>
Protocols and standards	WLAN 802.11b/g/n	SDongleA-05: WLAN 802.11b/g/n	SDongleB-06-EU (WiFi): WLAN 802.11b/g/n SDongleB-06-EU (4G): <ul style="list-style-type: none"> <li>• Supports LTE FDD (with receive diversity): B1/B3/B5/B8.</li> <li>• Supports LTE TDD (with receive diversity): B7/B20/B28/B38/B40/B41.</li> <li>• Supports GSM: 900 MHz/1800 MHz.</li> <li>• Supports digital audio.</li> </ul>

Technical Specifications	Inverter Built-in WiFi	WLAN-FE Smart Dongle	4G Smart Dongle
Bandwidth	20 MHz/40 MHz (optional)	20 MHz/40 MHz (optional)	<p>LTE features:</p> <ul style="list-style-type: none"> <li>● Supports a maximum of 3GPP R8 non-CA Cat 4 FDD and TDD.</li> <li>● Supports 1.4 MHz/3 MHz/5 MHz/10 MHz/15 MHz/20 MHz RF bandwidth.</li> <li>● Supports MIMO in the downlink.</li> <li>● LTE FDD: maximum downlink rate of 150 Mbit/s and maximum uplink rate of 50 Mbit/s</li> <li>● LTE TDD: maximum downlink rate of 130 Mbit/s and maximum uplink rate of 30 Mbit/s</li> </ul> <p>UMTS features:</p> <ul style="list-style-type: none"> <li>● Supports 3GPP R7 HSDPA+, HSDPA, HSUPA, and WCDMA.</li> <li>● Supports QPSK and 16QAM modulation.</li> <li>● HSDPA+: maximum downlink rate of 21 Mbit/s</li> <li>● HSUPA: maximum uplink rate of 5.76 Mbit/s</li> <li>● WCDMA: maximum downlink rate of 384 kbit/s and maximum uplink rate of 384 kbit/s</li> </ul> <p>GSM features:</p> <p>GPRS:</p> <ul style="list-style-type: none"> <li>● Supports GPRS multislots class 12.</li> <li>● Coding schemes: CS-1, CS-2, CS-3, and CS-4</li> <li>● Maximum downlink rate: 85.6 kbit/s; maximum uplink rate: 85.6 kbit/s</li> </ul> <p>EDGE:</p>

Technical Specifications	Inverter Built-in WiFi	WLAN-FE Smart Dongle	4G Smart Dongle
			<ul style="list-style-type: none"> <li>• Supports EDGE multislots class 12.</li> <li>• Supports GMSK and 8-PSK modulation and coding schemes.</li> <li>• Downlink coding format: MCS 1-9</li> <li>• Uplink coding format: MCS 1-9</li> <li>• Maximum downlink rate: 236.8 kbit/s; maximum uplink rate: 236.8 kbit/s</li> </ul> SDongleB-06-EU (WiFi): 20 MHz/40 MHz (optional)
Maximum transmit power	≤ 20 dBm EIRP	≤ 20 dBm EIRP	<ul style="list-style-type: none"> <li>• Class 4 (33 dBm±2 dB), EGSM900 frequency band</li> <li>• Class 1 (30 dBm±2 dB), DCS1800 frequency band</li> <li>• Class E2 (27 dBm±3 dB), EGSM900 8-PSK</li> <li>• Class E2 (26 dBm±3 dB), DCS1800 8-PSK</li> <li>• Class 3 (24 dBm+1/-3 dB), WCDMA frequency band</li> <li>• Class 3 (23 dBm±2 dB), LTE FDD frequency band</li> <li>• Class 3 (23 dBm±2 dB), LTE TDD frequency band</li> </ul> SDongleB-06-EU (WiFi): ≤ 20 dBm EIRP

# A Grid Codes

 NOTE

The grid codes are subject to change. The listed codes are for reference only.

**Table A-1** SUN2000-(15K-25K)-MB0-ZH grid codes

No.	Grid Code	Description	SUN2000-15K-MB0-ZH	SUN2000-17K-MB0-ZH	SUN2000-20K-MB0-ZH	SUN2000-25K-MB0-ZH
1	NB/T 32004	China Golden Sun low-voltage power grid	Supported	Supported	Supported	Supported
2	Custom (50 Hz)	Reserved	Supported	Supported	Supported	Supported
3	CHINA-LV220/380	China low-voltage power grid	Supported	Supported	Supported	Supported

**Table A-2** SUN2000-(12K-25K)-MB0 grid codes

No.	Grid Code	Description	SUN2000-12K-MB0	SUN2000-15K-MB0	SUN2000-17K-MB0	SUN2000-20K-MB0	SUN2000-25K-MB0
1	VDE-AR-N-4105	Germany low-voltage power grid	Supported	Supported	Supported	Supported	Supported
2	UTE C 15-712-1(A)	France mainland power grid	Supported	Supported	Supported	Supported	Supported

No	Grid Code	Description	SUN2 000-1 2K- MB0	SUN2 000-1 5K- MB0	SUN2 000-1 7K- MB0	SUN2 000-2 0K- MB0	SUN2 000-2 5K- MB0
3	UTE C 15-712-1(B)	France island power grid	Suppo rted	Suppo rted	Suppo rted	Suppo rted	Suppo rted
4	UTE C 15-712-1(C)	France island power grid	Suppo rted	Suppo rted	Suppo rted	Suppo rted	Suppo rted
5	CEI0-21	Italy power grid	Suppo rted	Suppo rted	Suppo rted	Suppo rted	Suppo rted
6	RD1699/661	Spain low- voltage power grid	Suppo rted	Suppo rted	Suppo rted	Suppo rted	Suppo rted
7	C10/11	Belgium power grid	Suppo rted	Suppo rted	Suppo rted	Suppo rted	Suppo rted
8	IEC61727	IEC 61727 low-voltage grid- connection (50 Hz)	Suppo rted	Suppo rted	Suppo rted	Suppo rted	Suppo rted
9	Custom (50 Hz)	Reserved	Suppo rted	Suppo rted	Suppo rted	Suppo rted	Suppo rted
10	Custom (60 Hz)	Reserved	Suppo rted	Suppo rted	Suppo rted	Suppo rted	Suppo rted
11	CEI0-16	Italy power grid	Suppo rted	Suppo rted	Suppo rted	Suppo rted	Suppo rted
12	TAI-PEA	Thailand grid- connection standard	Suppo rted	Suppo rted	Suppo rted	Suppo rted	Suppo rted
13	TAI-MEA	Thailand grid- connection standard	Suppo rted	Suppo rted	Suppo rted	Suppo rted	Suppo rted
14	Philippines	Philippines low-voltage power grid	Suppo rted	Suppo rted	Suppo rted	Suppo rted	Suppo rted
15	NRS-097-2-1	South Africa power grid standard	Suppo rted	Suppo rted	Suppo rted	Suppo rted	Suppo rted

No	Grid Code	Description	SUN2000-12K-MB0	SUN2000-15K-MB0	SUN2000-17K-MB0	SUN2000-20K-MB0	SUN2000-25K-MB0
16	IEC61727-60Hz	IEC 61727 low-voltage grid-connection (60 Hz)	Supported	Supported	Supported	Supported	Supported
17	PO12.3	Spain low-voltage power grid	Supported	Supported	Supported	Supported	Supported
18	EN50549-LV	Ireland power grid	Supported	Supported	Supported	Supported	Supported
19	Jordan-Transmission	Jordan low-voltage power grid	Supported	Supported	Supported	Supported	Supported
20	ABNT NBR 16149	Brazil power grid	Supported	Supported	Supported	Supported	Supported
21	DUBAI	Dubai low-voltage power grid	Supported	Supported	Supported	Supported	Supported
22	Jordan-Distribution	Jordan power distribution network low-voltage power grid	Supported	Supported	Supported	Supported	Supported
23	TAIPOWER	Taiwan Power low-voltage power grid	Supported	Supported	Supported	Supported	Supported
24	OMAN	Oman low-voltage power grid	Supported	Supported	Supported	Supported	Supported
25	Pakistan	Pakistan power grid	Supported	Supported	Supported	Supported	Supported
26	Austria	Austria power grid	Supported	Supported	Supported	Supported	Supported
27	G99-TYPEA-LV	UK G99_TypeA_LV power grid	Supported	Supported	Supported	Supported	Supported



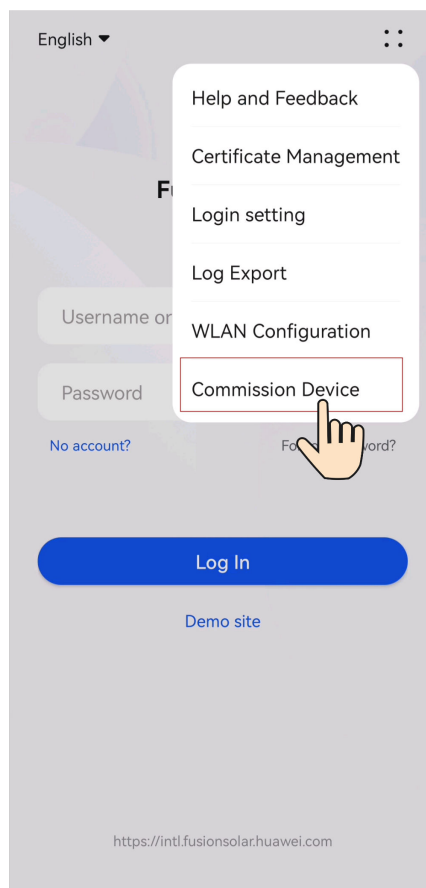
No	Grid Code	Description	SUN2 000-1 2K- MB0	SUN2 000-1 5K- MB0	SUN2 000-1 7K- MB0	SUN2 000-2 0K- MB0	SUN2 000-2 5K- MB0
28	G99-TYPEB-LV	UK G99_TypeB_ LV power grid	Suppo rted	Suppo rted	Suppo rted	Suppo rted	Suppo rted
29	EN50549- MV400	Ireland new standard	Suppo rted	Suppo rted	Suppo rted	Suppo rted	Suppo rted
30	VDE-AR- N4110	Germany medium- voltage power grid (230 V)	Suppo rted	Suppo rted	Suppo rted	Suppo rted	Suppo rted
31	NTS	Spain power grid	Suppo rted	Suppo rted	Suppo rted	Suppo rted	Suppo rted
32	SINGAPORE	Singapore low-voltage power grid	Suppo rted	Suppo rted	Suppo rted	Suppo rted	Suppo rted
33	HONGKONG	Hong Kong low-voltage power grid	Suppo rted	Suppo rted	Suppo rted	Suppo rted	Suppo rted
34	EN50549-SE	Sweden low- voltage power grid	Suppo rted	Suppo rted	Suppo rted	Suppo rted	Suppo rted
35	EN50549-PL	Poland power grid	Suppo rted	Suppo rted	Suppo rted	Suppo rted	Suppo rted
36	DENMARK- EN50549- DK1-LV230	Denmark power grid	Suppo rted	Suppo rted	Suppo rted	Suppo rted	Suppo rted
37	DENMARK- EN50549- DK2-LV230	Denmark power grid	Suppo rted	Suppo rted	Suppo rted	Suppo rted	Suppo rted
38	SWITZERLAND -NA/ EEA:2020- LV230	Switzerland power grid	Suppo rted	Suppo rted	Suppo rted	Suppo rted	Suppo rted
39	AUSTRALIA- AS4777_A- LV230	Australia power grid	Suppo rted	Suppo rted	Suppo rted	Suppo rted	Suppo rted

No	Grid Code	Description	SUN2 000-1 2K- MB0	SUN2 000-1 5K- MB0	SUN2 000-1 7K- MB0	SUN2 000-2 0K- MB0	SUN2 000-2 5K- MB0
40	AUSTRALIA- AS4777_B- LV230	Australia power grid	Supp orted	Suppo rted	Suppo rted	Suppo rted	Suppo rted
41	AUSTRALIA- AS4777_C- LV230	Australia power grid	Supp orted	Suppo rted	Suppo rted	Suppo rted	Suppo rted
42	AUSTRALIA- AS4777_NZ- LV230	Australia power grid	Supp orted	Suppo rted	Suppo rted	Suppo rted	Suppo rted
43	NA_CODE	Default country code	Supp orted	Suppo rted	Suppo rted	Suppo rted	Suppo rted
44	CZECH- EN50549- LV230	Czech Republic power grid	Supp orted	Suppo rted	Suppo rted	Suppo rted	Suppo rted

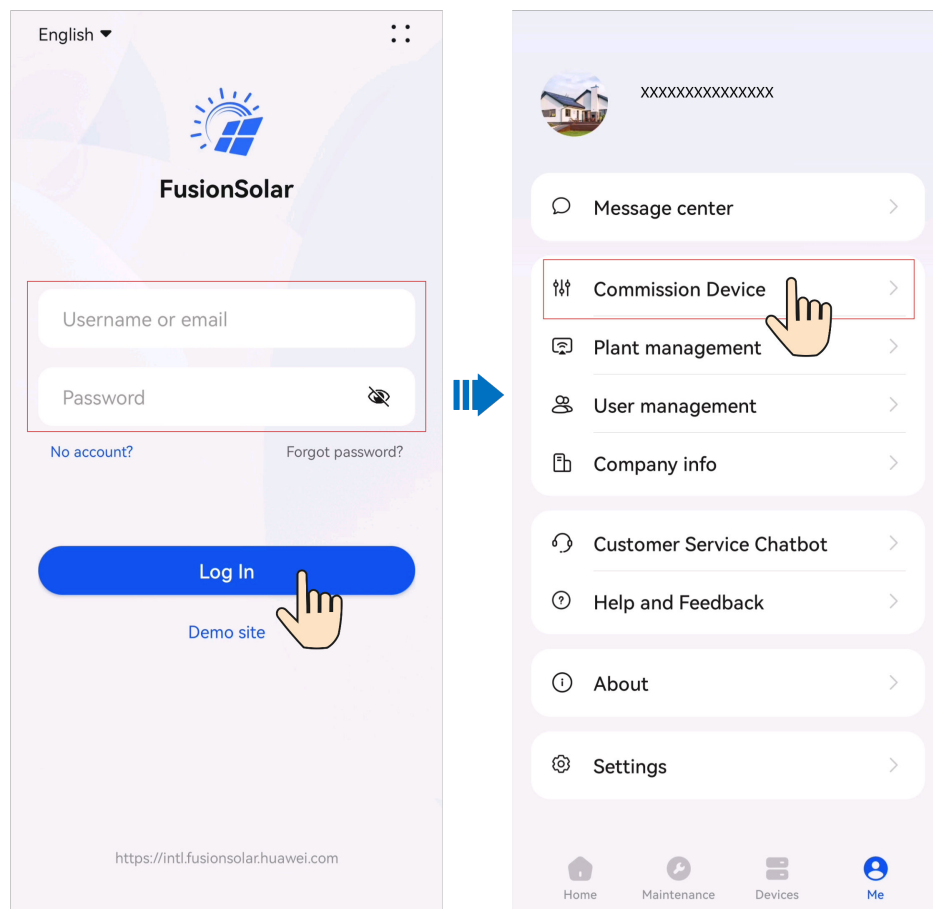
# B Connecting to the Inverter

**Step 1** Access the **Commission Device** screen.

**Figure B-1** Method 1: before login (not connected to the Internet)



**Figure B-2** Method 2: after login (connected to the Internet)



**Step 2** Connect to the inverter WLAN and log in to the **Commission Device** screen as the installer user.

#### NOTICE

- If the mobile phone is directly connected to the SUN2000, the visible distance between the SUN2000 and the mobile phone must be less than 3 m when a built-in antenna is used and less than 50 m when an external antenna is used to ensure the communication quality between the App and the SUN2000. The distances are for reference only and may vary with mobile phones and shielding conditions.
- When connecting the SUN2000 to the WLAN over a router, ensure that the mobile phone and SUN2000 are in the WLAN coverage of the router and the SUN2000 is connected to the router.
- The router supports WLAN (IEEE 802.11 b/g/n, 2.4 GHz) and the WLAN signal reaches the SUN2000.
- The WPA, WPA2, or WPA/WPA2 encryption mode is recommended for routers. Enterprise-level encryption is not supported (for example, public hotspots requiring authentication such as airport WLAN). WEP and WPA TKIP are not recommended because these two encryption modes have serious security defects. If the access fails in WEP mode, log in to the router and change the encryption mode of the router to WPA2 or WPA/WPA2.

 **NOTE**

- Obtain the initial password for connecting to the solar inverter WLAN from the label on the side of the solar inverter.
- Set the password at the first login. To ensure account security, change the password periodically and keep the new password in mind. Not changing the initial password may cause password disclosure. A password left unchanged for a long period of time may be stolen or cracked. If a password is lost, devices cannot be accessed. In these cases, the user is liable for any loss caused to the PV plant.
- When you access the **Commission Device** screen of the inverter for the first time, you need to manually set the login password because the inverter does not have an initial login password.

----End

# C Connecting to the EMMA

**Step 1** Access the **Commission Device** screen.

**Figure C-1** Method 1: before login (not connected to the Internet)

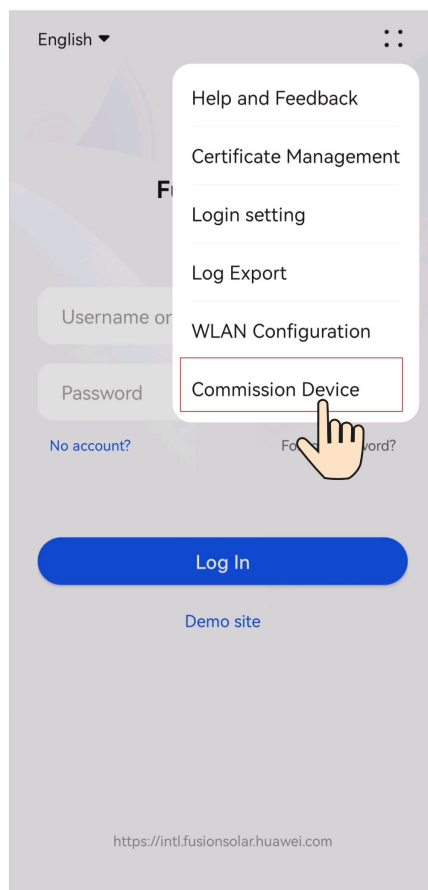
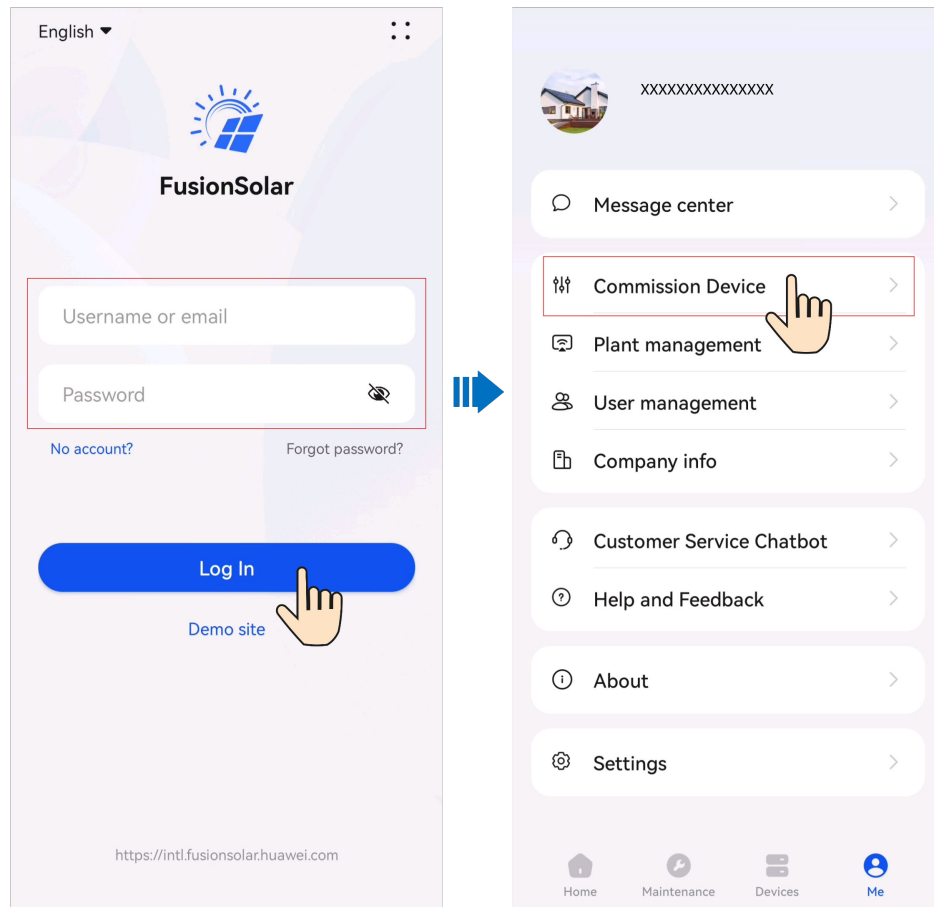


Figure C-2 Method 2: after login (connected to the Internet)



**Step 2** Connect to the EMMA WLAN and log in to the **Commission Device** screen as the installer user.





**NOTE**

- The last six digits of the product WLAN name are the same as the last six digits of the product SN.
- For the first connection, log in with the initial password. You can obtain the initial password from the label on the device.
- To ensure account security, protect the password by changing it periodically, and keep it secure. Your password might be stolen or cracked if it is left unchanged for extended periods. If a password is lost, devices cannot be accessed. In these cases, the Company shall not be liable for any loss.
- If the login screen is not displayed after you scan the QR code, check whether your phone is correctly connected to the device WLAN. If not, manually select and connect to the WLAN, and tap **Next**.
- If the **This WLAN network has no Internet access. Connect anyway?** message is displayed when you connect to the built-in WLAN, tap **CONNECT**. Otherwise, you cannot log in to the system. The actual UI and messages may vary with mobile phones.

----End

# D Resetting Password

---

- Step 1** Check that the AC and DC sides of the inverter are both powered on, and indicators  and  are steady green or blinking slowly for more than 3 minutes.
- Step 2** Turn off the AC switch, set the DC SWITCH at the bottom of the inverter to OFF, and wait until all indicators on the inverter panel turn off.
- Step 3** Complete the following operations within 4 minutes:
1. Turn on the AC switch and wait for about 90s or until the inverter indicator  blinks.
  2. Turn off the AC switch and wait about 30s or until all LED indicators on the inverter panel turn off.
  3. Turn on the AC switch and wait for about 30s or until all LED indicators on the inverter panel blink and then turn off after about 30s.
- Step 4** Wait until the three green LEDs on the inverter panel blink fast and then the three red LEDs blink fast, which indicates that the password is restored.
- Step 5** Reset the password within 10 minutes. (If no operation is performed within 10 minutes, all parameters of the inverter remain unchanged.)
1. Wait until the indicator  blinks.
  2. Connect to the app using the initial WLAN hotspot name (SSID) and initial password (PSW), which can be obtained from the label on the side of the inverter.
  3. On the login page, set a new password and log in to the app.
- Step 6** Set router and management system parameters to implement remote management.

----End

---

## NOTICE

You are advised to reset the password in the morning or at night when the solar irradiance is low.

---



# E Rapid Shutdown

---

## NOTE

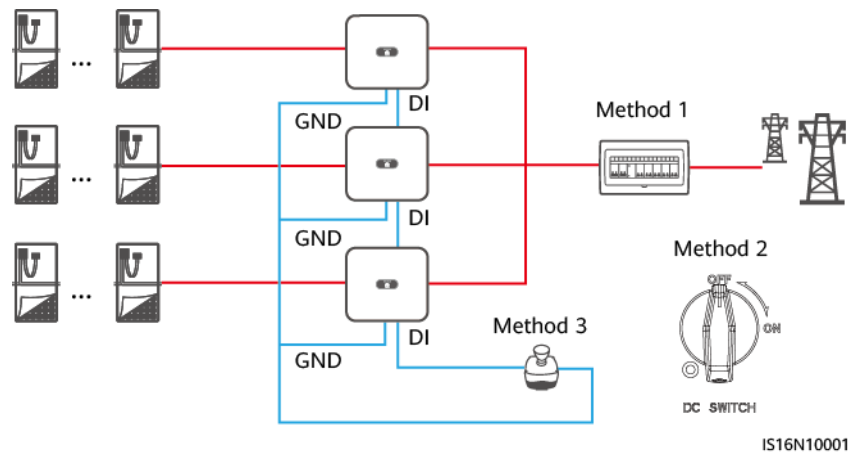
- If method 3 is selected for rapid shutdown, log in to the FusionSolar app as an **installer** user to perform local commissioning, choose **Settings > Feature parameters > Dry contact function**, and set **Dry contact function** to **DI rapid shutdown**.

If optimizers are configured for all PV modules, the PV system can perform a rapid shutdown to decrease the output voltage to below 30 V within 30s.

Perform the following steps to trigger a rapid shutdown:

- Method 1: Turn off the AC switch between the inverter and the power grid (disconnect the voltages of all PV strings connected to the inverter under the AC switch).
- Method 2: Set the **DC SWITCH** of the inverter to **OFF** to trigger a rapid shutdown. The inverter shuts down several minutes later. (Turning off all external switches on the DC side of an inverter can trigger a rapid shutdown, and only the PV strings connected to the inverter is de-energized. Turning off only some external switches cannot trigger a rapid shutdown, and the PV strings may be energized.)
- Method 3: To enable the DI rapid shutdown function, connect a switch to pins DI and GND of the inverter communications terminal. The switch is turned on by default. Turn off the switch to trigger a rapid shutdown. The distance between the switch and the farthest inverter must be less than or equal to 10 m.
- Method 4: If **AFCI** is enabled, the inverter automatically performs arc fault detection and triggers a rapid shutdown when AFCI lock protection is implemented.

**Figure E-1** Methods of triggering a rapid shutdown



# F Baud Rate Negotiation

Baud rate negotiation increases the communications rate between the inverter and devices such as batteries and power meters, and between the inverter and devices such as the Smart Dongles and the EMMA, solving or relieving communication congestion.

- During device search in a new plant, the system automatically negotiates the baud rate.
- When replacing or adding inverters, batteries, power meters, the Smart Dongle, or the EMMA at an existing plant, you need to manually send local commands on the FusionSolar app to reset the baud rate between devices and negotiate a higher rate.

 **NOTE**

Users can send the baud rate negotiation commands on the FusionSolar app in two networking modes: EMMA networking and Smart Dongle networking.

**Table F-1** Manual baud rate negotiation on the app

Networking Mode	Scenario	Operation
EMMA networking	Replacing the EMMA	<ol style="list-style-type: none"> <li>1. Use the FusionSolar app to locally scan the QR code to connect to the EMMA.</li> <li>2. Access the <b>Communication settings</b> screen, choose <b>RS485 Settings &gt; Baud Rate Negotiation</b>, and tap <b>9600</b> and <b>Negotiate a higher rate</b>.</li> </ol>

Networking Mode	Scenario	Operation
	Replacing or adding an inverter	<ol style="list-style-type: none"> <li>1. Use the FusionSolar app to locally scan the QR code to connect to the EMMA.</li> <li>2. Access the <b>Communication settings</b> screen, choose <b>RS485 Settings &gt; Baud Rate Negotiation</b>, and tap <b>9600</b> and <b>Negotiate a higher rate</b>.</li> <li>3. Use the FusionSolar app to locally scan the QR code to connect to the inverter.</li> <li>4. Access the <b>Communication configuration</b> screen, choose <b>RS485 &gt; Baud Rate Negotiation &gt; RS485_2 &gt; Baud Rate Negotiation</b>, and tap <b>9600</b> and <b>Negotiate a higher rate</b>.</li> </ol>
	Replacing or adding an RS485_2 device (such as a battery or power meter)	<ol style="list-style-type: none"> <li>1. Use the FusionSolar app to locally scan the QR code to connect to the inverter.</li> <li>2. Access the <b>Communication configuration</b> screen, choose <b>RS485 &gt; Baud Rate Negotiation &gt; RS485_2 &gt; Baud Rate Negotiation</b>, and tap <b>9600</b> and <b>Negotiate a higher rate</b>.</li> </ol>
Smart Dongle networking	Replacing the Smart Dongle	<ol style="list-style-type: none"> <li>1. Use the FusionSolar app to locally scan the QR code to connect to the inverter.</li> <li>2. Access the <b>Communication configuration</b> screen, choose <b>RS485 &gt; Baud Rate Negotiation &gt; RS485_1 &gt; Baud Rate Negotiation</b>, and tap <b>9600</b> and <b>Negotiate a higher rate</b>.</li> </ol>
	Replacing or adding an inverter	<ol style="list-style-type: none"> <li>1. Use the FusionSolar app to locally scan the QR code to connect to the inverter.</li> <li>2. Access the <b>Communication configuration</b> screen, choose <b>RS485 &gt; Baud Rate Negotiation &gt; RS485_1 &gt; Baud Rate Negotiation</b>, and tap <b>9600</b> and <b>Negotiate a higher rate</b>.</li> <li>3. Access the <b>Communication configuration</b> screen, choose <b>RS485 &gt; Baud Rate Negotiation &gt; RS485_2 &gt; Baud Rate Negotiation</b>, and tap <b>9600</b> and <b>Negotiate a higher rate</b>.</li> </ol>

Networking Mode	Scenario	Operation
	Replacing or adding an RS485_2 device (such as a battery or power meter)	<ol style="list-style-type: none"> <li>1. Use the FusionSolar app to locally scan the QR code to connect to the inverter.</li> <li>2. Access the <b>Communication configuration</b> screen, choose <b>RS485 &gt; Baud Rate Negotiation &gt; RS485_2 &gt; Baud Rate Negotiation</b>, and tap <b>9600</b> and <b>Negotiate a higher rate</b>.</li> </ol>

## Troubleshooting

If manual baud rate negotiation fails, refer to the following troubleshooting measures.

**Table F-2** Troubleshooting measures

Scenario	Troubleshooting
Negotiation failed	<ol style="list-style-type: none"> <li>1. Check whether the device cables are connected properly. If no, connect the device cables correctly.</li> <li>2. Check whether service operations such as upgrade and log export are performed on the management system. If yes, perform baud rate negotiation again after such operations are complete.</li> <li>3. To replace an RS485_2 device (such as a battery or power meter), choose <b>Maintenance &gt; Subdevice management</b> on the home screen, touch and hold the replaced RS485_2 device to delete it.</li> <li>4. Perform baud rate negotiation again.</li> <li>5. When replacing or adding an inverter or an RS485_2 device (such as a battery or power meter), if you tap <b>Negotiate a higher rate</b> and a message "Negotiation failed. The southbound device does not support the rate." is displayed, it indicates that the device does not support baud rate negotiation. In this case, you only need to tap <b>9600</b>.</li> <li>6. If the fault persists, contact your vendor.</li> </ol>

# G Contact Information

---

If you have any questions about this product, please contact us.



<https://digitalpower.huawei.com>

Path: **About Us > Contact Us > Service Hotlines**

To ensure faster and better services, we kindly request your assistance in providing the following information:

- Model
- Serial number (SN)
- Software version
- Alarm ID or name
- Brief description of the fault symptom

 **NOTE**

EU Representative Information: Huawei Technologies Hungary Kft.  
Add.: HU-1133 Budapest, Váci út 116-118., 1. Building, 6. floor.  
Email: hungary.reception@huawei.com

# H Digital Power Customer Service

---



<https://digitalpower.huawei.com/robotchat/>



# Certificate Management and Maintenance

## I.1 Preconfigured Certificate Risk Disclaimer

The Huawei-issued certificates preconfigured on Huawei devices during manufacturing are mandatory identity credentials for Huawei devices. The disclaimer statements for using the certificates are as follows:

1. Preconfigured Huawei-issued certificates are used only in the deployment phase, for establishing initial security channels between devices and the customer's network. Huawei does not promise or guarantee the security of preconfigured certificates.
2. The customer shall bear consequences of all security risks and security incidents involved in using preconfigured Huawei-issued certificates as service certificates.
3. A preconfigured Huawei-issued certificate is valid until October 11, 2041 starting from the manufacturing date.
4. Services using a preconfigured Huawei-issued certificate will be interrupted when the certificate expires.
5. It is recommended that customers deploy a PKI system to issue certificates for devices and software on the live network and manage the lifecycle of the certificates. To ensure security, certificates with short validity periods are recommended.

### NOTE

You can view the validity period of a preconfigured certificate on the network management system.

## I.2 Application Scenarios of Preconfigured Certificates

File Path and Name	Scenario	Replacement
f:/sun_ca.crt	Authenticates the validity of the peer mobile app for communication through Modbus TCP.	For details about how to replace a certificate, contact technical support engineers to obtain the corresponding security maintenance manual.  Certificates for communication between the Company's products can be replaced.
f:/sun_tomcat_client.crt		
f:/sun_tomcat_client.key		

---

# J Acronyms and Abbreviations

---

<b>A</b>	
<b>AFCI</b>	Arc-fault Circuit Interrupter
<b>L</b>	
<b>LED</b>	Light Emitting Diode
<b>M</b>	
<b>MPP</b>	Maximum Power Point
<b>MPPT</b>	Maximum Power Point Tracking
<b>P</b>	
<b>PE</b>	Protective Earthing
<b>PID</b>	Potential Induced Degradation
<b>PV</b>	Photovoltaic
<b>R</b>	
<b>RH</b>	Relative Humidity
<b>S</b>	
<b>SOC</b>	State of Charge