



PROTOTYPE DECLARATION / Prototypenbescheinigung

Product prototype certificate number
For the company: / Für das Unternehmen

No:2620/0350-PTCER

SMA Solar Technology AG.
Sonnenallee, 1.34266. Niestetal. Germany.

Has provided to E&E Product Certification Body of SGS the technical documentation indicated in both articles no. 12 of standards /

Hat der E & E-Produktzertifizierungsstelle von SGS die technischen Dokumente für beide Artikel-Nr. 12 des Standards überliefert:

- **VDE-AR-N 4110: 2018.** Technical requirements for the connection and operation of customer installations to the medium voltage network (TAR medium voltage) / *VDE-AR-N 4110: 2018. Technische Voraussetzungen für den Anschluss und Betrieb von Kundenanlagen an das Mittelspannungsnetz (TAR-Mittelspannung).*
- **VDE-AR-N 4120:2018.** Technical requirements for the connection and operation of customer installations to the high voltage network (TAR high voltage). *VDE-AR-N 4120: 2018.. Technische Voraussetzungen für den Anschluss und Betrieb von Kundeninstallationen an das Hochspannungsnetz (TAR-Hochspannung).*

For the product / Für das Produkt: **Typ 2 PV Grid-Connected Inverter / Typ 2 PV-Wechselrichter**

Models / Modelle:		STP 110-60
Technical Data / Technische Daten:		
DC	Max. PV input voltage / Max. PV-Eingangsspannung:	1100 V
	MPP Voltage Range / MPP-Spannungsbereich:	200 – 1000 V
	N° of MPP inputs / Anzahl MPP-Eingänge:	12
	Max. PV input current / Max. PV-Eingangsstrom:	26 A x 12
AC	AC output power/ AC-Ausgangsleistung:	110 kVA
	Max. AC output current / Max. AC-Ausgangsstrom:	158,8 A
	Nominal Grid Voltage / Nominale Netzspannung:	3 / PE, 400 V
	AC voltage range / Wechselspannungsbereich:	320 – 460 V
	Nominal Grid Frequency / Nominale Netzfrequenz:	50 / 60 Hz
Software version / Softwareversion		1.00.00R

We confirm that the above mentioned PV inverters are considered as Prototypes in accordance with the VDE-AR-N 4110, the VDE-AR-N 4120 and the standard FGW TR 8 / *Hiermit bestätigen wir, dass es sich bei der genannten EZE nach VDE-AR-N 4110, VDE-AR-N 4120 und FGW TR 8 um einen Prototyp handelt*

- **FGW TR8. Certification of the Electrical Characteristics of Power Generating Units, Systems and Storage Systems as well as for their Components to the Grid. Revision 9.**
FGW TR8. Zertifizierung der elektrischen Eigenschaften von Erzeugungseinheiten und -anlagen, Speicher sowie für deren Komponenten am Stromnetz. Revision 9.

Test reports and certificates will be issued when the testing process is finished and evaluated with positive result.
Testberichte und Zertifikate werden nach Abschluss des Testprozesses ausgestellt und mit positivem Ergebnis bewertet.

Brussels, 17th of July 2020

Calogero Lana
Certification Manager /
Zertifizierungsmanager

Annex 1 / Anhang 1

This certificate confirms that the mentioned generation unit is a prototype according to FGW TR 8. For this purpose, the PGU is described below and the main technical developments or innovations are presented: /

Diese Bescheinigung bestätigt, dass es sich bei der genannten Erzeugungseinheit nach FGW TR 8 um einen Prototypen handelt. Dazu wird im Folgenden die EZE beschrieben und die wesentlichen technischen Weiterentwicklungen oder Neuerungen dargestellt:

Description of the generating unit / Beschreibung der Erzeugungseinheit:

The photovoltaic generation unit (PV-PGU) enables the supply of direct current generated by means of photovoltaic modules from solar radiation into the public alternating current grid using power electronics. /

Die Photovoltaikerzeugungseinheit (PV-EZE) ermöglicht die Einspeisung von Gleichstrom erzeugt mittels Photovoltaikmodulen aus solarer Einstrahlung in das öffentliche Wechselstromnetz unter Verwendung von Leistungselektronik.

Treatment according to FGW TR 8, 2.3.2.2 / Behandlung nach FGW TR 8, 2.3.2.2:

The mentioned PGU is a non-wind generation unit. The plant certificate must be issued two years after the commissioning of the first PGU at the latest. /

Bei der genannten EZE handelt es sich um eine Nicht-Wind-Erzeugungseinheit. Spätestens zwei Jahre nach der Inbetriebnahme der ersten EZE muss das Anlagenzertifikat erstellt werden.

The PGU is operated in an PGS (generation plant), which consists of an PGU with PGU certificate and prototypes (case 2). Manufacturer's data must be compiled and provided for certification of the plant. The final plant certificate is issued when the PGU certificate is available for the generation unit in question. /

Die EZE wird in einer EZA (Erzeugungsanlage) betrieben, welche aus EZE mit EZE-Zertifikat und Prototypen besteht (Fall 2). Herstellerangaben müssen erstellt und für die Zertifizierung der Anlage zur Verfügung gestellt werden. Das endgültige Anlagenzertifikat wird erstellt, wenn das EZE-Zertifikat für die genannte Erzeugungseinheit vorliegt.

Annex 2 / Anhang 2

This certificate confirms that the mentioned generation unit is a prototype according to FGW TR 8. For this purpose, the PGU is described below and the main technical developments or innovations are presented: /

Diese Bescheinigung bestätigt, dass die genannte Erzeugungseinheit (EZE) in der Lage ist, die Anforderungen an die elektrischen Eigenschaften der Erzeugungseinheit nach VDE-AR-N 4110 und VDE-AR-N 4120 zu erfüllen. Dazu wird im Folgenden die Übereinstimmung der elektrischen Eigenschaften der EZE mit den Anforderungen nach VDE-ARN 4110 und VDE 4120 nachgewiesen:

VDE-AR-N 4110 & VDE-AR-N 4120	Comment and reference / Kommentar und Bewertung
<p>12 Regulation for prototypes / Prototypen-Regelung</p>	
<p>A prototype is the first power generating unit of a type presenting substantial technological developments or innovations and all other power generating units of this type put into operation within two years after the commissioning of the first power generating unit of this type. / <i>Ein Prototyp ist die erste Erzeugungseinheit eines Typs, der wesentliche technische Weiterentwicklungen oder Neuerungen aufweist, und alle weiteren Erzeugungseinheiten dieses Typs, die innerhalb von zwei Jahren nach der Inbetriebsetzung der ersten Erzeugungseinheit dieses Typs in Betrieb gesetzt werden.</i></p> <p>NOTE 1 This definition corresponds to the term's definition given in SDLWindV. There is no relation to the term "pilot wind turbine" (de: Pilotwindenergieanlage) used in the EEG. / <i>ANMERKUNG 1 Diese Definition entspricht der Begriffsdefinition nach SDLWindV. Es besteht kein Zusammenhang zum Begriff „Pilotwindenergieanlage“ im EEG [6].</i></p> <p>Technological developments and innovations are generally considered to be substantial where components or software versions are changed so that the electrical behaviour of the power generating unit at the network changes significantly and a unit certification of this new type is required. / <i>Wesentliche technische Weiterentwicklungen und Neuerungen liegen in der Regel vor, wenn Komponenten oder Softwareversionen so geändert werden, dass sich das elektrische Verhalten der Erzeugungseinheit am Netz signifikant ändert und eine Einheitszertifizierung dieses neuen Typs erforderlich wird.</i></p>	<p>Checked / Berücksichtigt:</p> <ul style="list-style-type: none"> - See annex 1 / siehe Anhang 1
<p>For the prototype of a power generating unit the requirements of this VDE application guide apply. For these prototypes, a prototype confirmation, in which the certification body confirms a substantial technological development or innovation based on a manufacturer declaration, is sufficient, instead of the unit certificate, for a period of two years after commissioning of the first power generating unit prototype in Germany. The certification body shall also check and set out reproducibly in the prototype confirmation, whether the prototype is generally capable of meeting the requirements of this VDE application guide for the electrical properties of the power generating unit. This is based on an electrical properties data sheet prepared by the manufacturer of the power generating unit. / <i>Für einen Prototypen einer Erzeugungseinheit gelten die Anforderungen dieser VDE-Anwendungsregel. Innerhalb von zwei Jahren nach der Inbetriebsetzung der ersten Prototypen-Erzeugungseinheit in Deutschland ist für diese Prototypen anstelle des Einheitszertifikats eine Prototypenbestätigung ausreichend, in der die Zertifizierungsstelle das Vorhandensein einer wesentlichen technischen Weiterentwicklung oder Neuerung auf Basis einer Herstellererklärung bestätigt. Weiterhin ist durch die Zertifizierungsstelle zu prüfen und in der Prototypenbestätigung nachvollziehbar auszuweisen, ob der Prototyp grundsätzlich in der Lage ist, die Anforderungen dieser VDE-Anwendungsregel an die elektrischen Eigenschaften der Erzeugungseinheit zu erfüllen. Dies erfolgt auf Basis eines vom Hersteller der Erzeugungseinheit erstellten Datenblattes der elektrischen Eigenschaften.</i></p> <p>For prototypes commissioned before 2019-04-27, the above-mentioned period starts 2019-04-27. / <i>Für Prototypen die vor dem 27.04.2019 in Betrieb gesetzt werden, beginnt die oben genannte Frist am 27.04.2019.</i></p>	<p>Checked / Berücksichtigt</p>

VDE-AR-N 4110 & VDE-AR-N 4120	Comment and reference / Kommentar und Bewertung
<p>In order to allow the certification body to carry out the required plausibility test, the data sheet of the power generating unit shall contain at least the following information: <i>Damit die geforderte Plausibilitätsprüfung durch die Zertifizierungsstelle erfolgen kann, muss das Datenblatt der Erzeugungseinheit mindestens folgende Angaben enthalten:</i></p>	<p>Checked / <i>Berücksichtigt</i> After documentation provided by the manufacturer (see annex 3 and Annex 4). / <i>Daten vom Hersteller stehen zur Verfügung (siehe Anhang 3 und Anhang 4).</i></p>
<p>1. Electrical data (nominal and rated quantities) / <i>Elektrische Daten (Nenn- und Bemessungsgrößen);</i></p>	<p>Compliant / <i>Erfüllt:</i> - See annex 3 / <i>siehe Anhang 3</i></p>
<p>2. Schematic overview circuit diagram of the power generating unit with all relevant componentsschematisches / <i>Übersichtsbilcl der Erzeugungseinheit mit allen wesentlichen Komponenten.</i></p>	<p>Compliant / <i>Erfüllt:</i> - See annex 4 / <i>siehe Anhang 4</i></p>
<p>3. Operating ranges of the power generating unit / <i>Betriebsbereiche der Erzeugungseinheit:</i></p> <ul style="list-style-type: none"> • Limits in quasi-static operation / <i>Grenzen im quasistationären Betrieb.</i> • Reactive power adjustment range / <i>Blindleistungsstellbereich.</i> • FRT limit curve (U/t diagram) / <i>FRT-Grenzkurve(U/t-Diagramm).</i> 	<p>Compliant / <i>Erfüllt:</i> - See annex 4 / <i>siehe Anhang 4</i></p>
<p>4. Protection functions with setting ranges / <i>Schutzfunktionen mit Einstellberemhen:</i></p> <ul style="list-style-type: none"> • Decoupling protection / <i>Entkuppungsschutz.</i> • Self-protection / <i>Eigenschutz.</i> 	<p>Compliant / <i>Erfüllt:</i> - See annex 4 / <i>siehe Anhang 4</i></p>
<p>5. Active power control / <i>Wirkleistungsregelung:</i></p> <ul style="list-style-type: none"> • Power/frequency behaviour / <i>Leistungs-Freqbenz-Verhalten.</i> • Active power gradient / <i>Wirkleistungsgradient.</i> 	<p>Compliant / <i>Erfüllt:</i> - See annex 4 / <i>siehe Anhang 4</i></p>
<p>6. Reactive power control / <i>Blindleistungsregelung.</i></p>	<p>Compliant / <i>Erfüllt:</i> - See annex 4 / <i>siehe Anhang 4</i></p>
<p>7. Dynamic reactive current feed-in / <i>Dynamische Blindstromspeisung:</i></p> <ul style="list-style-type: none"> • Basic functionality / <i>Grundsätzliche Funktionsweise.</i> 	<p>Compliant / <i>Erfüllt:</i> - See annex 4 / <i>siehe Anhang 4</i></p>
<p>8. Declaration of the manufacturer stating that the power generating unit has been designed so that the requirements of this application guide for the power generating unit can be complied with / <i>Erklärung des Herstellers, dass die Erzeugungseinheit so konstruiert wurde, dass die Anforderungen dieser Anwendungsregel an die Erzeugungseinheit erfüllt werden können.</i></p>	<p>Compliant / <i>Erfüllt:</i> - See annex 4 / <i>siehe Anhang 4</i></p>
<p>At the latest after expiry of the above-mentioned period, a unit certificate is required. / <i>Spätestens nach Ablauf der oben genannten Frist ist ein Einheitenzertifikat erforderlich.</i></p> <p><i>NOTE 2 If the unit certificate is available prior to expiry of the two-year term after commissioning the first power generating unit of this type, it can still be a prototype. /</i> <i>ANMERKUNG 2 Sofern das Einheitenzertifikat vor Ablauf der Frist von zwei Jahren nach der Inbetriebsetzung der ersten Erzeugungseinheit.</i></p>	<p>Compliant / <i>Erfüllt</i></p>

Annex 3 / Anhang 3

Datasheet of the generating unit / *Datenblatt der Erzeugungseinheit:*

Type designation	STP 110-60
Input (DC)	
Max. PV input voltage	1100 V
Min. PV input voltage / Startup input voltage	200 V / 250 V
Nominal PV input voltage	585 V
MPP voltage range	200 V - 1000 V
MPP voltage range for nominal power	500V - 800 V
No. of independent MPP inputs	12
Max. number of PV strings per MPPT	2
Max. PV input current	26 A * 12
Max. DC short-circuit current	40 A * 12
Output (AC)	
AC output power	110 kVA @ 45 °C
Max. AC output current	158.8 A
Nominal AC voltage	3 / PE, 400 V
AC voltage range	320 – 460 V
Nominal grid frequency / Grid frequency range	50 Hz / 45 – 55 Hz, 60 Hz / 55 – 65 Hz
THD	< 3 % (at nominal power)
DC current injection	≤ 0.5 % I _n
Power factor at nominal power / Adjustable power factor	> 0.99 / 0.8 leading – 0.8 lagging
Feed-in phases / connection phases	3 / 3
Efficiency	
Max. efficiency	98.60%
Euro. Efficiency	98.40%
Protection	

DC reverse connection protection	Yes
AC short circuit protection	Yes
Leakage current protection	Yes
Grid monitoring	Yes
Ground fault monitoring	Yes
DC switch	Yes
PV String current monitoring	Yes
Overvoltage protection	DC Type II / AC Type II
General Data	
Dimensions (W*H*D)	1117*682*363 mm
Weight	93.5 kg
Isolation method	Transformerless
Ingress protection rating	IP66
Corrosivity class	C5
Night power consumption	< 4.5W
Operating ambient temperature range	-30 to 60 °C
Allowable relative humidity range (non-condensing)	0 – 100 %
Cooling method	Smart forced air cooling
Max. operating altitude	4000 m (> 3000 m derating)
Display	LED
Communication	Ethernet Ports x 2
DC connection type	SUNCLIX (Max. 6 mm ²)

Annex 4 / Anhang 4

Technical data of the generating unit / *Technische Daten der Erzeugungseinheit:*

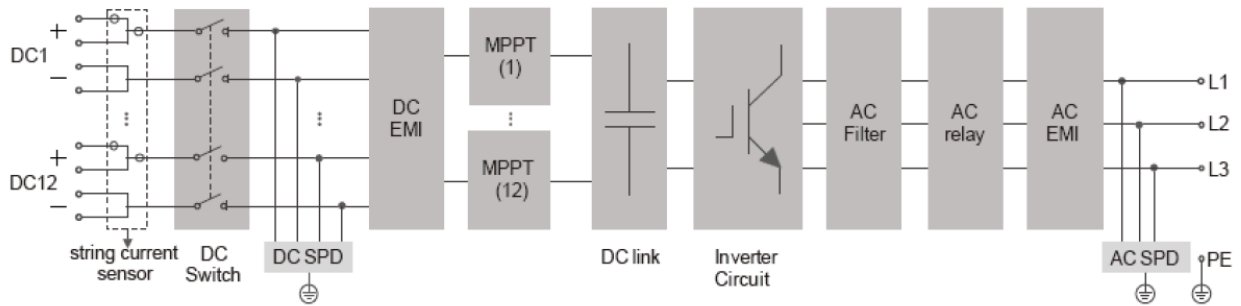

When first start PV inverter STP 110-60, there will be an initial setting for country and corresponding grid type connected

After enter into 'Germany' for Germany setting, then choose the grid type as:

Medium voltage for VDE-AR-N 4110

High voltage for VDE-AR-N 4120

0 1 2 3 4 5



4. Operational areas of STP 110-60

a) Limits during quasi-stationary operation

For both VDE-AR-N 4110 and 4120, in the entire frequency range from 47.5 Hz to 51.5 Hz and voltages in the range of 85% U_n to 115% U_n at the STP 110-60 PV inverter AC connection terminal, while voltage gradient $<5\% U_c / \text{min}$ and a frequency gradient of $<0.5\% f_n / \text{min}$, for quasi-stationary operation, STP 110-60 PV inverter is able to in parallel operation with grid according to the minimum duration time Figure 3 below.

When voltage changes at the inverter AC terminal in the amount of $\Delta U \leq 10\% U_c$ with voltage gradients of $\geq 5\% U_c / \text{min}$ within the voltage band from 90% U_c to 110% U_c occur, inverter has no reduction for active and reactive power and keep connected to the grid.

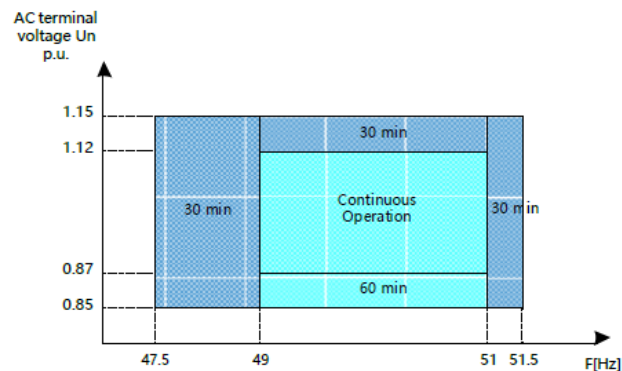

Figure 3 Quasi-stationary operation range for STP 110-60

b) Reactive power capability

For both VDE-AR-N 4110 and 4120, the reactive power capability of STP 110-60 PV inverter is according to Figure 4 below.

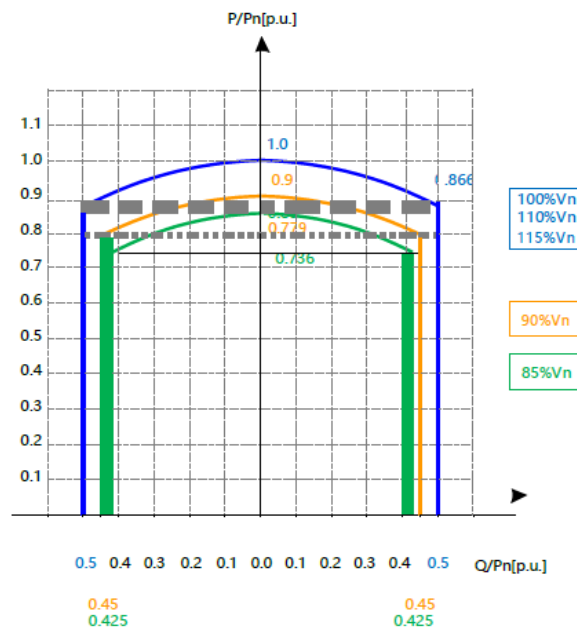

Figure 4 Voltage-dependent PQ diagram for STP 110-60

c) FRT-limit curve (U(t)-diagram)

For both VDE-AR-N 4110 and 4120, the FRT limit curve of STP 110-60 PV inverter is according to Figure 5 below.

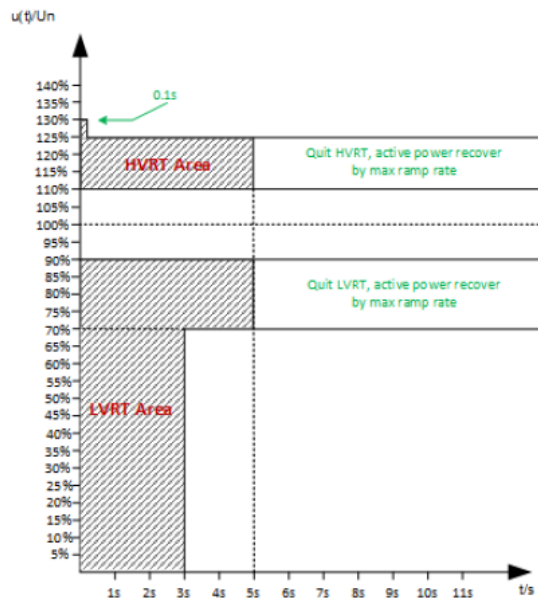

Figure 5 FRT limit curve for STP 110-60

Note: For the reason of limited dynamic grid support requirement, STP 110-60 provide ZP (Zero Power) mode as well, when select this mode, STP 110-60 will supply no active and reactive power during LVRT for the voltage drop $\leq 70\%U_n$, but for voltage range from $70\% \sim 90\%U_n$, even choose ZP mode, inverter will enter into normal LVRT period with reactive power supplied by K factor.

5. Protection functions:

a) Grid protection

The default grid protection of STP 110-60 for VDE-AR-N 4110:2018 is according to Table 1 below:

Function	Protection value	Trip time
U>	Default: 1.25 Un Range: 1.0-1.4Un	Default: 100 ms Range: 0-600000ms
U>>	Default: 1.25 Un Range: 1.0-1.4Un	Default: 100 ms Range: 0-600000ms
U<	Default: 0.80 Un Range: 0.1-1.0Un	Default: 1.0 s Range: 0-600000ms
U<<	Default: 0.45 Un Range: 0.1-1.0Un	Default: 300 ms Range: 0-600000ms
f>>	Default: 52.5 Hz Range: 50.11-55.0Hz	Default: 100 ms Range: 0-600000ms
f>	Default: 51.5 Hz Range: 50.11-55.0Hz	Default: 5 s Range: 0-600000ms
f<	Default: 47.5 Hz	Default: 100 ms
	Range: 45.0-49.88Hz	Range: 0-600000ms

Table 1 STP 110-60 default protection setting for VDE-AR-N4110:2018

The default grid protection of STP 110-60 for VDE-AR-N 4120:2018 is according to Table 2 below:

Function	Protection value	Trip time
U>>	Default: 1.25 Un Range: 1.0-1.4Un	Default: 100 ms Range: 0-600000ms
U>	Default: 1.25 Un Range: 1.0-1.4Un	Default: 100 ms Range: 0-600000ms
U<	Default: 0.80 Un Range: 0.1-1.0Un	2.4 s Range: 0-600000ms
U<<	Default: 0.30 Un Range: 0.1-1.0Un	800 ms Range: 0-600000ms
f>>	Default: 52.5 Hz Range: 50.11-55.0Hz	≤ 100 ms Range: 0-600000ms
f>	Default: 51.5 Hz Range: 50.11-55.0Hz	≤ 5 s Range: 0-600000ms
f<	Default: 47.5 Hz Range: 45.0-49.88Hz	Default: 100 ms Range: 0-600000ms

Table 2 STP 110-60 default protection setting for VDE-AR-N4120:2018

Function	Protection value	Trip time
Step for Voltage protection	0.1V	0.01s
Step for Frequency protection	0.01Hz	0.01s

Table 3 STP 110-60 setting step for voltage/frequency protection

The protection functions is independence from other set point, once the set points is fixed, it' s cannot be possible to change the protection set point by remote power plant controller.

After the inverter trip for protection, when the voltage recovers to at least 95%Un and frequency is between 49.9~50.1Hz, STP 110-60 has the setting of the delay time of recovery for both VDE-AR-N 4110 and 4120, the setting range is from 0 to 30 mins, default setting is 10 mins. And for VDE-AR-N 4120 only, inverter will wait PPC(power plant controller)' s release signal for reconnection first when PPC detect the PV plant grid connection point voltage is over 95%Un.

Notes: STP 110-60 didn' t provide testing terminal for protection test without disconnect the wires, such test terminal would be supplied at the system level on the LV side of MV transformer.

b) Intrinsic ("self") protection

For both VDE-AR-N 4110 and 4120, STP 110-60 is integrated with intrinsic hardware protection only for over voltage, the protection is for hardware protection and is not settable. The protection default setting is 1.4Un for 1ms

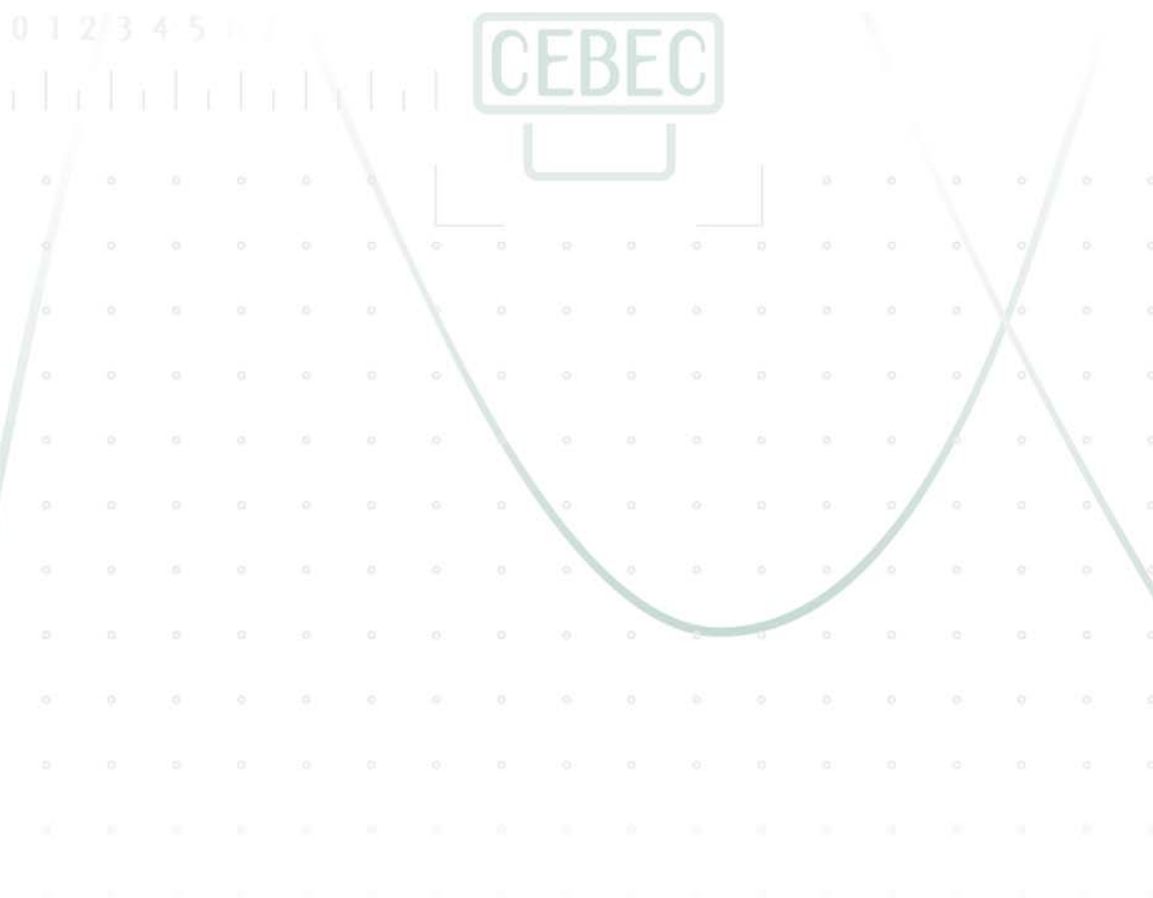

6. Active power control

a) Frequency control (P(f)-diagram)

For both VDE-AR-N 4110 and 4120, P(f)-diagram is default according to Figure 6 below.

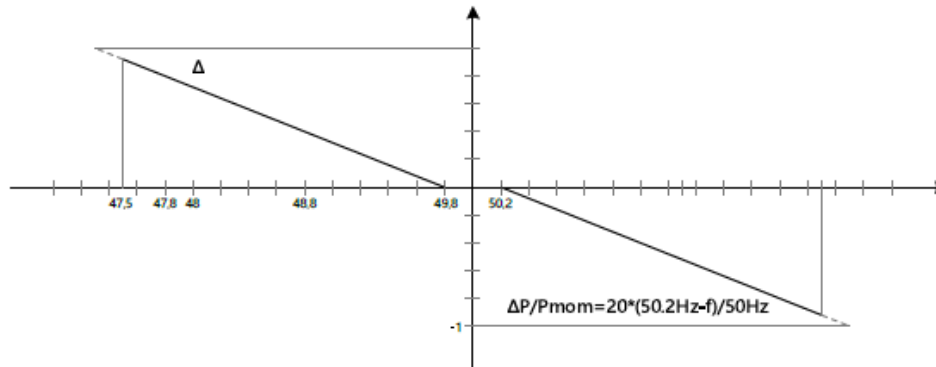

Figure 6 STP 110-60 P(f)-diagram

Note: Here Pmom is the active power freeze at that moment when the frequency to 50.2Hz. Pn is normal active power. The default gradient for over-frequency and under-frequency is 40%Pref/Hz (slope=5%), while it can be adjustable from 16.67%Pref/Hz(s=12%) to 100%Pref/Hz(s=2%).

When doing for TR3 test, due to the requirement by FGW TR3, inverter take higher priority for active power rising during frequency drop from 49.8Hz to 47.5Hz temporary than dispatching command by grid operator set point only for test purpose, but the final inverter will take higher priority for dispatching command set point.

b) Related gradients, dynamics and functions

For both VDE-AR-N 4110 and 4120, the following active power control applied to STP 110-60.

Normal active power gradients: 0.33%Pn/s~0.66%Pn/s (default is 0.66%Pn/s) for stationary connection and reconnection after grid fault trip.

P(f)-diagram: When frequency over 50.2Hz and dropping below 49.8Hz, the active power gradients is 100%Pn/s. When frequency returned to rated value (50Hz±0.2Hz), for the first 10mins, the active power gradients is less than 10%Pn/min, after 10mins quit from abnormal frequency, the active power gradients will back to normal active power gradients: 0.33%Pn/s~0.66%Pn/s.

Dynamic functions: When STP 110-60 enter into FTR, the active power reduced to zero to ensure reactive power, after the FTR end according to Figure 4 limit or 5s whichever is the earlier, the active power will recover by max ramp rate within 1s.

c) Set point

For both VDE-AR-N 4110 and 4120, the active power control set point applied to STP 110-60 is according to Table 4.

Function	Default Set point	Set range
Frequency-power response	ON	ON/OFF
FA (0.01Hz step)	47.5Hz	45-49.8Hz
PA (1%Pn step)	92% (refer to Pn)	0-100%
FB	49.8Hz	45-49.8Hz
PB	0% (refer to Pn)	0-100%
FC	50.2Hz	50.2-55Hz
PC	100% (refer to Pmom)	0-100%
FD	52.5Hz	50.2-55Hz
PD	8% (refer to Pmom)	0-100%
FE	52.5Hz	50.2-55Hz
PE	0% (refer to Pmom)	0-100%
Power rate limit	ON	ON/OFF
Power rise	39.6%/min	19.8%-39.6%/min
Power decline	39.6%/min	19.8%-39.6%/min

Table 4 Active power set point for STP 110-60

7. Reactive power control

a) Related gradients, dynamics and functions

For both VDE-AR-N 4110 and 4120, STP 110-60 reactive power control is following according to Figure 7 below.

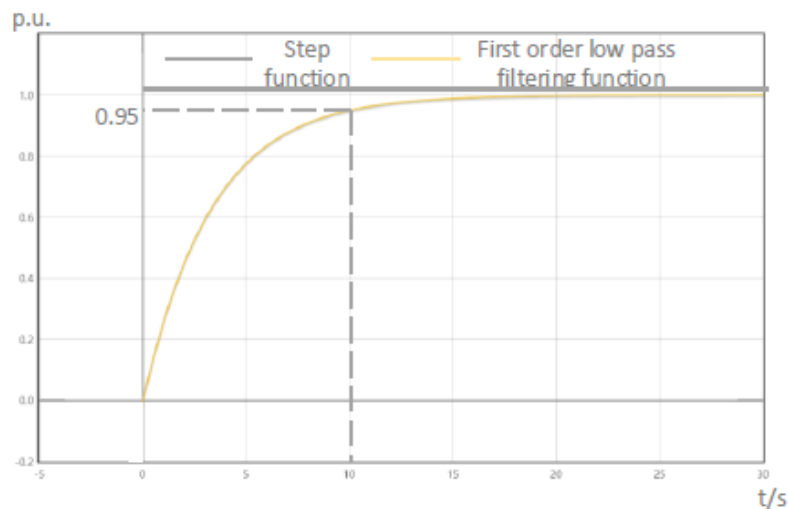

Figure 7 STP 110-60 reactive power control feature

The reactive power is supplied by equation (1):

$$Q = Q_{set} * [1 - e^{-(t/3\tau)}] \quad (1)$$

Here the time constant 3τ is settable as the time for 95% target value.

For VDE-AR-N 4110, the 3τ setting range is from 1~60s, the default setting is 10s.

For VDE-AR-N 4120, the 3τ setting range is from 1~60s, the default setting is 5s.

As VDE-AR-N 4120 requires for 90% target value time while VDE-AR-N 4110 requires for 95% target value time, so the time constant setting for VDE 4120 from 1~5s will multiplied 1.3times internal PV inverter processing to make sure 90% target value time by the equation is same as the setting time.

b) Set point

For VDE-AR-N 4110 and 4120, the reactive power control set point applied to STP 110-60 is according to Table 5.

Function	Default Set point	Set range
Q-Var switch	OFF	Pf/Qt/Off/QP/QU ⁽¹⁾
Pf (when select Pf) (0.001)	1.000	-0.8~+0.8
Q-Var limit(when select Qt) (0.1%)	100.0%	0~100% (refer to Qmax)
Upper power (when select Q(P)	90%	10%~100%
Upper Q (when select Q(P)	33%	+33%~-33%
Middle power (when select Q(P)	60.0%	10%~100%
Middle Q (when select Q(P)	5%	+33%~-33%
Lower power (when select Q(P)	50%	10%~100%
Lower Q (when select Q(P)	0	+33%~-33%
QP Curve	B	A/B (curve A set for PF)
Lower U limit (when select QU curve A)	96.0% for VDE 4110 95.0% for VDE 4120	80%~100%
Upper U limit(when select QU curve A)	104.0% for VDE 4110 105.0% for VDE 4120	100%~120%
U1 limit(when select QU curve A)	100.0%	90%~110%
U2 limit(when select QU curve A)	100.0%	90%~110%
Hysteresis(when select QU curve A)	0.0%	0%~5%
Lower Q(when select QU curve A)	-33.0%	-48%~+41%
Upper Q(when select QU curve A)	+33.0%	-48%~+41%
Q_U1 limit(when select QU curve A)	0.0%	-48%~+41%
Q_U2 limit(when select QU curve A)	0.0%	-48%~+41%
QU Curve	A	A/B
Lower U limit (when select QU curve B)	94.0%	80%~100%
Upper U limit(when select QU curve B)	106.0% for VDE 4120	100%~120%
U1 limit(when select QU curve B)	96.0%	90%~110%
U2 limit(when select QU curve B)	104.0%	90%~110%
Hysteresis(when select QU curve	0.0%	0%~5%

B)		
Lower Q(when select QU curve B)	-33.0%	-48%~+41%
Upper Q(when select QU curve B)	+33.0%	-48%~+41%
Q_U1 limit(when select QU curve B)	0.0%	-48%~+41%
Q_U2 limit(when select QU curve B)	0.0%	-48%~+41%
Q-Var control	ON	ON/OFF
Q time constant	10s for VDE 4110 5s for VDE 4120	1~60s 1~60s

Table 5 Reactive power set point for STP 110-60

(1) Pf The reactive power can be regulated by the parameter PF (Power Factor).

Qt The reactive power can be regulated by the parameter Q-Var limits (in %).

Off The PF is limited to +1.000, and the "Q-Var limits" is limited to 0.0%.

Q(P) The PF changes with the output power of the inverter.

Q(U) The reactive power changes with the grid voltage.

8. Dynamic reactive current control

a) Basic functions

The reactive current supply during FRT is calculated by both positive sequence and negative sequence component. The additional reactive current Δi_B of STP 110-60 is proportional to the voltage deviation Δu ($\Delta i_B = k \cdot \Delta u$), where k is the amplification factor. It is defined by the straight line below in Figure 8.

The k factor is settable between 0 to 10 with the step of 0.1, the default STP 110-60 k factor for VDE-AR-N 4110 is 2, and for VDE-AR-N 4120 is 5.

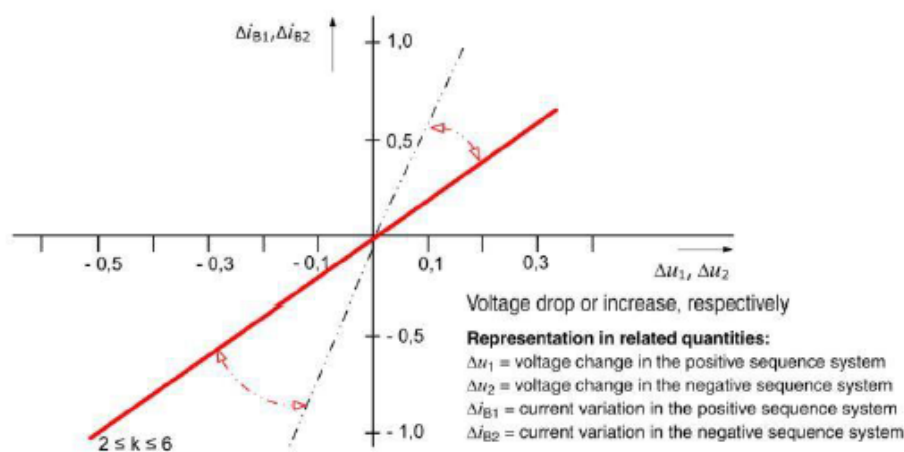

Figure 8 k factor of voltage support in the event of a network fault