

## 3-Phase Hybrid Inverter

### User Manual

## SH5.0RT / SH6.0RT / SH8.0RT / SH10RT





# All Rights Reserved

## All Rights Reserved

No part of this document can be reproduced in any form or by any means without the prior written permission of Sungrow Power Supply Co., Ltd (hereinafter "SUNGROW").

## Trademarks

**SUNGROW** and other Sungrow trademarks used in this manual are owned by SUNGROW.

All other trademarks or registered trademarks mentioned in this manual are owned by their respective owners.

## Software Licenses

- It is prohibited to use data contained in firmware or software developed by SUNGROW, in part or in full, for commercial purposes by any means.
- It is prohibited to perform reverse engineering, cracking, or any other operations that compromise the original program design of the software developed by SUNGROW.

# About This Manual

The manual mainly contains the product information, as well as guidelines for installation, operation and maintenance. The manual does not include complete information about the photovoltaic (PV) system. The reader can get additional information about other devices at [www.sungrowpower.com](http://www.sungrowpower.com) or on the webpage of the respective component manufacturer.

## Validity

This manual is valid for the following inverter models:

- SH5.0RT
- SH6.0RT
- SH8.0RT
- SH10RT

They will be referred to as "inverter" hereinafter unless otherwise specified.

## Target Group

This manual is intended for inverter owners who will have the ability to interact with the inverter and qualified personnel who are responsible for the installation and commissioning of the inverter. Qualified personnel should have the following skills:

- Training for installation and commissioning of electrical system, as well as dealing with hazards
- Knowledge of the manual and other related documents
- Knowledge of the local regulations and directives

## How to Use This Manual

Read the manual and other related documents before performing any work on the inverter. Documents must be stored carefully and be available at all times.

Contents may be periodically updated or revised due to the product development. The manual content of subsequent versions of the inverter may be subject to change. The latest manual can be found at [support.sungrowpower.com](http://support.sungrowpower.com).

## Symbols

Important instructions contained in this manual should be followed during installation, operation and maintenance of the inverter. They will be highlighted by the following symbols.

### DANGER

Indicates a hazard with a high level of risk that, if not avoided, will result in death or serious injury.



 **WARNING**

Indicates a hazard with a medium level of risk that, if not avoided, could result in death or serious injury.

 **CAUTION**

Indicates a hazard with a low level of risk that, if not avoided, could result in minor or moderate injury.

**NOTICE**

Indicates a situation that, if not avoided, could result in equipment or property damage.



Indicates additional information, emphasized contents or tips that may be helpful, e.g. to help you solve problems or save time.



# Contents

---

All Rights Reserved .....	I
About This Manual .....	II
<b>1 Safety</b> .....	1
1.1 PV Panels.....	1
1.2 Utility Grid .....	1
1.3 Inverter .....	2
1.4 Batteries .....	3
<b>2 Product Description</b> .....	4
2.1 System Introduction .....	4
2.2 Product Introduction.....	4
2.3 Symbols on the Product .....	6
2.4 LED Indicator .....	7
2.5 DC Switch .....	7
2.6 PV Energy Storage System (PV ESS).....	8
2.6.1 PV ESS Introduction.....	8
2.6.2 Declaration For Back-Up Function .....	9
2.6.3 Energy Management.....	9
2.7 Parallel System .....	11
2.8 Retrofitting the Existing PV System .....	13
<b>3 Function Description</b> .....	15
3.1 Safety Function.....	15
3.1.1 Protection.....	15
3.1.2 Earth Fault Alarm.....	15
3.2 Energy Conversion and Management.....	15
3.2.1 Power Derating.....	15
3.2.2 DRM ( “ AU ” / “ NZ ” ).....	16
3.2.3 Regular Operational Voltage Range .....	16
3.2.4 Regular Operational Frequency Range.....	17
3.2.5 Reactive Power Regulation .....	17
3.2.6 Load Control.....	17
3.3 Battery Management.....	17

3.3.1 Charge Management.....	19
3.3.2 Discharge Management .....	20
3.4 Communication and Configuration .....	21
<b>4 Unpacking and Storage .....</b>	<b>22</b>
4.1 Unpacking and Inspection.....	22
4.2 Scope of Delivery .....	23
4.3 Inverter Storage .....	24
<b>5 Mechanical Mounting .....</b>	<b>25</b>
5.1 Safety during Mounting .....	25
5.2 Location Requirements .....	25
5.2.1 Environment Requirements.....	25
5.2.2 Carrier Requirements.....	26
5.2.3 Angle Requirements .....	26
5.2.4 Clearance Requirements .....	26
5.3 Installation Tools.....	27
5.4 Moving the Inverter .....	28
5.5 Installing the Inverter .....	29
<b>6 Electrical Connection .....</b>	<b>31</b>
6.1 Safety Instructions.....	31
6.2 Terminal Description.....	31
6.3 Electrical Connection Overview .....	33
6.4 Additional Grounding Connection .....	37
6.4.1 Additional Grounding Requirements.....	37
6.4.2 Connection Procedure .....	37
6.5 AC Cable Connection .....	38
6.5.1 AC Side Requirements .....	38
6.5.2 Assembling the AC Connector .....	39
6.5.3 Installing the AC Connector.....	41
6.6 DC Cable Connection .....	43
6.6.1 PV Input Configuration .....	44
6.6.2 Assembling the PV Connectors .....	45
6.6.3 Installing the PV Connector .....	46
6.7 Communication Connection .....	48
6.7.1 Ethernet Connection.....	48
6.7.2 WiNet-S Connection.....	50
6.7.3 RS485 Connection .....	53

6.8 Smart Energy Meter Connection.....	56
6.9 Battery Connection.....	57
6.9.1 Connecting the Power Cable.....	57
6.9.2 Connecting the CAN Cable .....	59
6.9.3 Connecting the Enable Cable.....	59
6.10 DO Connection.....	60
6.11 DI Connection .....	61
6.11.1 Assembling the COM Connector.....	62
6.11.2 Installing the COM Connector .....	64
6.12 Backup Connection.....	65
<b>7 Commissioning .....</b>	<b>67</b>
7.1 Inspection before Commissioning.....	67
7.2 Commissioning Procedure .....	67
7.3 App Preparation .....	68
7.4 Creating a Plant.....	68
7.5 Initializing the Device .....	71
7.6 Configuring the Plant.....	72
<b>8 iSolarCloud App .....</b>	<b>77</b>
8.1 Brief Introduction.....	77
8.2 Installing the App.....	77
8.3 Account Registration .....	78
8.4 Login .....	79
8.4.1 Requirements.....	79
8.4.2 Login Procedure.....	79
8.5 Initial Settings.....	81
8.5.1 Feed-in Limitation.....	81
8.5.2 Off-grid Mode .....	81
8.5.3 Reactive Power Regulation Mode .....	81
8.6 Function Overview .....	84
8.7 Home.....	85
8.8 Run Information .....	86
8.9 Records .....	86
8.9.1 Chart.....	87
8.9.2 Fault Alarm Record.....	88
8.10 More.....	88
8.10.1 System Parameters .....	89

8.10.2 Running Time .....	90
8.10.3 Regular Parameters.....	90
8.10.4 Off-grid Parameters.....	91
8.10.5 Active Power Regulation .....	91
8.10.6 Reactive Power Regulation .....	92
8.10.7 Battery Discharge Time.....	92
8.10.8 Battery Forced Charge Time .....	93
8.10.9 Load Control.....	93
8.10.10 Communication Parameters .....	95
8.10.11 Firmware Update.....	96
8.10.12 Grounding Detection .....	97
8.10.13 Parallel Configuration.....	97
8.10.14 Frequency Shift Power Control .....	98
<b>9 System Decommissioning .....</b>	<b>99</b>
9.1 Decommissioning the Inverter .....	99
9.1.1 Disconnecting the Inverter .....	99
9.1.2 Dismantling the Inverter .....	100
9.1.3 Disposal of the Inverter .....	100
9.2 Decommissioning the Battery .....	101
<b>10 Troubleshooting and Maintenance .....</b>	<b>102</b>
10.1 Troubleshooting .....	102
10.2 Maintenance .....	108
10.2.1 Maintenance Notices.....	108
10.2.2 Routine Maintenance.....	109
10.2.3 Replacing the Button Cell.....	109
<b>11 Appendix .....</b>	<b>110</b>
11.1 Technical Data .....	110
11.2 The Compatibility for Backup under Off-grid Scenario.....	115
11.3 Quality Assurance .....	116
11.4 Contact Information .....	116

# 1 Safety

The device has been designed and tested strictly according to international safety regulations. Read all safety instructions carefully prior to any work and observe them at all times when working on or with the device.

Incorrect operation or work may cause:

- Injury or death to the operator or a third party;
- Damage to the device and other properties.

All detailed work-related safety warnings and notes are specified at critical points in this manual.



The safety instructions in this manual cannot cover all the precautions that should be followed. Perform operations considering actual onsite conditions. SUNGROW shall not be held liable for any damage caused by violation of the safety instructions in this manual.

## 1.1 PV Panels

### DANGER

PV strings will produce electrical power when exposed to sunlight and can cause a lethal voltage and an electric shock.

- Always keep in mind that the inverter is dual power supplied. Electrical operators must wear proper personal protective equipment: helmet, insulated footwear, gloves, etc.
- Before touching the DC cables, operator must use a measuring device to ensure that the cable is voltage-free.
- The operator must follow all warnings on the PV strings and in its manual.

## 1.2 Utility Grid

Follow the regulations related to the utility grid.

**NOTICE**

All electrical connections must be in accordance with local and national standards.

Only with the permission of the local utility grid company, the inverter can be connected to the utility grid.

### 1.3 Inverter

**⚠ DANGER**

Danger to life from electric shocks due to live voltage

Do not open the enclosure at any time. Unauthorized opening will void warranty and warranty claims and in most cases terminate the operating license.

**⚠ WARNING**

Risk of inverter damage or personal injury

- Do not connect or disconnect the PV, battery and AC connectors when the inverter is running.
- Wait at least 10 minutes for the internal capacitors to discharge after all electric devices are removed and the inverter is powered off.
- Ensure that there is no voltage or current before connecting or disconnecting the PV, battery and AC connectors.

**⚠ WARNING**

All safety instructions, warning labels, and nameplate on the inverter:

- Must be clearly legible.
- Should not be removed or covered.

**⚠ CAUTION**

Risk of burns due to hot components!

Do not touch any hot parts (such as the heat sink) during operation. Only the DC switch can safely be touched at any time.



**NOTICE**

Only qualified personnel can perform the country setting. Unauthorized alteration may cause a breach of the type-certificate marking.

Risk of inverter damage due to electrostatic discharge (ESD)!

By touching the electronic components, you may damage the inverter. For inverter handling, be sure to:

- avoid any unnecessary touching;
- wear a grounding wristband before touching any connectors.

## 1.4 Batteries

** DANGER**

Batteries deliver electric power, resulting in burns or a fire hazard when they are short circuited, or wrongly installed.

Lethal voltages are present at the battery terminals and cables connecting to the inverter. Severe injuries or death may occur if the cables and terminals in the inverter are touched.

**NOTICE**

Improper settings or maintenance can permanently damage the battery. Incorrect inverter parameters will lead to the premature aging of battery.

## 2 Product Description

### 2.1 System Introduction

#### **⚠ WARNING**

- The inverter must only be operated with PV strings with class II protection in accordance with IEC 61730, application class A. It is not allowed for the positive pole or the negative pole of the PV strings to be grounded. This can cause the inverter to be destroyed.
- Damages to the product due to a faulty or damaged PV installation are not covered by warranty.
- Any use other than the one described in this document is not permitted.

#### **NOTICE**

For the TT utility grid, the N line voltage to ground must be 30 V or less.

The three-phase hybrid inverters are applicable to both on-grid and off-grid PV systems. With the integrated Energy Management System (EMS), they can control and optimize the energy flow so as to increase the self-consumption of the system.

### 2.2 Product Introduction

#### **Model Description**

The model description is as follows (take SH10RT as an example):

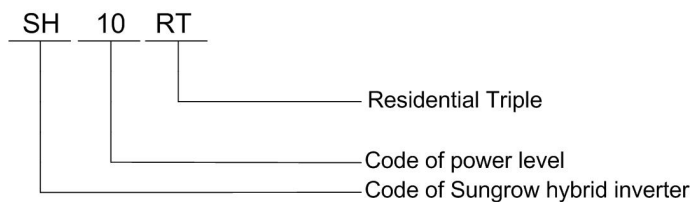

#### **Appearance**

The image shown here is for reference only. The actual product received may differ.

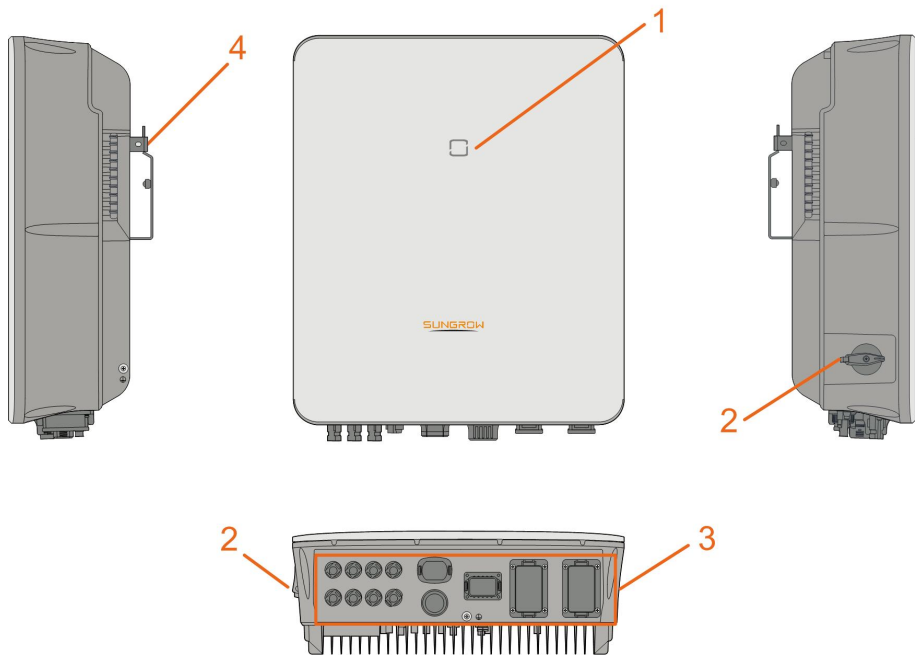

figure 2-1 Inverter Appearance

No.	Name	Description
1	LED indicator panel	Indicates the current working state of the inverter.
2	DC switch	Used to safely disconnect the DC circuit.
3	Electrical connection area	Includes DC terminals, AC terminals, battery terminals, communication terminals and additional grounding terminal.
4	Hanger	Used to hang the inverter on the wall-mounting bracket.

### Dimensions

The following figure shows the dimensions of the inverter.

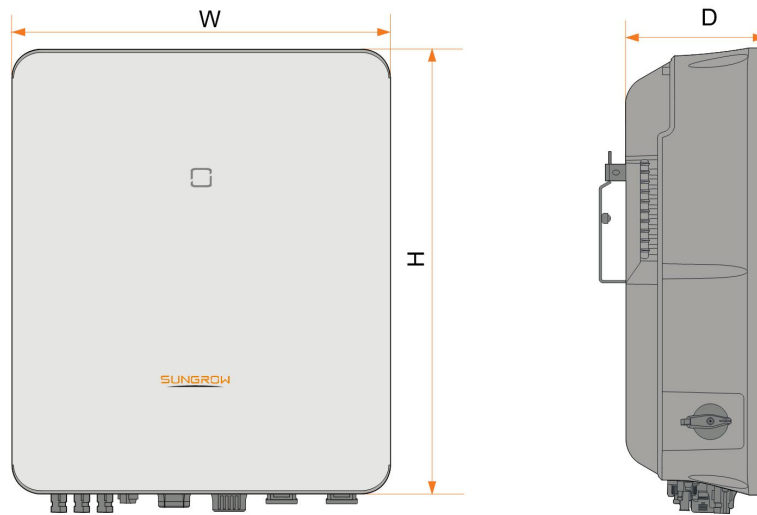













figure 2-2 Dimensions of the Inverter

W (mm)	H (mm)	D (mm)	Weight (kg)
460	540	170	27

## 2.3 Symbols on the Product



Symbol	Explanation
	RCM mark of conformity.
	TÜV mark of conformity.
	CE mark of conformity.
	Do not dispose of the inverter together with household waste.
	The inverter does not have a transformer.
	Disconnect the inverter from all the external power sources before maintenance!
	Read the user manual before maintenance!
	Burn danger due to hot surface that may exceed 60°C.

Symbol	Explanation
	Danger to life due to high voltages! Only qualified personnel can open and service the inverter.
	Do not touch live parts for 10 minutes after disconnection from the power sources.
	Additional grounding point.

## 2.4 LED Indicator

The LED indicator on the front of the inverter indicates the working state of the inverter.

table 2-1 LED indicator description

LED indicator	LED state	Definition
 Blue	ON	The inverter is running in the on/off-grid mode.
	Twinkling	The inverter is at standby or startup state (without on/off-grid operation).
 Red	ON	A system fault has occurred.
 Gray	OFF	Both the AC and DC sides are powered down.

## 2.5 DC Switch

The DC switch is used to safely disconnect the DC circuit whenever necessary.

The inverter operates automatically when input and output requirements are met. Rotate the DC switch to the “OFF” position to stop the inverter when a fault occurs or when you need to stop the inverter.



Turn the DC switch to the “ON” position before restarting the inverter.

## 2.6 PV Energy Storage System (PV ESS)

### 2.6.1 PV ESS Introduction

By directly connecting a battery module to the inverter, the conventional PV system can be upgraded to be an Energy Storage System (ESS).

The system is capable of operating off-grid to ensure an emergency power supply for protected loads in the event of a grid interruption or blackout, which may be caused by:

- islanding;
- under-voltage;
- under-frequency or over-frequency.

#### NOTICE

- Under any connection, either grid-connection or off-grid application, please be sure that the potential voltage between N and PE line is not higher than 30V, otherwise, inverter will stop generating power.
- The system is not suitable for supplying life-sustaining medical devices. It cannot guarantee backup power in all circumstances.

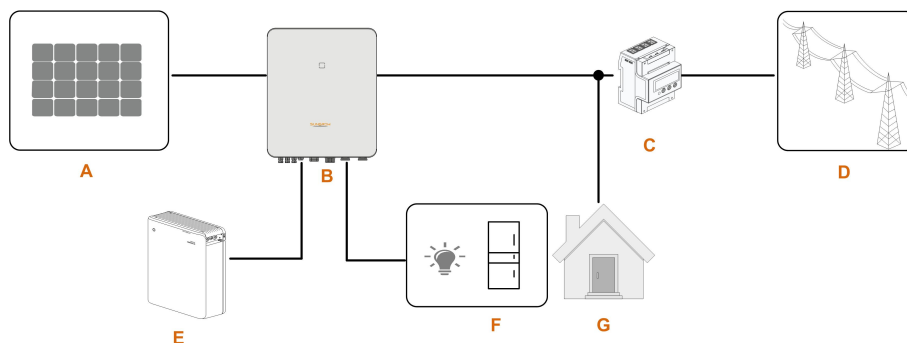

figure 2-3 PV Energy Storage System (PV ESS)

table 2-2 System Compositions

Item	Description	Remark
A	PV strings	Compatible with monocrystalline silicon, polycrystalline silicon, and thin-film without grounding.
B	Inverter	SH5.0RT / SH6.0RT / SH8.0RT / SH10RT
C	Three-phase Smart Energy Meter	Measures the export power and communicates with the inverter via the RS485 port.
D	Utility grid	Grid grounding system types: TT, TN
E	Battery (optional)	A Li-ion battery

Item	Description	Remark
F	Backup loads	Protected house loads directly connected to the inverter.
G	Normal Loads	Non protected house loads, they will disconnect in case of grid failure.

## 2.6.2 Declaration For Back-Up Function

The following statement involves SUNGROW general policies about the hybrid inverters described in this document.

- 1 For hybrid inverters, the electrical installation typically includes connection of the inverter to both PV modules and batteries. If there is no available power from batteries or PV modules in backup mode, the backup power supply will be automatically terminated. SUNGROW shall hold no liability for any consequences arising from failing to observe this instruction.
- 2 Normally, the Back-Up switching time is less than 20 ms. However, some external factors may cause the system to fail on Back-Up mode. Therefore, the users must be aware of conditions and follow the instructions as below:
  - Do not connect loads that are dependent on a stable energy supply for a reliable operation.
  - Do not connect the loads whose total capacity is greater than the maximum Back-Up capacity.
  - Do not connect the loads that may cause very high start-up current surges, such as non-frequency conversion air conditioning, vacuum cleaner or half-wave loads such as hair dryer, heat gun, hammer drill. Refer to "[11.2 The Compatibility for Backup under Off-grid Scenario](#)" for recommended loads.
  - Due to the condition of the battery itself, battery current might be limited by some factors, including but not limited to the temperature and weather.

### Declaration For Back-Up Overload Protection

The inverter will restart in case of overload protection. The time required for restarting will increase (5 min at most) if overload protection repeats. Try to reduce Back-Up load power within maximum limitation or remove the loads which may cause very high start-up current surges.

## 2.6.3 Energy Management

The battery discharges to provide energy to loads. If the battery is empty or there is not enough power from the battery system, the grid shall supply the power, first to Backup loads, then normal loads.

When the grid is present, the bypass function of the hybrid inverter is activated and the Backup loads will be directly connected to the grid via the bypass switch integrated in the inverter.

If the Smart Energy Meter is abnormal or not equipped, the inverter will run normally, however, the battery can be charged but not allowed to discharge. In this case the feed-in power setting will be ineffective, and the DO function for optimized mode will be disabled.

### Energy Management during Daytime

The energy management system (EMS) works in self-consumption mode by default.

- Scenario 1: PV power generation  $\geq$  Load power consumption
  - First, PV power will go to Backup loads first, then normal loads and the battery.
  - Moreover, If the battery is fully charged, the excess will go to the grid. The feed-in power will not surpass the feed-in limitation value in initial settings.
- Scenario 2: PV power generation < Load power consumption
  - First, battery will discharge and provide the energy missing.
  - Moreover, inverter will draw power from the mains if the power from the PV and battery is less than the load power.

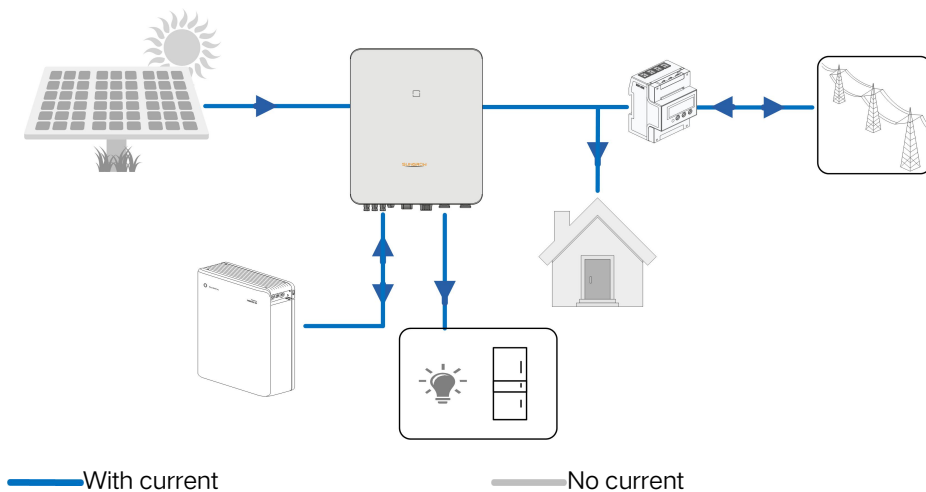

### Energy Management during Night

During night, with energy available, the battery will discharge to supply power for loads. Alternatively, the grid will supply power for the loads in case the discharge power of the battery is insufficient.



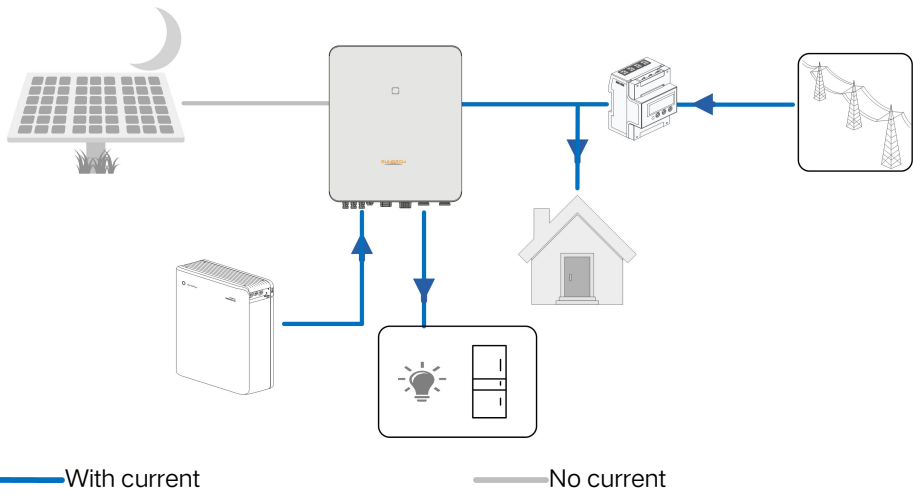

During night, when the battery is empty, it will enter into standby mode. In this case, the grid will supply all power for loads.

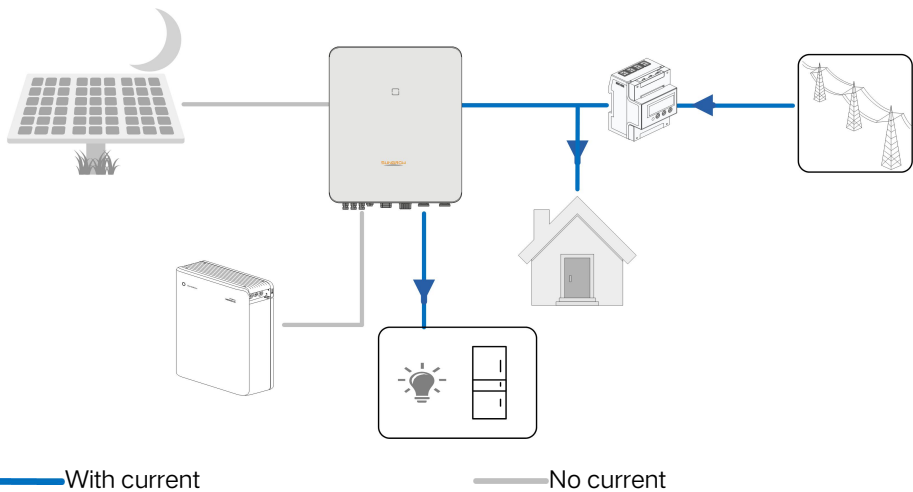

## 2.7 Parallel System

Maximum five hybrid inverters with the same type can be connected in parallel in the PV ESS via RS485 communication. The parallel system can operate in both on-grid and off-grid modes.

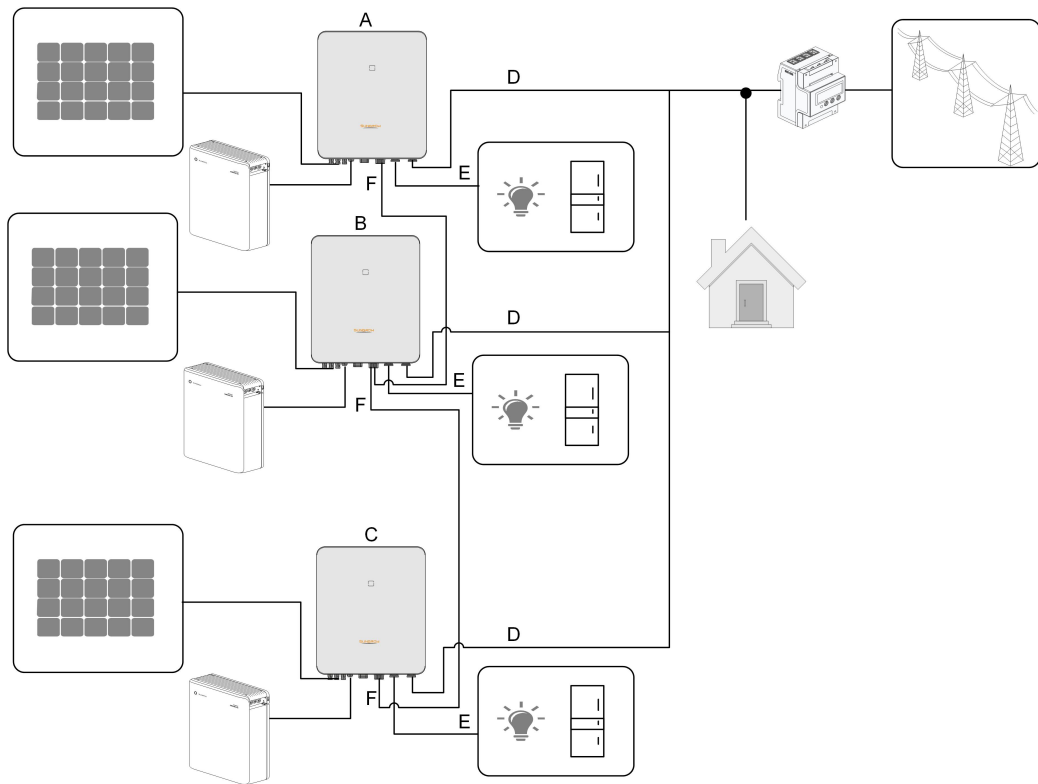

**figure 2-4** Parallel PV ESS

(A) Master

(B) Slave 1

(C) Slave 2

(D) GRID

(E) BACK-UP

(F) RS485



Only the inverter GRID terminal can be connected in parallel, the BACK-UP terminal and the battery terminal cannot be connected together, they should be connected to the off-grid load and the battery respectively. The Backup loads of each inverter should not exceed its nominal power.

Refer to "[6.7.3 RS485 Connection](#)" for the cable connection.

In an on-grid parallel system, the master inverter collects information from Smart Energy Meter and slave inverter and performs the energy management including:

- Feed-in power control.
- Battery charge / discharge
- Maximum power limitation

The following settings are required for the inverter parallel function.

- Feed-in power control. The feed-in power control function refers to "[8.5.1 Feed-in Limitation](#)". The PV installation power of the master inverter is the total installation power of the system, the slave inverters do not need to set the feed-in power.
- Ripple Control. The Ripple Control device only needs to be connected to the master inverter, which will perform unified scheduling. Refer to "[6.11 DI Connection](#)" for the cable connection. Refer to "[8.10.5 Active Power Regulation](#)" to enable it in the iSolar-Cloud App.
- Parallel Configuration. Refer to "[8.10.13 Parallel Configuration](#)" to configure the master and slave inverters in the iSolarCloud App.

## 2.8 Retrofitting the Existing PV System

The hybrid inverter is compatible with any three-phase PV grid-connected inverters. An existing PV system can be retrofitted to be a PV ESS with the addition of the hybrid inverter.

The power generation from the existing PV inverter will be firstly provided to the loads and then charge the battery. With the energy management function of the hybrid inverter, the self-consumption of the new system will be greatly improved.

### On-grid Port to Retrofit the Existing PV System

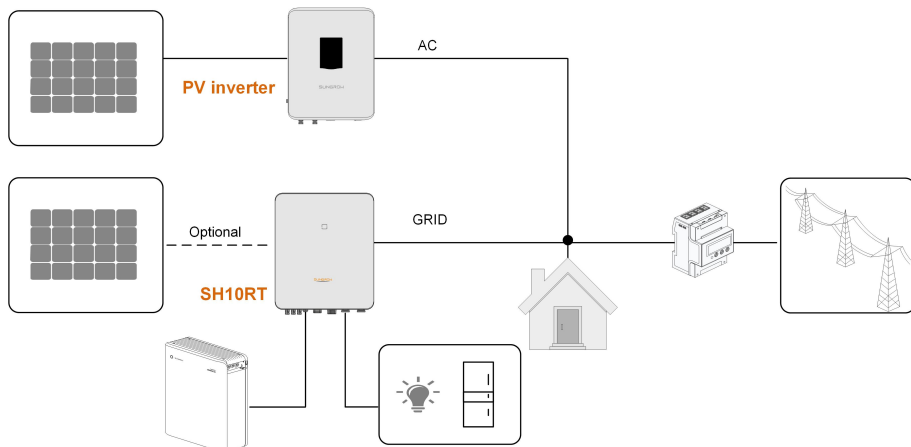

figure 2-5 On-grid Port to Retrofit the Existing PV System

The AC terminal of the PV inverter and the GRID terminal of the hybrid inverter are connected in parallel.

### Off-grid Port to Retrofit the Existing PV System

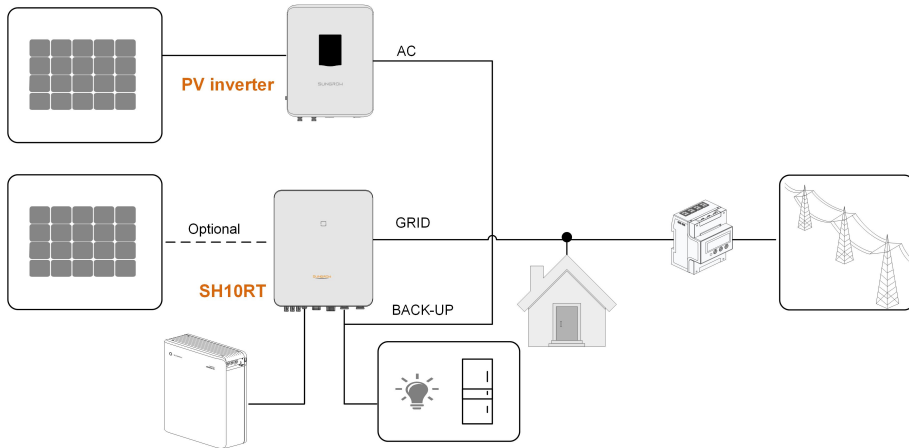

figure 2-6 Off-grid Port to Retrofit the Existing PV System

The off-grid port retrofits the existing PV system in order to maximize the use of PV energy by allowing the PV inverter to work even when off-grid.

The AC terminal of the PV inverter and the BACK-UP terminal of the hybrid inverter are connected in parallel.

The PV inverter power cannot exceed the nominal power of the hybrid inverter (if it is a single-phase PV inverter, the PV inverter power cannot exceed the single-phase nominal power of the three-phase hybrid inverter).

Before retrofitting the existing PV system to an off-grid port, the "Frequency Shift Power Control" parameter needs to be enabled. For details, please refer to "[8.10.14 Frequency Shift Power Control](#)".

Note:

- 1 In zero-export scenario, the hybrid inverter can only ensure no power exported to grid itself but does not ensure zero export for the PV inverter. Please contact the PV inverter manufacturer for its zero-export solution.
- 2 PV modules for hybrid inverter are optional.

## 3 Function Description

### 3.1 Safety Function

#### 3.1.1 Protection

Several protective functions are integrated in the inverter, including short circuit protection, grounding insulation resistance surveillance, residual current protection, anti-islanding protection, DC overvoltage / over-current protection, etc.

#### 3.1.2 Earth Fault Alarm

The inverter has integrated a multiple-function dry-contact (DO relay), which can be used for the external alarm for earth fault. The external alarm needs to be powered by the grid.

The additional equipment required is a light indicator and/or a buzzer.

If an earth fault occurs:

- the DO dry-contact will switch on automatically to signal the earth fault alarm;
- the buzzer inside the inverter will also beep;
- the Ethernet communication port can be used for transmitting the alarm remotely.

### 3.2 Energy Conversion and Management

The inverter converts the DC power from the PV array or the battery to the AC power, in conformity with the grid requirements. It also transmits the DC power from the PV panel to the battery.

With the bidirectional converter integrated inside, the inverter can charge or discharge the battery.

Two string MPP trackers are used to maximize the power from PV strings with different orientations, tilts, or module structures.

#### 3.2.1 Power Derating

Power derating is a way to protect the inverter from overload or potential faults. In addition, the derating function can also be activated following the requirements of the utility grid. Situations requiring inverter power derating are:

- over-temperature (including ambient temperature and module temperature)
- high input voltage
- grid under-voltage
- grid over-frequency

- power factor (when values out of the rated values)
- high altitude

### 3.2.2 DRM ( “AU” / “NZ” )

The inverter provides a terminal block for connecting to a demand response enabling device (DRED). The DRED asserts demand response modes (DRMs). The inverter detects and initiates a response to all supported demand response commands within 2s. The following table lists the DRMs supported by the inverter.

table 3-1 Demand Response Modes (DRMs)

Mode	Explanation
DRM0	The inverter is in the state of “ Turn off ” .
DRM1	The import power from the grid is 0.
DRM2	The import power from the grid is no more than 50 % of the rated power.
DRM3	The import power from the grid is no more than 75 % of the rated power.
DRM4	The import power from the grid is 100 % of the rated power, but subject to the constraints from other active DRMs.
DRM5	The feed-in power to the grid is 0.
DRM6	The feed-in power to the grid is no more than 50 % of the rated power.
DRM7	The feed-in power to the grid is no more than 75 % of the rated power.
DRM8	The feed-in power to the grid is 100 % of the rated power, but subject to the constraints from other active DRMs.

The DRED may assert more than one DRM at a time. The following shows the priority order in response to multiple DRMs.

Multiple Modes	Priority Order
DRM1…DRM4	DRM1 > DRM2 > DRM3 > DRM4
DRM5…DRM8	DRM5 > DRM6 > DRM7 > DRM8

### 3.2.3 Regular Operational Voltage Range

The inverters can operate within the allowable voltage range for at least the specified observation time. The setting of the conditions depends on whether the connection is due to a normal operational start-up or an automatic reconnection after tripping of the interface protection.

When the voltage level is out of the operational levels, the inverter will disconnect from the grid within the protection time. If a disturbance lasts less than the required protection time, the inverter can reconnect to the grid once the voltage level goes back to normal levels after the disturbance.

### 3.2.4 Regular Operational Frequency Range

The inverter can operate within its frequency range for at least the specified observation time. The setting of conditions depends on whether the connection is due to a normal operational start-up or an automatic reconnection after tripping of the interface protection.

When the frequency level is outside the operational levels, the inverter will disconnect from the grid. If a disturbance lasts less than the required protection time, the inverter can reconnect to the grid once the frequency level goes back to normal levels after the disturbance.

### 3.2.5 Reactive Power Regulation

The inverter is capable of operating in reactive power regulation modes for the purpose of providing support to the grid. The reactive power regulation mode can be set via the iSolarCloud App.

### 3.2.6 Load Control

The inverter has an integrated multiple-function dry-contact (DO relay), which can be used for load control via a contactor.

User may set the control mode according to individual demand.

- **Timing Mode:** Set the starting time and end time. The DO function will be enabled during the time interval.
- **Switch Mode:** The DO function can be enabled or disabled.
- **Intelligent Mode:** Set the starting time, end time, and the optimized power. During the interval, when the export power reaches to the optimized power, the DO function will be enabled.

## 3.3 Battery Management

Li-ion battery from SUNGROW, LG Chem, BYD and Pylontech are compatible with the PV ESS, further battery models will be made compatible in the future.

The currently supported battery brands and models are shown in the following table.

Brand	Model	Firmware Version
SUN-GROW	SBR096/128/160/192/224/256	≥ SBRBCU-S_22011.01.05
LG Chem	RESU7H_Type_R RESU10H_Type_R	DC-DC converter version ≥ 4.8 Battery management system (BMS) version ≥ 1.7.0.1
BYD	Battery-Box HV 5.1, 6.4, 7.7, 9.0, 10.2, 11.5	≥ V3.013

Brand	Model	Firmware Version
	Battery-Box Premium HVS 5.1, 7.7, 10.2, 12.8	Battery management system (BMS) version $\geq$ 3.16
	Battery-Box Premium HVM 11.0, 13.8, 16.6, 19.3, 22.1	Battery management unit (BMU) version $\geq$ 3.7
Pylon-tech	Powercube-X1/X2/H1/H2	$\geq$ V4.6
	Force H1/H2	$\geq$ V1.3



The table is continually updated. If the battery model is not in the table, consult SUNGROW if it is supported.

To maximize the battery life, the inverter will perform battery charge, discharge, and battery maintenance based on the battery status communicated by the BMS.

#### NOTICE

The recommended parameters listed in this section may be updated or revised due to product development. Please refer to the manual supplied by the battery manufacturer for the latest information.

#### State Definition

In order to avoid overcharging or deep discharging of the battery, three battery statuses according to different voltage ranges has been defined, as shown in the following table.

table 3-2 Battery Status Definition

Type	Port Voltage / SOC		
	Empty	Normal	Full
SUNGROW (SBR096/128/ 160/192/224/256)	SOC < 5 %	5 %...100 % (by default)	SOC = 100 %
LG Chem(RE- SU7H_Type_R) LG Chem(RE- SU10H_Type_R)	SOC < 8 %	8 %...100 % (by default)	SOC = 100 %
BYD (Battery-Box HV)	SOC < 10 %	10 %...100 % (by default)	SOC = 100 %



Type	Port Voltage / SOC		
	Empty	Normal	Full
BYD (Battery-Box Premium HVM / HVS)	SOC < 5 %	5 %...100 % (by default)	SOC = 100 %
Pylontech (Powercube-X1/X2/H1/H2)	SOC < 8 %	8 %...100 % (by default)	SOC = 100 %
Pylontech (Force H1/H2)			

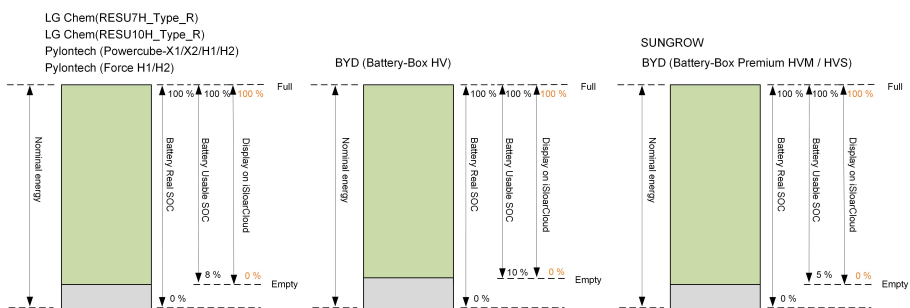

In the off-grid state, the LG Chem battery can only supply power to loads of maximum 5KW (such as RESU10H\_Type\_R). For the first operation of the inverter with LG Chem battery, either PV or grid needs to power the inverter to activate the LG Chem battery. The SOC limits of Li-ion batteries can be modified via the iSolarCloud App by qualified personnel.

### 3.3.1 Charge Management

#### Backup Charge Management

The emergency charge management function is to protect the battery from the damage caused by long time excessive discharge. The inverter cannot respond to discharge command during emergency charge. The following tables describe the emergency charge conditions for different types of batteries.

**table 3-3** Backup Charge Management for Li-ion Battery

Status	Conditions
Trigger	Either of the following conditions is met:
	<ul style="list-style-type: none"> <li>• <math>SOC \leq (\text{Min. SOC}) - 3\%</math> (valid only when the Min. SOC is <math>\geq 3\%</math>).</li> <li>• A battery under-voltage warning is triggered.</li> <li>• An emergency charge command is reported to the inverter.</li> </ul>
	All the following conditions are met:
Finish	<ul style="list-style-type: none"> <li>• <math>SOC \geq (\text{Min. SOC}) - 1\%</math> (valid only when the Min. SOC is <math>\geq 3\%</math>).</li> <li>• The battery under-voltage warning is cleared.</li> <li>• The emergency charge command reported to the inverter is cleared.</li> </ul>

**table 3-4** Default SOC Conditions for Li-ion Battery Backup Charge

Type	Trigger SOC	Finishing SOC
SUNGROW	$SOC \leq 2\%$	$SOC \geq 4\%$
LG Chem	$SOC \leq 5\%$	$SOC \geq 7\%$
BYD (Battery-Box HV)	$SOC \leq 7\%$	$SOC \geq 9\%$
BYD (Battery-Box Premium HVM / HVS)	$SOC \leq 2\%$	$SOC \geq 4\%$
Pylontech	$SOC \leq 5\%$	$SOC \geq 7\%$

### Normal Charge Management

When the battery voltage is within the normal range, the inverter can charge the battery if the PV power is higher than the load power and can ensure that the battery is never over-charged.

The maximum allowable charge current is limited to the smaller value among the following:

- the maximum charge current of the inverter (30A);
- the maximum / recommended charge current from the battery manufacturer.

For this reason, the battery charge power may not reach the nominal power.



- If the PV voltage is higher than the upper limit value of MPP voltage (1000 V), the battery cannot charge.
- The hybrid inverter will start to charge the battery when the export power value exceeds a pre-defined threshold value of 70 W.

### 3.3.2 Discharge Management

Discharge management can effectively protect the battery from deep discharging.

The maximum allowable discharge current is limited to the smaller value among the following:

- the maximum discharge current of the inverter (30A);
- the maximum / recommended discharge current from the battery manufacturer.

For this reason, the battery discharge power may not reach the nominal power.



- If the PV voltage is higher than the upper limit value of MPP voltage (1000 V), the battery cannot discharge.
- The hybrid system will start to discharge the battery when the import power value exceeds a threshold value of 70 W.

### 3.4 Communication and Configuration

The inverter provides various ports for device and system monitoring, including RS485, Ethernet, WLAN, and CAN; various parameters can be configured for optimal operation. All the inverter information is accessible through the iSolarCloud App.

## 4 Unpacking and Storage

### 4.1 Unpacking and Inspection

The device is thoroughly tested and strictly inspected before delivery. Nonetheless, damage may still occur during shipping. For this reason, please conduct a thorough inspection after receiving the device.

- Check the packing case for any visible damage.
- Check the scope of delivery for completeness according to the packing list.
- Check the inner contents for damage after unpacking.

Contact SUNGROW or the transport company in case of any damage or incompleteness, and provide photos to facilitate services.

Do not dispose of the original packing case. It is recommended to store the device in the original packing case when the device is decommissioned.

## 4.2 Scope of Delivery

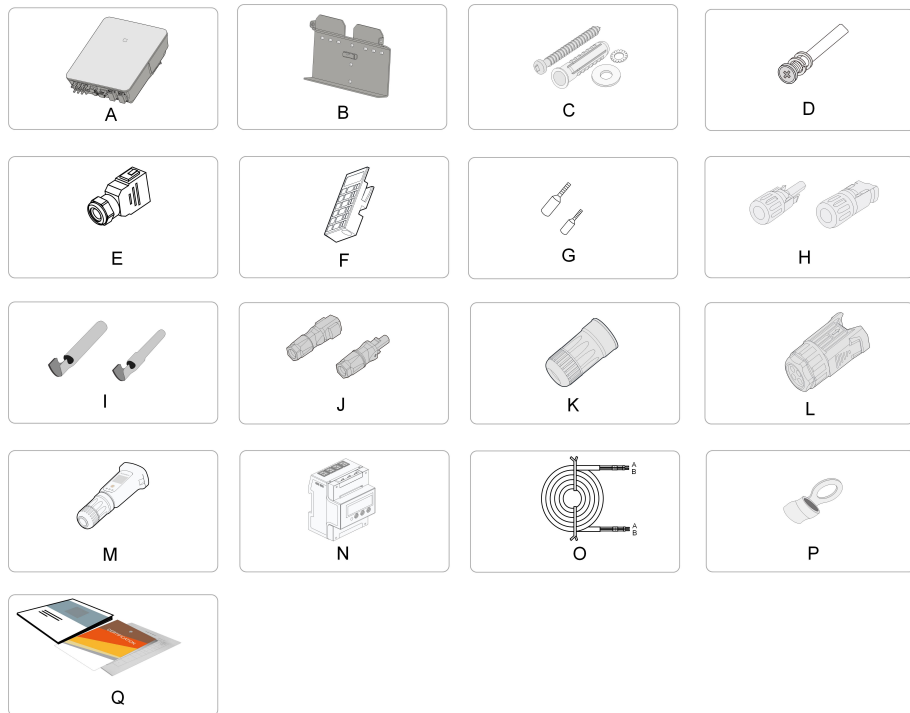

figure 4-1 Scope of delivery

Item	Name	Quantity
A	Inverter	1
B	Wall-mounting bracket	1
C	Expansion plug set	4
D	M4 screws and washers	2
E	AC/Backup connector set	2
F	Block (Optional)	1
G	Cord end terminal *	5
H	PV connectors	2 ~ 3
I	Crimp contact	2 ~ 3
J	SUNCLIX connector set	1
K	LAN connector set	1
L	COM connector set	1
M	WiNet-S module	1
N	Smart Energy Meter	1
O	RS485 cable	1
P	OT terminal	1
Q	Documents	1

\* There are cord end terminals of two specifications (5 for each specification) used to connect AC cables. Select appropriate terminals according to the cable cross-section area.

### 4.3 Inverter Storage

Proper storage is required if the inverter is not installed immediately.

- Store the inverter in the original packing case with the desiccant inside.
- The storage temperature must be always between  $-30^{\circ}\text{C}$  and  $+70^{\circ}\text{C}$ , and the storage relative humidity must be always between 0 and 95 %, non-condensing.
- In case of stacking storage, the number of stacking layers should never exceed the limit marked on the outer side of the packing case.
- The packing case should be upright.
- If the inverter has been stored more than half a year, the qualified personnel should thoroughly check and test it before installation.

# 5 Mechanical Mounting

## 5.1 Safety during Mounting

### DANGER

Make sure there is no electrical connection before installation.  
In order to avoid electric shock or other injury, make sure that holes will not be drilled over any electricity or plumbing installations.

### CAUTION

Risk of injury due to improper handling

- Always follow the instructions when moving and positioning the inverter.
- Improper operation may cause injuries or serious wounds.

In the case of poor ventilation, the system performance may compromise.

- Keep the heat sinks uncovered to ensure heat dissipation performance.

## 5.2 Location Requirements

Select an optimal mounting location for safe operation, long service life and expected performance.

- The inverter with protection rating IP65 can be installed both indoors and outdoors.
- Install the inverter at a place convenient for electrical connection, operation, and maintenance.

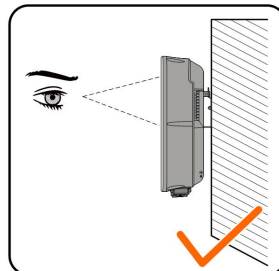
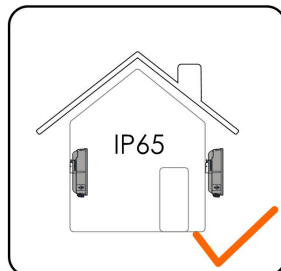

### 5.2.1 Environment Requirements

- The installation environment must be free of inflammable or explosive materials.
- The location should be not accessible to children.

- The ambient temperature and relative humidity must meet the following requirements.

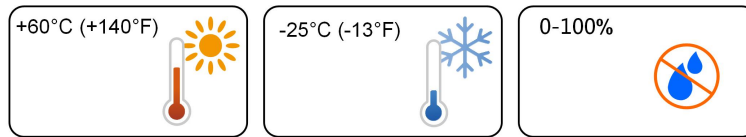

- Avoid direct exposure to sun, rain and snow.
- The inverter should be well ventilated. Ensure air circulation.
- Never install the inverter in living areas. The inverter will generate noise during operation, affecting daily life.

### 5.2.2 Carrier Requirements

The concrete wall should be capable of withstanding a force of four times the weight of the inverter and be suitable for the dimensions of the inverter.

The installation carrier should meet the following requirements:



S900-I003

### 5.2.3 Angle Requirements

Install the inverter vertically. Never install the inverter horizontally, or at forward/backward tilted, or upside down.

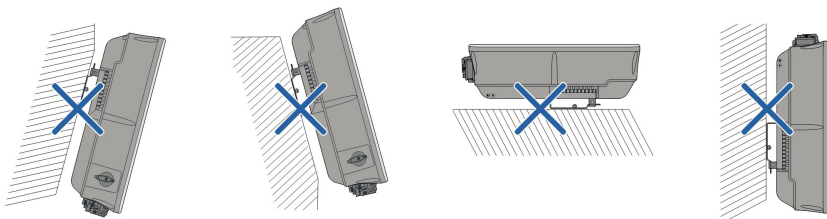

S900-I004

### 5.2.4 Clearance Requirements

Reserve enough clearance around the inverter to ensure sufficient space for heat dissipation.



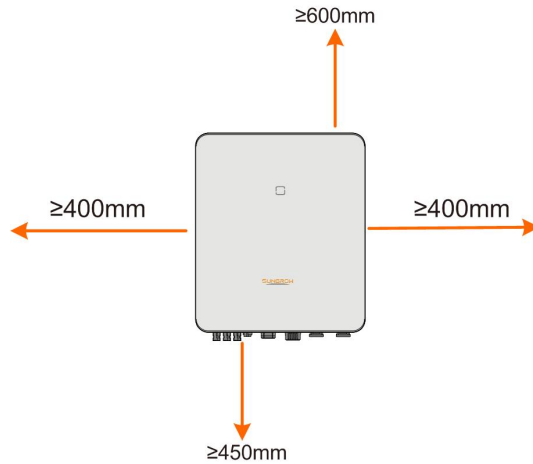

In case of multiple inverters, reserve specific clearance between the inverters.

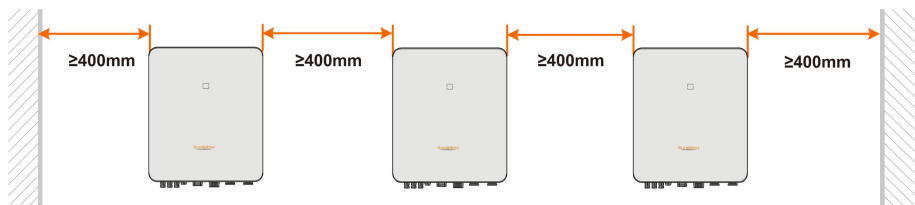

Install the inverter at an appropriate height for ease of viewing LED indicator and operating switch(es).

### 5.3 Installation Tools

Installation tools include but are not limited to the following recommended ones. If necessary, use other auxiliary tools on site.

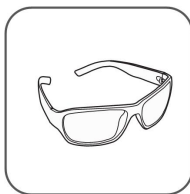

Goggles

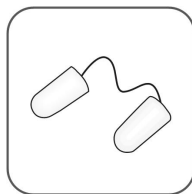

Earplugs

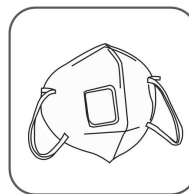

Dust mask



Protective gloves



Insulated shoes

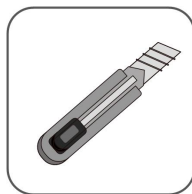

Utility knife

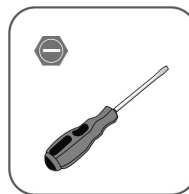

Slotted screwdriver  
(M4)



Phillips screwdriver  
(M4)



Hammer drill  
( $\varphi$  10)

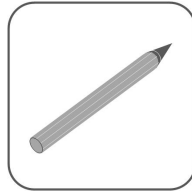

Marker



Vacuum cleaner

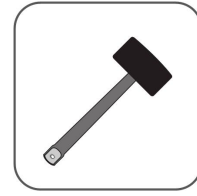

Rubber mallet



Wrist strap



Wire cutter

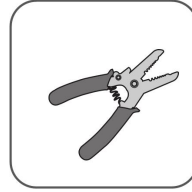

Wire stripper

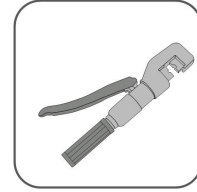

Hydraulic plier

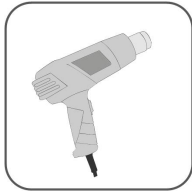

Heat gun



MC4 terminal  
crimping pliers  
4 – 6mm<sup>2</sup>

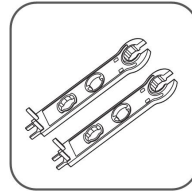

MC4 terminal  
wrench

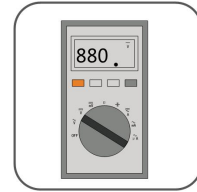

Multimeter  
 $\geq$  1000V DC

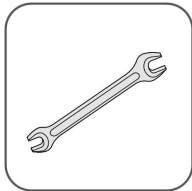

Wrench  
(16 mm, 46 mm)

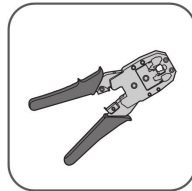

RJ45 crimping tool

## 5.4 Moving the Inverter

Before installation, remove the inverter from the packing case and move it to the installation site. Follow the instructions below as you move the inverter:

- Always be aware of the weight of the inverter.
- Lift the inverter using the handles positioned on both sides of the inverter.
- Move the inverter by one or two people or by using a proper transport tool.
- Do not release the equipment unless it has been firmly secured.

## 5.5 Installing the Inverter

Install the inverter on the wall using the provided wall-mounting bracket and expansion plug sets.

The expansion plug set shown below is recommended for the installation.

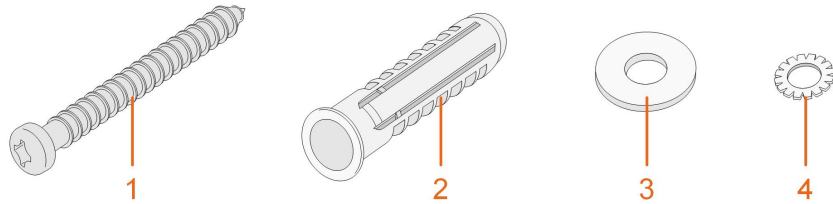

(1) Self-tapping screw    (2) Expansion tube    (3) Fender washer    (4) Spring washer  
screw

**step 1** Install the wall-mounting bracket.

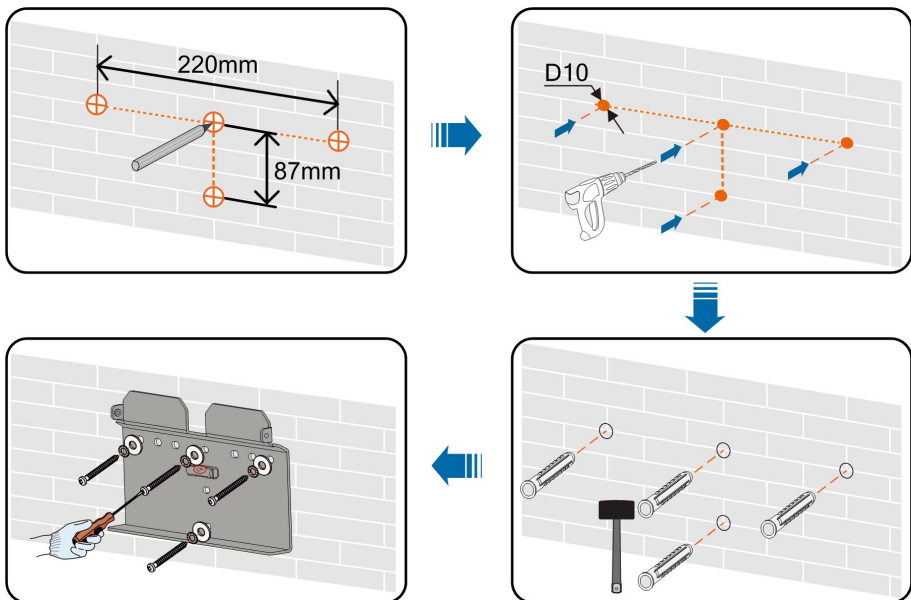

Note:

- 1 The depth of the holes should be about 70 mm.
- 2 The air bubble in the bracket must be between the two lines in the red circles to ensure the horizontal level.

**step 2** Mount the inverter to the bracket. Secure the inverter with two M4 screws and washers. (1.5 N•m)

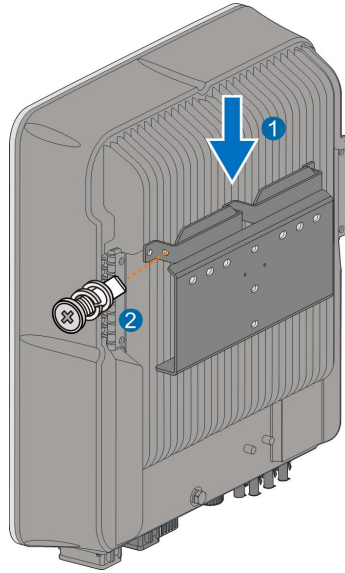

-- End

# 6 Electrical Connection

## 6.1 Safety Instructions

Prior to any electrical connections, keep in mind that the inverter has dual power supplies. It is mandatory for the qualified personnel to wear personal protective equipments (PPE) during the electrical work.

### DANGER

**Danger to life due to a high voltage inside the inverter!**

- The PV string will generate lethal high voltage when exposed to sunlight.
- Before starting electrical connections, disconnect the DC and AC circuit breakers and prevent them from inadvertent reconnection.
- Ensure that all cables are voltage free before performing cable connection.

### WARNING

- Any improper operations during cable connection can cause device damage or personal injury.
- Only qualified personnel can perform cable connection.
- All cables must be undamaged, firmly attached, properly insulated and adequately dimensioned.

### NOTICE

Comply with the safety instructions related to the PV strings and the regulations related to the utility grid.

- All electrical connections must be in accordance with local and national standards.
- Only with the permission of the local utility grid company, the inverter can be connected to the utility grid.

## 6.2 Terminal Description

All electrical terminals are located at the bottom of the inverter.

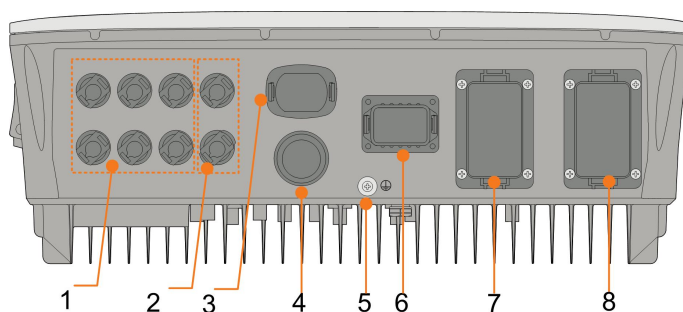

figure 6-1 Terminals at the Bottom of the Inverter

\* The image shown here is for reference only. The actual product received may differ.

No.	Name	Description
1	PV terminals	Positive and negative DC input connectors Two or three pairs, depending on the inverter model
2	Battery connection	Connectors for the battery power cables
3	WLAN terminal	Connector for the WiNet—S module
4	LAN terminal	Connector for the EMS, router, and data logger
5	Additional grounding terminal	For reliable grounding
6	COM terminal	Connector for Smart Energy Meter, RS485, BMS/CAN, DRM/DI and DO
7	BACK-UP terminal	AC terminal reserved for Backup loads
8	GRID terminal	AC terminal for connection to the utility grid

table 6-1 The label of COM terminal

Meter		BMS/CAN		DI/DRM			DO
A2	B2	H	L	D1/5	D3/7	R	NO
A1	B1	EN_H	EN_G	D2/6	D4/8	C	COM
RS485		Enable					

table 6-2 The label description of COM terminal

No.	Label	Description
1	Meter (A2, B2) (1)	<ul style="list-style-type: none"> <li>Connect to the Smart Energy Meter. (If installing a single inverter or if installing the master inverter in a string of parallel inverters.)</li> <li>Enable the communication between inverters in parallel. (If installing a slave inverter in a string of parallel inverters.)</li> </ul>
2	RS485 (A1, B1) (1) (2)	<ul style="list-style-type: none"> <li>Connect to the LG Chem Li-ion battery, use with Enable terminal</li> <li>Connect to an external device to receive the command to shut down the inverter remotely (Italy only) or enable the communication between inverters in parallel. (If installing a master inverter in a string of parallel inverters.)</li> </ul>
3	BMS/CAN	To enable the communication between the inverter and the Li-ion battery
4	Enable	Connect to the LG Chem Li-ion battery, use with RS485 terminal
5	DI/DRM	<ul style="list-style-type: none"> <li>"AU"/"NZ": Demand response enabling device (DRED)</li> <li>"IT": interface protection system (SPI)</li> <li>"DE": Ripple Control Receiver (RCR)</li> </ul>
6	DO	<ul style="list-style-type: none"> <li>Connect to an external light indicator and/or buzzer to signal an alarm.</li> <li>Connect to home load (such as SG Ready Heat Pump) for power management.</li> </ul>

(1) When the inverter is connected to a third-party monitoring device, please confirm which communication interface is used, and whether it will cause loss of certain functions of the inverter.

(2) When RS485 (A1, B1) is used for parallel connection in the master inverter, the LG Chem battery (that uses RS485 for communication) cannot be used with the master inverter. It can still be used with the slave inverter.

### 6.3 Electrical Connection Overview

#### System Wiring Diagram

The electrical connection should be realized as follows:

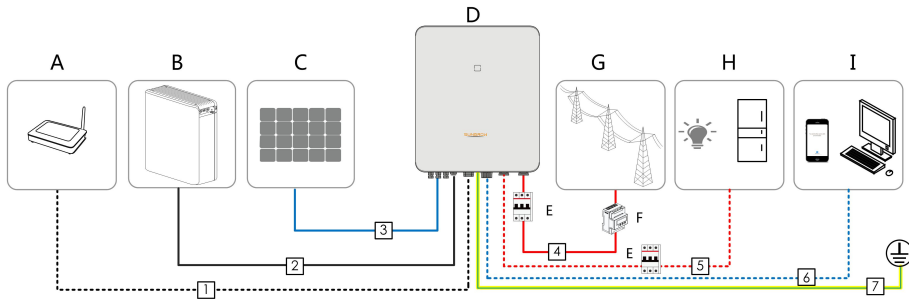

- (A) Router                      (B) Battery                      (C) PV string  
 (D) Inverter                    (E) AC circuit breaker        (F) Smart Energy Meter  
 (G) Grid                        (H) Backup loads              (I) Monitoring device

table 6-3 Cable requirements

No.	Cable	Type	Specification	
			Outer diameter	Cross section
1	Ethernet cable	CAT 5E outdoor shielded network cable	5.3 ~ 7 mm	8 * 0.2 mm <sup>2</sup>
2	Power Cable	Complying with 1,000V and 35A standard	5.5 ~ 8 mm	4 mm <sup>2</sup>
		Complying with 1,000V and 40A standard		6 mm <sup>2</sup>
3	DC cable	Outdoor multi-core copper wire cable Complying with 1,000V and 30A standard	6 ~ 9 mm	4 ~ 6 mm <sup>2</sup>
4	AC cable *	Outdoor multi-core copper wire cable	14 ~ 25 mm	6 ~ 10 mm <sup>2</sup>
5			12 ~ 14mm	4 ~ 6 mm <sup>2</sup>
6	Communication cable	Shielded twisted pair	5.3 ~ 7 mm	2 * (0.5 ~ 1.0) mm <sup>2</sup>
		CAT 5E outdoor shielded network cable		8 * 0.2 mm <sup>2</sup>
7	Additional Grounding cable *	Outdoor single-core copper wire cable	The same as that of the PE wire in the AC cable	

\* If local regulations have other requirements for cables, set the cable specification according to the local regulations.

### Backup Wiring Diagram

For Australia and New Zealand, the neutral cable of GRID side and BACK-UP side must be connected together according to the wiring rules AS/NZS\_3000. Otherwise BACK-UP function will not work.



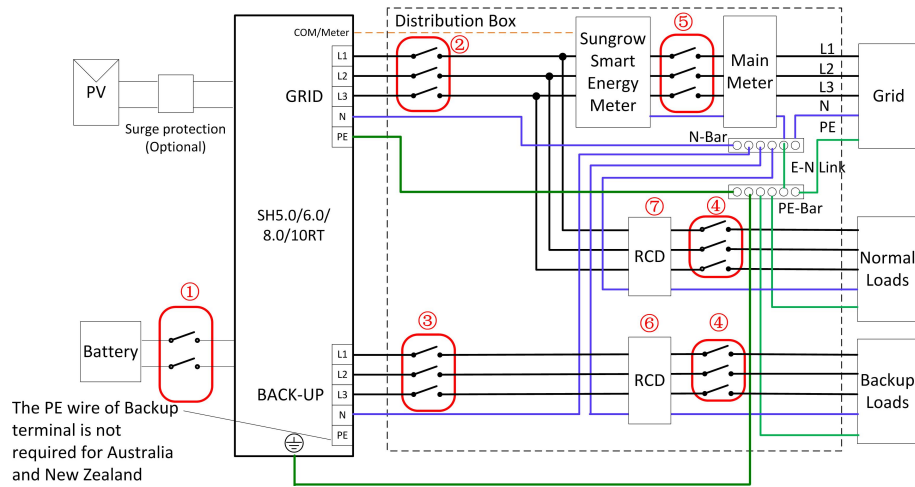

NO.	SH5.0/6.0RT	SH8.0/10RT
①	40A/600V DC breaker *	
②	25A/400V AC breaker	32A/400V AC breaker
③	25A/400V AC breaker	
④	Depends on loads	
⑤	Depends on household loads and inverter capacity	
⑥⑦	30mA RCD (Comply with local regulation)	

Note: \* If the battery is integrated with a readily accessible internal DC breaker, no additional DC breaker is required.

Note: The values in the table are recommended values and can be set to other values according to actual conditions.

For other countries, the following diagram is an example for grid systems without special requirement on wiring connection.

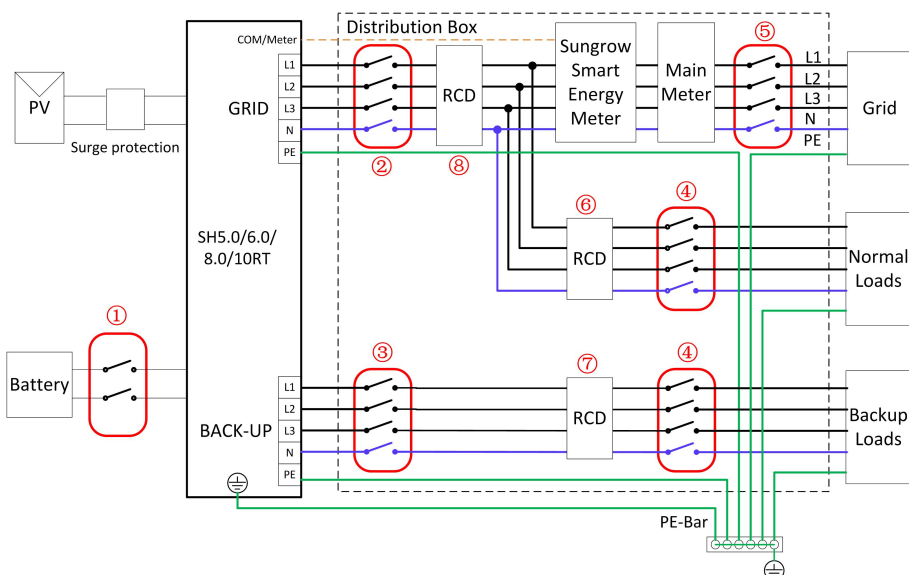

NO.	SH5.0/6.0RT	SH8.0/10RT
①	40A/600V DC breaker *	
②	25A/400V AC breaker	32A/400V AC breaker
③	25A/400V AC breaker	
④	Depends on loads	
⑤	Depends on household loads and inverter capacity (Optional)	
⑥⑦	30mA RCD (Recommended)	
⑧	300mA RCD (Recommended)	

Note: \* If the battery is integrated with a readily accessible internal DC breaker, no additional DC breaker is required.

Note: The values in the table are recommended values and can be set to other values according to actual conditions.

In the TT system, the following diagram is an example for grid systems without special requirement on wiring connection.

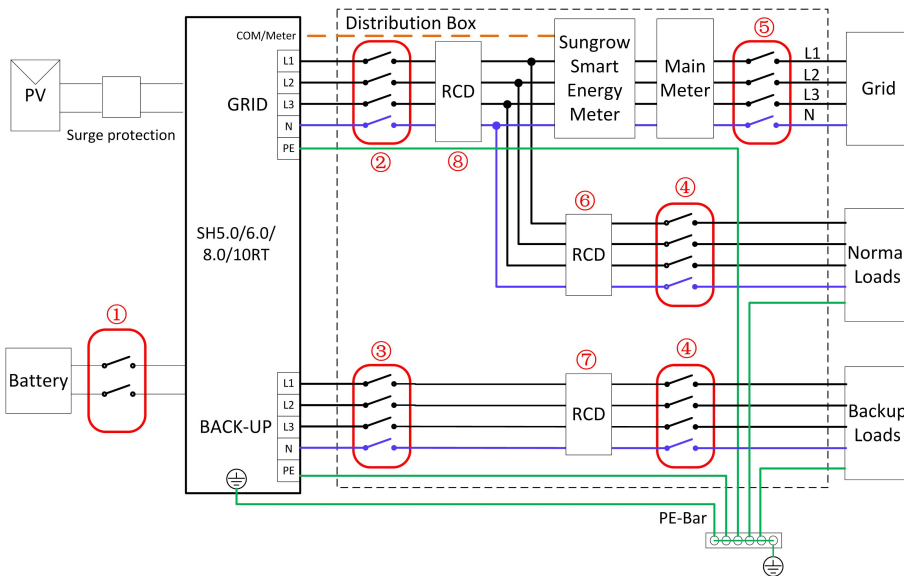

NO.	SH5.0/6.0RT	SH8.0/10RT
①	40A/600V DC breaker *	
②	25A/400V AC breaker	32A/400V AC breaker
③	25A/400V AC breaker	
④	Depends on loads	
⑤	Depends on household loads and inverter capacity	
⑥⑦	30mA RCD (Recommended)	
⑧	300mA RCD (Recommended)	

Note: \* If the battery is integrated with a readily accessible internal DC breaker, no additional DC breaker is required.

Note: The values in the table are recommended values and can be set to other values according to actual conditions.

## 6.4 Additional Grounding Connection

### WARNING

- Since the inverter is transformerless, neither the negative pole nor the positive pole of the PV string must be grounded. Otherwise, the inverter will not operate normally.
- Connect the additional grounding terminal to the protective grounding point before AC cable connection, PV cable connection, and communication cable connection.
- The ground connection of this additional grounding terminal cannot replace the connection of the PE terminal of the AC cable. Make sure those terminals are both grounded reliably. SUNGROW shall not be held liable for any damage caused by the violation.

### 6.4.1 Additional Grounding Requirements

All non-current carrying metal parts and device enclosures in the PV power system should be grounded, for example, mounts of PV modules and the inverter enclosure.

When there is only one inverter in the PV system, connect the additional grounding cable to a nearby grounding point.

When there are multiple inverters in the PV system, connect grounding points of all inverters and the PV array frames to the equipotential cable (according to the onsite conditions) to implement an equipotential connection.

### 6.4.2 Connection Procedure

There are two additional grounding terminals located at the bottom and right side of the inverter. Connect either one.

Additional grounding cable is prepared by customers.

**step 1** Prepare the cable and OT/DT terminal.

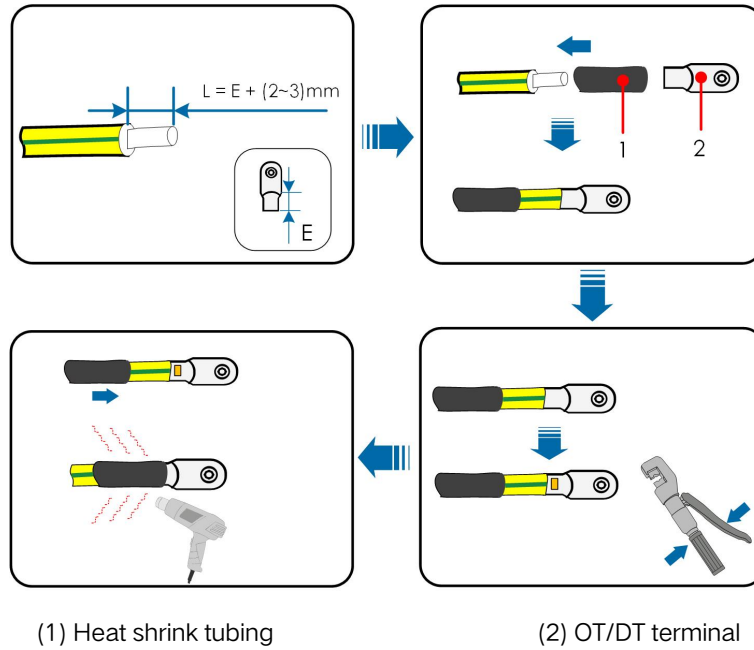

**step 2** Remove the screw on the grounding terminal and fasten the cable with a screwdriver.

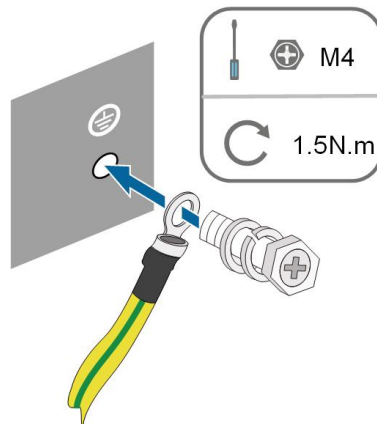

**step 3** Apply paint to the grounding terminal to ensure corrosion resistance.

-- End

## 6.5 AC Cable Connection

### 6.5.1 AC Side Requirements



Connect the inverter to the grid only after getting an approval from the local electric power company.

Before connecting the inverter to the grid, ensure the grid voltage and frequency comply with requirements, for which, refer to "**Technical Data**". Otherwise, contact the electric power company for help.

### AC Circuit Breaker

An independent three or four-pole circuit breaker must be installed on the output side of the inverter to ensure safe disconnection from the grid.

Inverter Model	Recommended Specification
SH5.0RT	25 A
SH6.0RT	
SH8.0RT	32 A
SH10RT	

#### NOTICE

- Determine whether an AC circuit breaker with greater overcurrent capacity is required based on actual conditions.
- Multiple inverters cannot share one circuit breaker.
- Never connect a load between the inverter and the circuit breaker.

### Residual Current Monitoring Device

With an integrated universal current-sensitive residual current monitoring unit included, the inverter will disconnect immediately from the mains power once a fault current with a value exceeding the limit is detected.

However if an external residual current device (RCD) is mandatory, the switch must be triggered at a residual current of 300 mA (recommended), or it can be set to other values according to local regulations. For example in Australia, the inverter can use an additional 30 mA (type A) RCD in installations.

## 6.5.2 Assembling the AC Connector

The AC terminal block is on the bottom side of the inverter. AC connection is the three-phase-four-wire grid + PE connection (L1, L2, L3, N, and PE).

**step 1** Unscrew the swivel nut of the AC connector.

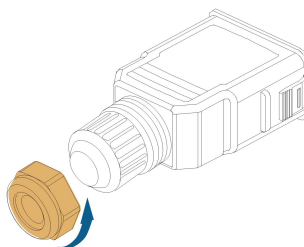

**step 2 (Optional)** Remove the inner sealing ring if the cable diameter is between 19 mm ~ 25 mm. Otherwise skip this step.

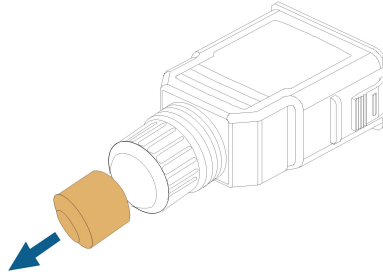

**step 3** Take out the terminal plug from the housing.

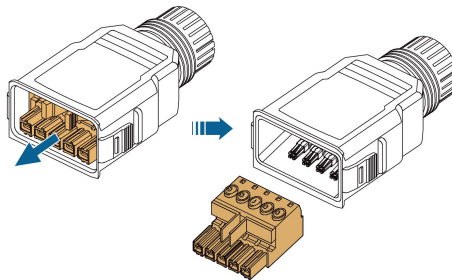

**step 4** Thread the AC cable of appropriate length through the swivel nut and the housing.

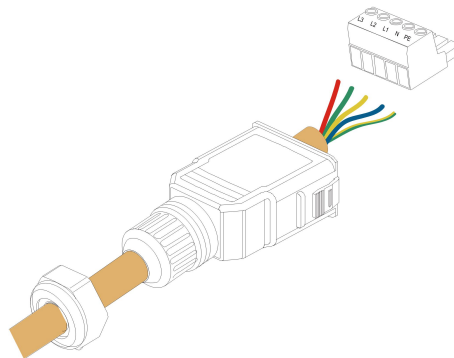

**step 5** Strip 80 mm ~ 90 mm of the cable jacket and 12 mm of the wire insulation.

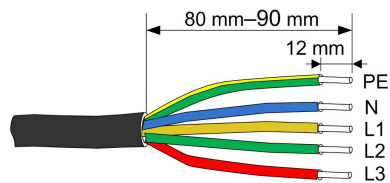

**step 6 (Optional)** When using a multi-core multi-strand copper wire cable, connect the AC wire head to the cord end terminal (hand-tight). In case of single-strand copper wire, skip this step.

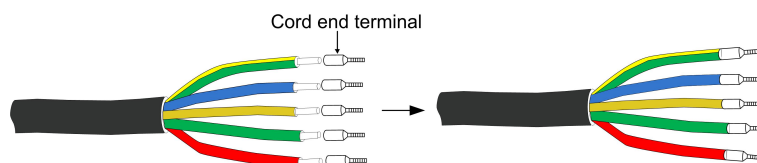



Select appropriate cord end terminal according to the cable cross-section area.

**step 7** Fix all the wires to the terminal plug according to the assignment and tighten to a torque of 1.2 N•m – 1.5 N•m with a screwdriver. Then push the terminal plug into the housing until there is an audible click.

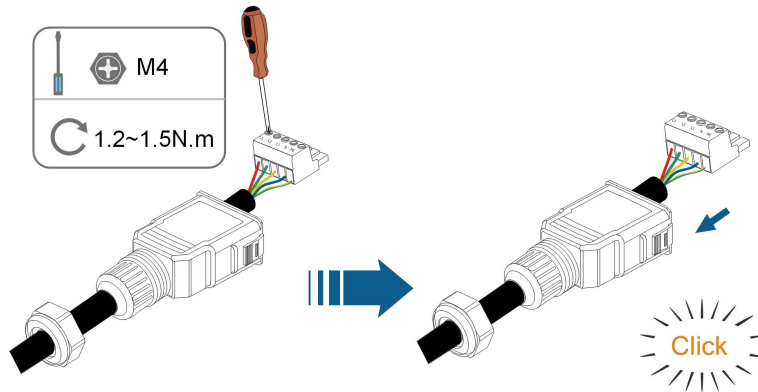

#### NOTICE

Observe the plug assignment. Do not connect any phase line to the "PE" terminal or the PE wire to the "N" terminal. Otherwise, unrecoverable damage to the inverter may follow.

**step 8** Ensure that the wires are securely in place by slightly pulling them. Tighten the swivel nut to the housing.

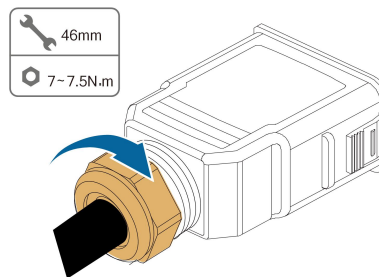

-- End

### 6.5.3 Installing the AC Connector

#### **⚠ DANGER**

High voltage may be present in inverter!

Ensure all cables are voltage-free before electrical connection.

Do not connect the AC circuit breaker until all inverter electrical connections are completed.

**step 1** Disconnect the AC circuit breaker and secure it against reconnection.

**step 2** Remove the waterproof lid from the **GRID** terminal.

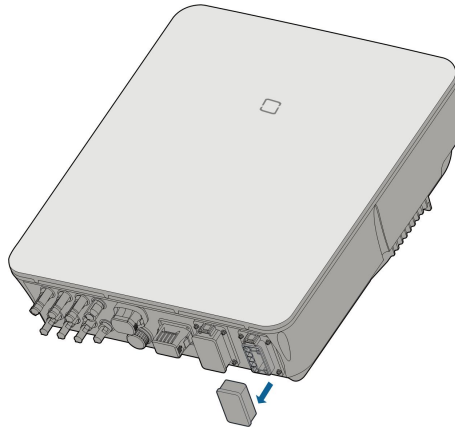

**step 3** Insert the AC connector into the **GRID** terminal on the bottom of the inverter until there is an audible sound.

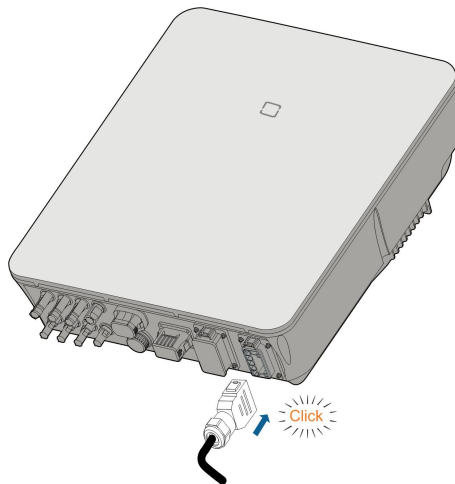

**step 4 (Optional)** Insert the block into AC connector, as shown in the figure below.

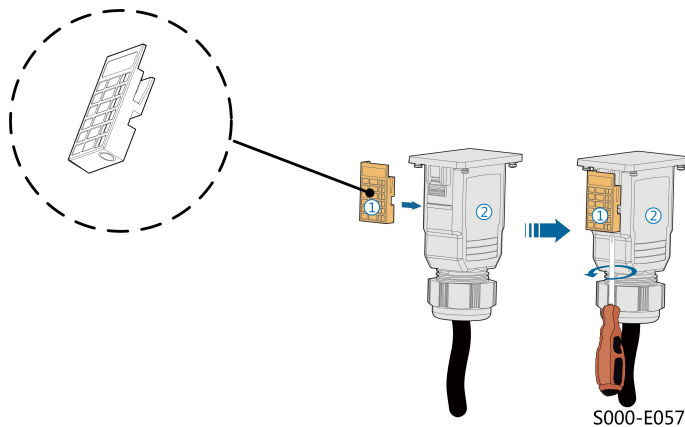



- 1 Insert block ① into AC connector ② from the side.
- 2 Tighten the screw on the bottom of block ①.

**step 5** Connect PE cable to ground.

**step 6** Connect phase cable and “ N ” cable to AC circuit breaker.

**step 7** Connect AC circuit breaker to utility grid.

**step 8** Make sure all AC cables are firmly installed via the right torque tool or dragging the cables slightly.

-- End

## 6.6 DC Cable Connection

### DANGER

Danger of electric shock!

The PV array will generate lethal high voltage once exposed to sunlight.

### WARNING

Make sure the PV array is well insulated to ground before connecting it to the inverter.

### WARNING

Before connecting the PV array to the inverter, ensure that the impedances between the positive terminals of the PV string and earth, and between the negative terminals of the PV string and earth are larger than 1 M Ohm.

### NOTICE

Risk of inverter damage! Observe the following requirements. Failure to do so will void guarantee and warranty claims.

- Make sure the maximum DC voltage and the maximum short circuit current of any string never exceed inverter permitted values specified in "Technical Data".
- Mixed use of different brand or model of PV modules in a PV string or a compromised PV string design composed with PV modules from rooftops of different orientation may not damage inverter but will cause system bad performance!

### 6.6.1 PV Input Configuration

In Australia and New Zealand, ensure the DC power for any PV string never exceeds a certain level with regards to the string voltage to avoid derating:

≤ 12.5 kW if string voltage is lower than 500 V

≤ 10 kW if string voltage is between 500 V and 800 V

≤ 8 kW if string voltage is between 800 V and 1000 V

For SH5.0/6.0/8.0RT, each PV input operates independently and has its own MPPT. In this way, string structures of each PV input may differ from each other, including PV module type, number of PV modules in each string, angle of tilt, and installation orientation.

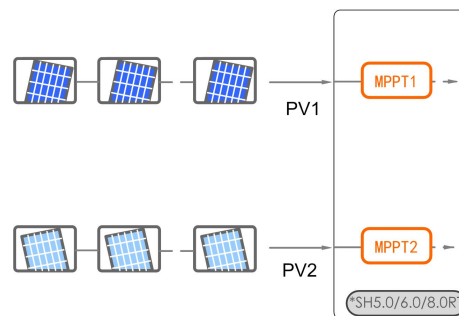

For SH10RT, each pair of PV terminals is corresponding to an independent PV string. PV input PV1 connect to MPPT1 and PV2, PV3 connect to MPPT2. For the best use of PV power, PV2 and PV3 should be the same in PV string structure, including the type, number, tilt, and orientation of the PV modules.

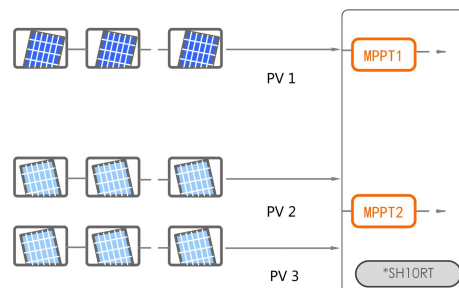

For SH10RT, if two PV strings are paralleled externally, the paralleled strings can be connected to PV2 or PV3 only, and the other one cannot be used to connect other PV strings.

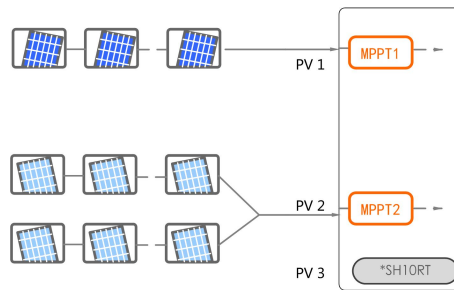

Prior to connecting the inverter to PV inputs, the following electrical specifications must be met simultaneously:

Model	Open-circuit Voltage Limit	Max. current for Input Connector
SH5.0RT	1000 V	30 A
SH6.0RT		
SH8.0RT		
SH10RT		

## 6.6.2 Assembling the PV Connectors

### **⚠ DANGER**

High voltage may be present in the inverter!

- Ensure all cables are voltage-free before performing electrical operations.
- Do not connect the AC circuit breaker before finishing electrical connection.



SUNGROW provides corresponding PV connectors in the scope of delivery for quick connection of PV inputs. To ensure IP65 protection, use only the supplied connector or the connector with the same ingress of protection.

**step 1** Strip the insulation from each DC cable by 7 mm – 8 mm.

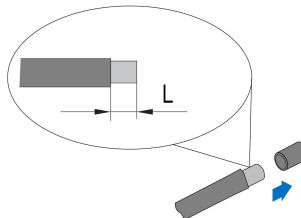

**step 2** Assemble the cable ends with the crimping pliers.

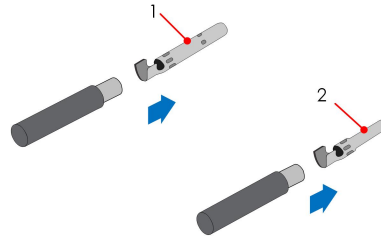

1: Positive crimp contact

2: Negative crimp contact

**step 3** Lead the cable through cable gland, and insert the crimp contact into the insulator until it snaps into place. Gently pull the cable backward to ensure firm connection. Tighten the cable gland and the insulator (torque 2.5 N.m to 3 N.m).

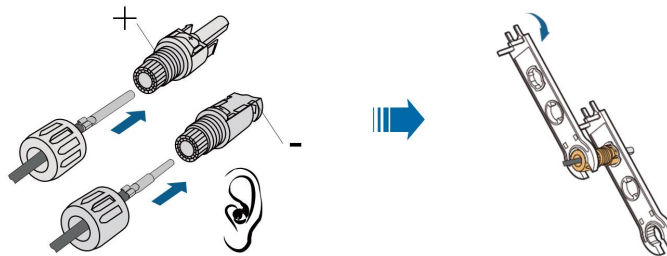

**step 4** Check for polarity correctness.

#### NOTICE

If the PV polarity is reversed, the inverter will be in a fault or alarm state and will not operate normally.

-- End

### 6.6.3 Installing the PV Connector

**step 1** Rotate the DC switch to "OFF" position.

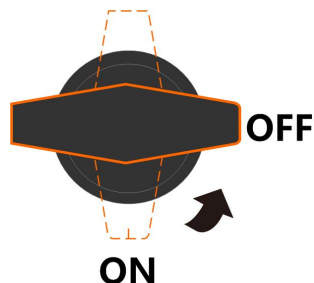

**step 2** Check the cable connection of the PV string for polarity correctness and ensure that the open circuit voltage in any case does not exceed the inverter input limit of 1,000V.

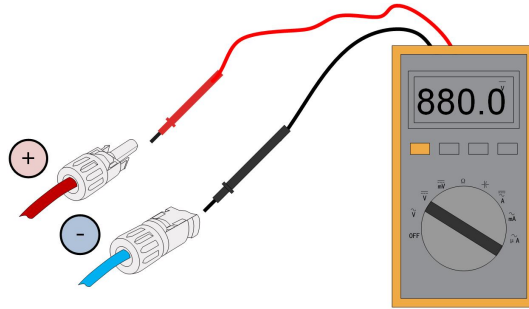

**step 3** Connect the PV connectors to corresponding terminals until there is an audible click.

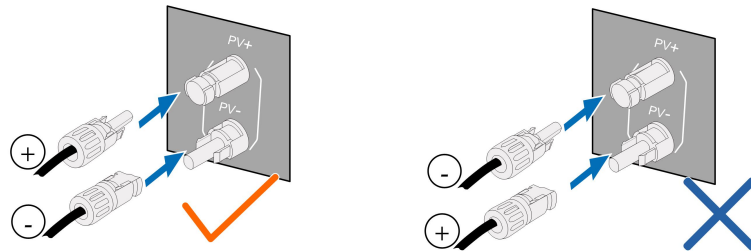

#### NOTICE

- Check the positive and negative polarity of the PV strings, and connect the PV connectors to corresponding terminals only after ensuring polarity correctness.
- Arc or contactor over-temperature may occur if the PV connectors are not firmly connected in place, and SUNGROW shall not be held liable for any damage caused due to this operation.

**step 4** Follow the foregoing steps to connect PV connectors of other PV strings.

**step 5** Seal any unused PV terminal with a terminal cap.

#### NOTICE

If the DC input is connected inversely and the DC switch has been rotated to "ON", do not operate immediately. Otherwise, the equipment may be damaged. Please turn the DC switch to "OFF" and remove the DC connector to adjust the polarity of the strings when the string current is lower than 0.5A.

-- End

## 6.7 Communication Connection

### LAN function

- Through the Modbus TCP/IP protocol, the EMS or the Logger from the third party can fully control the on/off, derating, charging and discharging of the inverter.
- **(Optional)** The inverter operation information can be transferred to the iSolarCloud server via the router.

### WLAN function

With the WiNet-S module installed, view corresponding information through iSolarCloud App or iSolarCloud Web.

### RS485 function

The RS485 communication interfaces are used to establish communication connection with monitoring devices.

### 6.7.1 Ethernet Connection

The following figure shows how the Ethernet connection may work with a router.

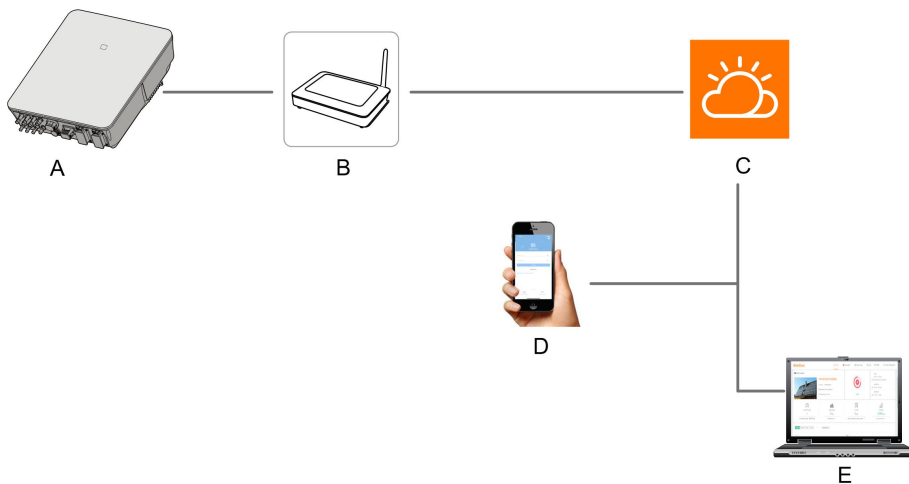

**figure 6-2** Ethernet Connection with a Router

(A) Inverter

(B) Router/Switch

(C) iSolarCloud server

(D) iSolarCloud App

(E) iSolarCloud

#### 6.7.1.1 Assembling the LAN Connector



Skip step 1 if the standard network cable with RJ45 plug is prepared.

**step 1 (Optional)** Strip the insulation layer of the communication cable with an Ethernet wire stripper, and lead the corresponding signal cables out. Insert the stripped communication cable into the RJ45 plug in the correct order, and crimp it with a crimper.

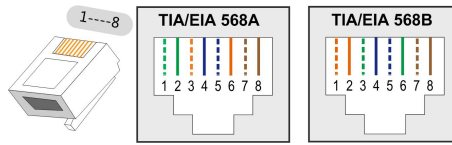

**step 2** Unscrew the swivel nut from the connector.

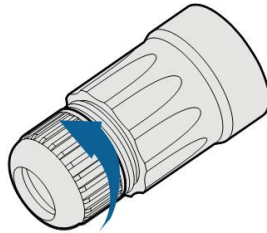

**step 3** Remove the inner rubber gasket.

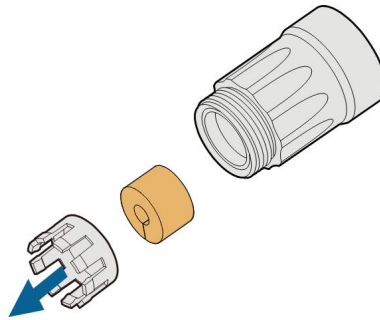

**step 4** Insert the RJ45 plug into the front plug connector until there is an audible click, and install the rubber gasket.

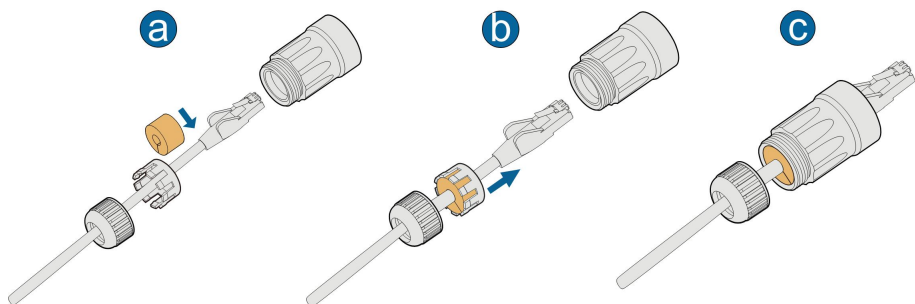

-- End

### 6.7.1.2 Installing the LAN Connector

**step 1** Unscrew the waterproof lid from the LAN terminal.

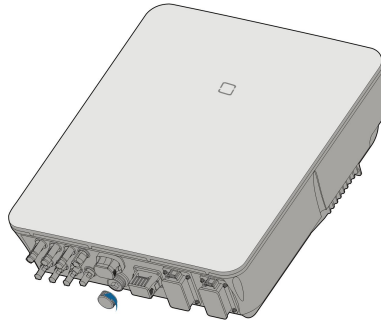

**step 2** Insert the LAN connector into **LAN** terminal on the bottom of the inverter.

**step 3** Pull cables outwards to confirm whether they are fastened firmly, then tighten the swivel nut with appropriate torque.

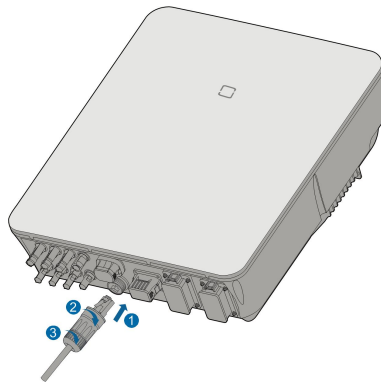

-- End

### 6.7.2 WiNet-S Connection

The WiNet-S module supports Ethernet communication and WLAN communication. It is not recommended to use both communication methods at the same time.

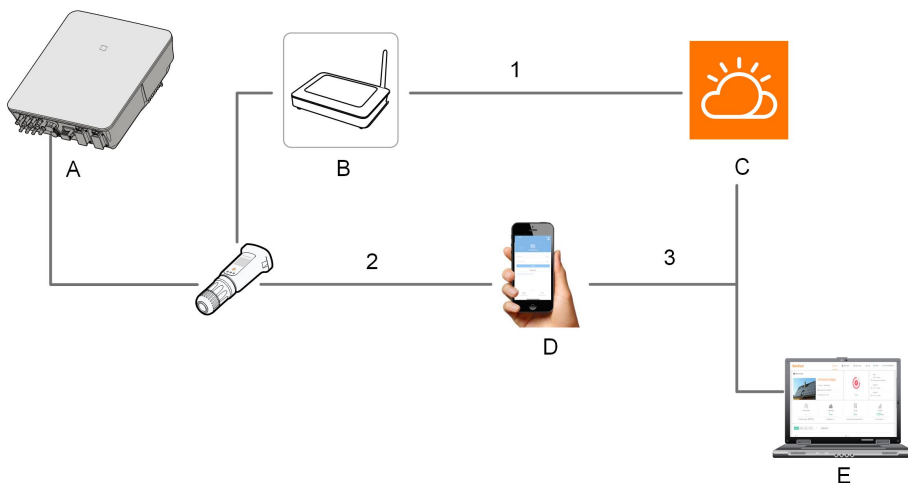



- |                     |                   |                        |
|---------------------|-------------------|------------------------|
| (A) Inverter        | (B) Router/Switch | (C) iSolarCloud server |
| (D) iSolarCloud App | (E) iSolarCloud   |                        |
| (1) Internet        | (2) Local access  | (3) Remote             |

For details, see the quick guide for the WiNet-S module. Scan the following QR code for the quick guide.



### 6.7.2.1 Ethernet Communication

**step 1 (Optional)** Strip the insulation layer of the communication cable with an Ethernet wire stripper, and lead the corresponding signal cables out. Insert the stripped communication cable into the RJ45 plug in the correct order, and crimp it with a crimper.

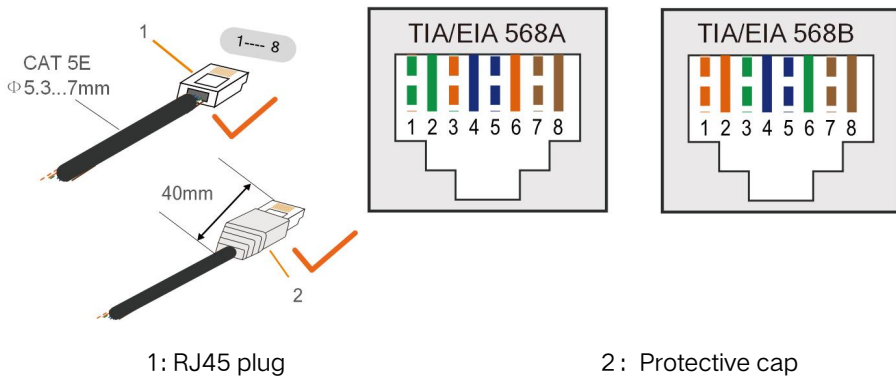

Skip this step if a standard network cable with RJ45 plug is prepared.

**step 2** Unscrew the swivel nut from the communication module and take out the inner sealing ring.

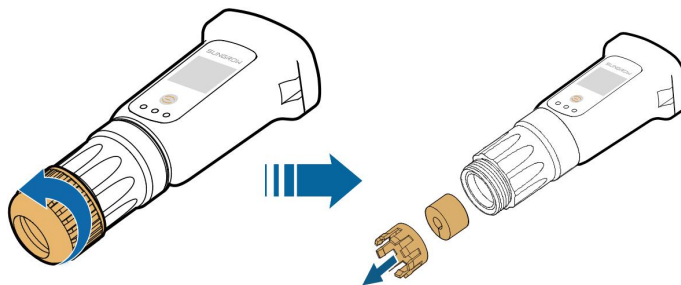

**step 3** Unscrew the housing from the communication module.

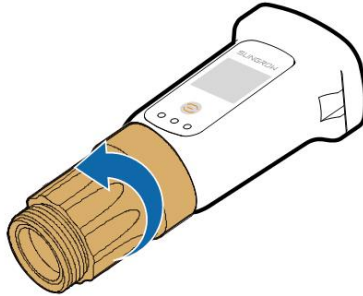

**step 4** Thread the network cable through the swivel nut and gasket. Afterwards, route the cable into the opening of the sealing. Finally, insert the cable through the housing.

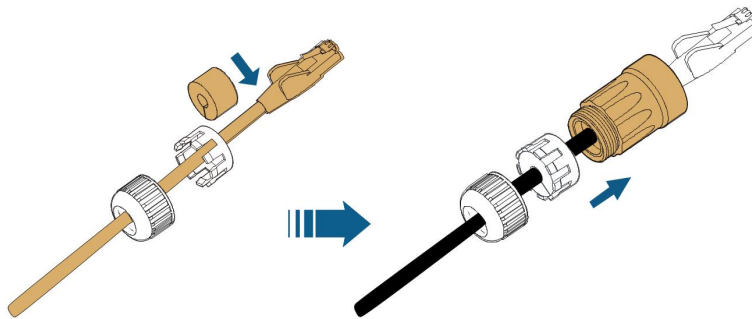

**step 5** Insert the RJ45 plug into the front plug connector until there is an audible click and tighten the housing. Install the gasket and fasten the swivel nut.

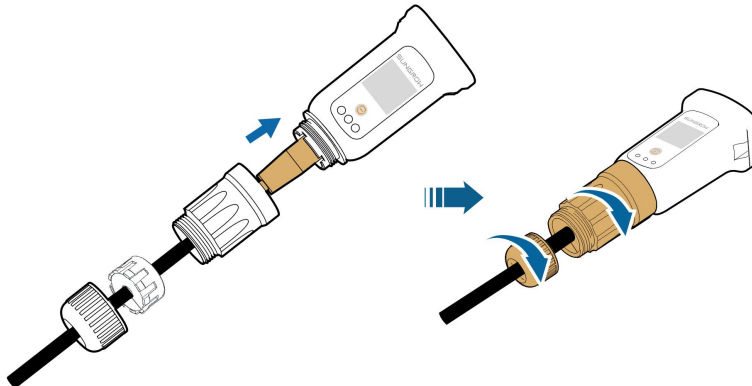

**step 6** Remove the waterproof lid from the **WLAN**terminal and install WiNet-S.

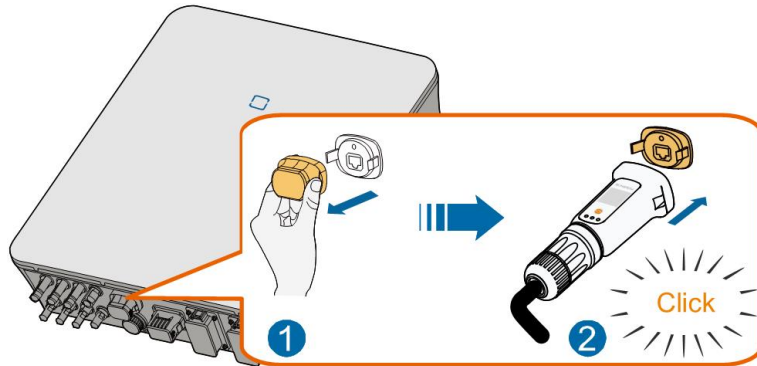

**step 7** Slightly shake it by hand to determine whether it is installed firmly.

-- End

### 6.7.2.2 WLAN Communication

**step 1** Remove the waterproof lid from the **WLAN** terminal.

**step 2** Install the module. Slightly shake it by hand to determine whether it is installed firmly, as shown below.

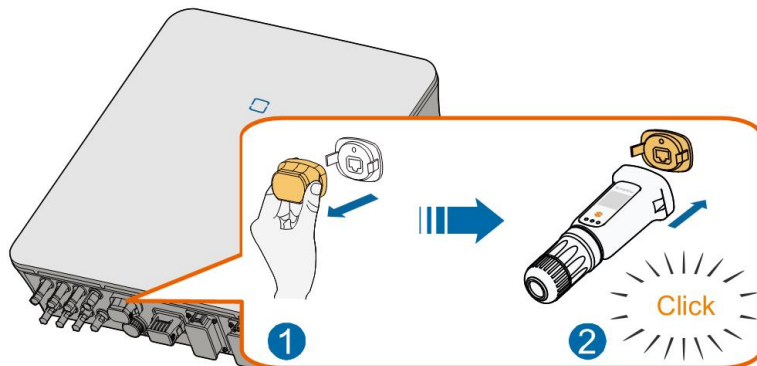

**step 3** Refer to the guide delivered with the module for the set-up.

-- End

### 6.7.3 RS485 Connection

Where there is only one inverter, the RS485 can be connected to an external device for the communication.

Where there are two or more inverters in parallel, the RS485 connection enables the communication between master inverter and slave inverter, as shown in the following figure.

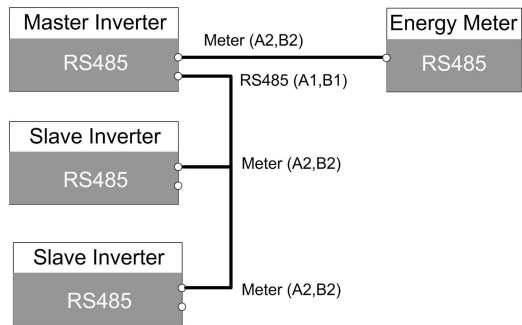

### 6.7.3.1 Assembling the COM Connector

**step 1** Unscrew the swivel nut from the connector.

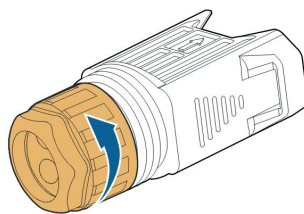

**step 2** Take out the terminal block.

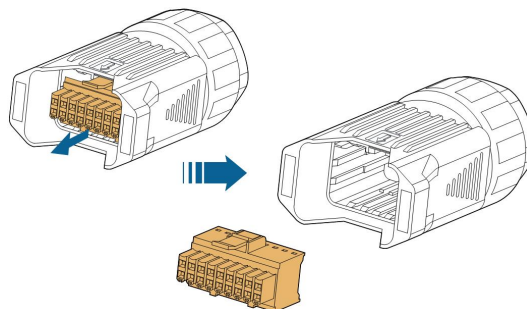

**step 3** Remove the seal and lead the cable through the cable gland.

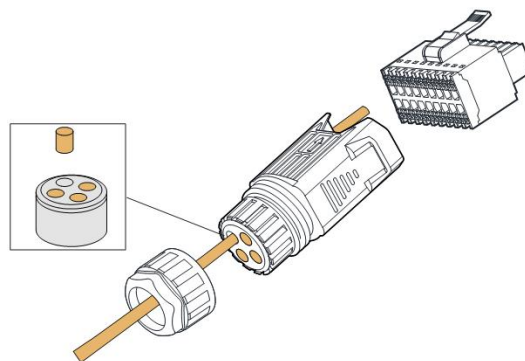

**step 4** Remove the cable jacket and strip the wire insulation.

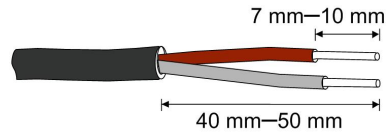

**step 5** Plug the wires into the **RS485** terminal according the labels on the bottom of the inverter.

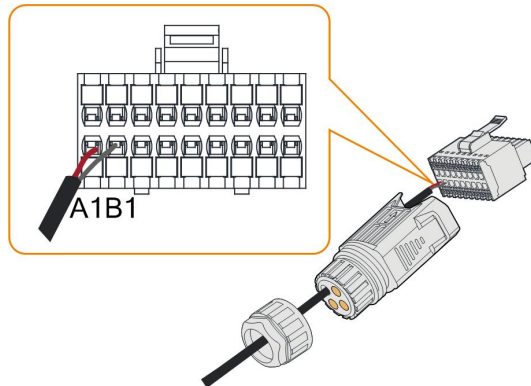

**step 6** Pull the wires outward to check whether they are firmly installed.

**step 7** Insert the terminal block into the connector until it snaps into place with an audible click.

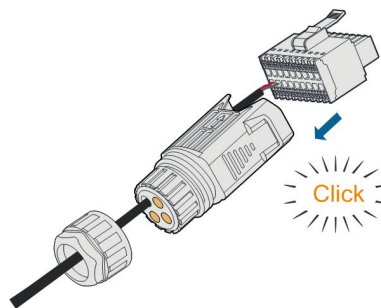

**step 8** Fasten the swivel nut.

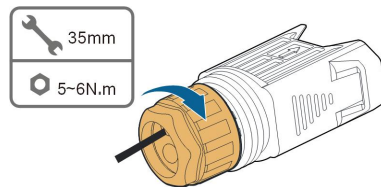

-- End

### 6.7.3.2 Installing the COM Connector

**step 1** Remove the waterproof lid from the **COM** terminal.

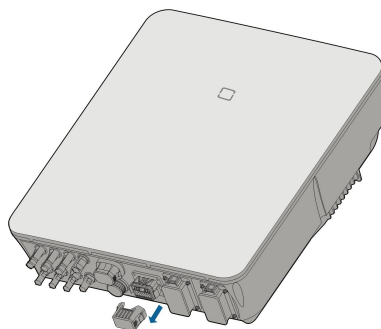

**step 2** Insert the COM connector into **COM** terminal on the bottom of the inverter until there is an audible click.

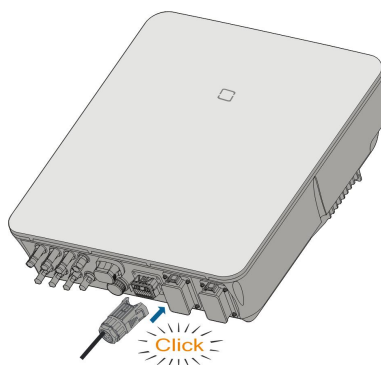

-- End

## 6.8 Smart Energy Meter Connection

The inverter is equipped with the feed-in power limit function, so as to meet the requirements of some national standards or grid standards for the output power at the grid connection point. For the setting of feed-in power limit, refer to the section "[8.5.1 Feed-in Limitation](#)".

Contact SUNGROW to ensure that the Smart Energy Meter model is available locally.



This section mainly describes the cable connections on the inverter side. Refer to the quick guide delivered with the Smart Energy Meter for the connections on the meter side.

### Procedure

For detailed connection description of the Smart Energy Meter cable, refer to the section "[6.7.3 RS485 Connection](#)". Plug the wires into the **Meter** terminal according to the labels on the bottom of the inverter.

## 6.9 Battery Connection

This section mainly describes the cable connections on the inverter side. Refer to the instructions supplied by the battery manufacturer for the connections on the battery side and configuration.

### WARNING

Only use properly insulated tools to prevent accidental electric shock or short circuits. If insulated tools are not available, use electrical tape to cover the entire exposed metal surfaces of the available tools except their tips.

### WARNING

The plug connector must be connected only by trained electricians.

### WARNING

**Do not disconnect under load!**  
Battery connectors must not be disconnected while under load. They can be placed in a no load state by shutting down the inverter completely.

### 6.9.1 Connecting the Power Cable

A fuse with the specification of 700 V / 50 A is integrated to the **BAT-** terminal.

#### NOTICE

A two-pole DC circuit breaker with over-current protection (voltage rating not less than 600 V and current rating not less than 40 A) should be installed between the inverter and the battery.

If the battery is integrated with a readily accessible internal DC breaker, no additional DC breaker is required.

All power cables are equipped with water-proof direct plug-in connectors, which match the battery terminals at the bottom of the inverter.

#### 6.9.1.1 Assembling the SUNCLIX Connector

#### NOTICE

During assembly, be careful not to contaminate, pull out, or shift, the seal in the cable gland. A contaminated or shifted seal impairs strain relief and leak tightness.

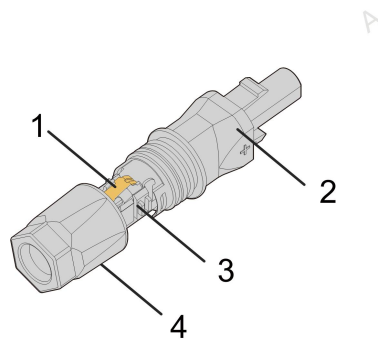

figure 6-3 SUNCLIX Connector Components

1 : Spring

2: Sleeve

3: Insert

4: Cable gland

**step 1** Strip the insulation from the cable by 15 mm.

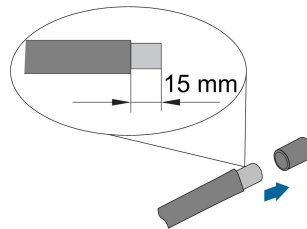

**step 2** Pry the connection open and pull the sleeve and the insert apart.

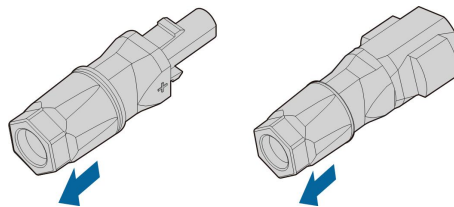

**step 3** Insert the stripped cable into the cable gland up to the stop. The stranded wire can be seen inside the spring. Press the spring down until it audibly snaps into place.

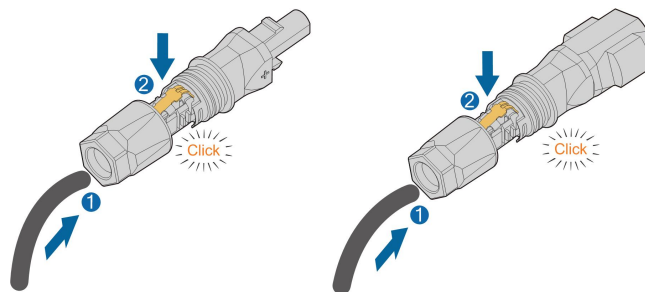

**step 4** Push the insert into the sleeve and tighten the cable gland (torque 2 N · m).



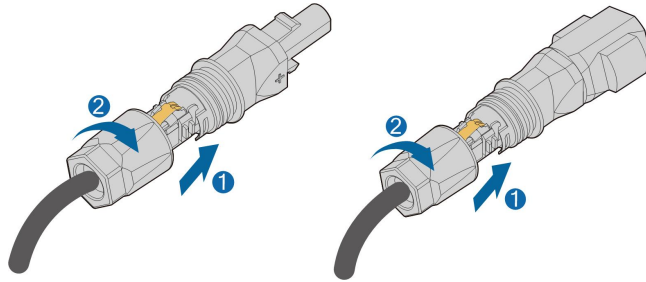

-- End

### 6.9.1.2 Installing the SUNCLIX Connector

#### NOTICE

Only connect these connectors with other SUNCLIX connectors. When making the connections, always observe the specifications regarding nominal voltage and nominal current. The smallest common value is permissible.

**step 1** Plug the connectors into **BAT+** and **BAT-** terminals.

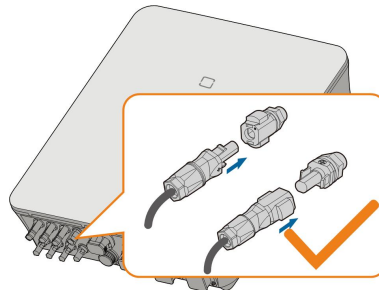

**step 2** Ensure that the connectors are securely in place.

-- End

### 6.9.2 Connecting the CAN Cable

The CAN cable enables the communication between the inverter and the Li-ion battery from SUNGROW, BYD and Pylontech.

#### Procedure

For detailed connection description of the CAN cable, refer to the section "[6.7.3 RS485 Connection](#)". Plug the wires into the **BMS/CAN** terminal according the labels on the bottom of the inverter.

### 6.9.3 Connecting the Enable Cable

The Enable cable along with the RS485 cable, are used for communication between the inverter and the Li-ion battery from LG Chem.

### Procedure

For detailed connection description of the RS485 cable, refer to the section "[6.7.3 RS485 Connection](#)".

For detailed connection description of the Enable cable, refer to the section "[6.7.3 RS485 Connection](#)". Plug the wires into the **Enable** terminal according the labels on the bottom of the inverter.

## 6.10 DO Connection

The inverter has one DO relay with multiple functions as follows:

- Consumer load control. In this case the DO relay will control a contactor that will open or close in certain condition. Please choose the appropriate contactor according to the load power, e.g. the contactor types of the 3TF30 series from SIEMENS (3TF30 01-0X).
- Earth fault alarm. In this case, the additional equipment required is a light indicator and/or a buzzer.

Relay	Trigger condition	Description
Consumer load control	The load control mode has been set via the iSolarCloud App.	The relay is activated once the conditions of the control mode are satisfied. See " <a href="#">8.10.9 Load Control</a> ".
Earth fault alarm	The earth fault occurs.	Once the inverter receives the earth fault signal, the relay closes the contact. The relay remains triggered until the fault is removed. See " <a href="#">8.10.12 Grounding Detection</a> ".

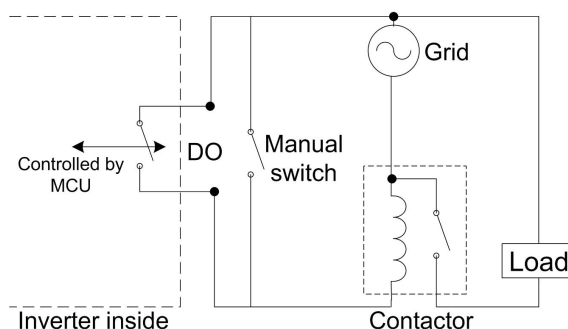

**NOTICE**

- An AC contactor must be installed between the inverter and appliances. It is forbidden to connect the load directly to the DO port.
- The current of the DO dry contact should not be larger than 3 A.
- The DO node is not controlled once the inverter is powered off. Connect the AC contactor by the manual switch, so as to control the loads.

**Procedure**

For detailed connection description of the DO cable, refer to the section "[6.7.3 RS485 Connection](#)". Plug the wires into the DO terminal according the labels on the bottom of the inverter.

## 6.11 DI Connection

DRM and Ripple Control support only one function at the same time.

**DRM**

The inverter supports the demand response modes as specified in the standard AS/NZS 4777. The inverter has integrated a terminal block for connecting to a DRED.

After the connection, the DRED assert DRMs by shorting together terminals as specified in the table below.

table 6-4 Method of Asserting DRMs

Mode	Asserted by Shorting Terminals
DRM0	R & C
DRM1	D1/5 & C
DRM2	D2/6 & C
DRM3	D3/7 & C
DRM4	D4/8 & C
DRM5	D1/5 & R
DRM6	D2/6 & R
DRM7	D3/7 & R
DRM8	D4/8 & R

The modes from DRM0 to DRM8 are supported by the inverter and the information is marked on the label located in the top of COM terminal.

Wiring between the inverter and the DRED is as follows.

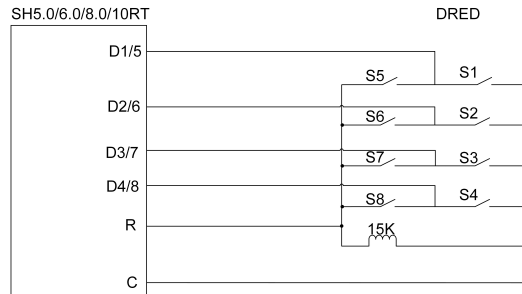

The switches that need to be closed in the state of DRM0 ~ DRM8 are shown in the table below.

Demand Response Mode	Operational Instruction	Switch state
DRM0	OI0	Close S1 and S5
DRM1	OI1	Close S1
DRM2	OI2	Close S2
DRM3	OI3	Close S3
DRM4	OI4	Close S4
DRM5	OI5	Close S5
DRM6	OI6	Close S6
DRM7	OI7	Close S7
DRM8	OI8	Close S8

### Ripple Control

In Germany, the grid company uses the Ripple Control Receiver to convert the grid dispatching signal and send it as a dry contact signal.

Wiring of the ripple control receiver dry contact cables is shown in the figure below:

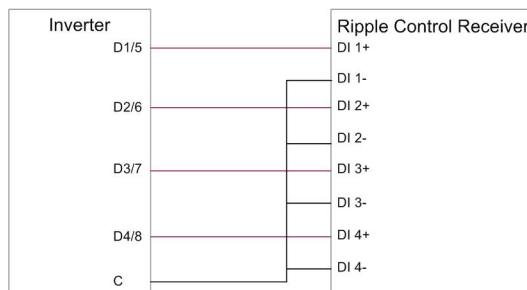

#### 6.11.1 Assembling the COM Connector

**step 1** Unscrew the swivel nut from the connector.

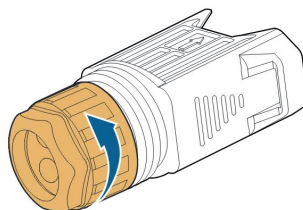

**step 2** Take out the terminal block.

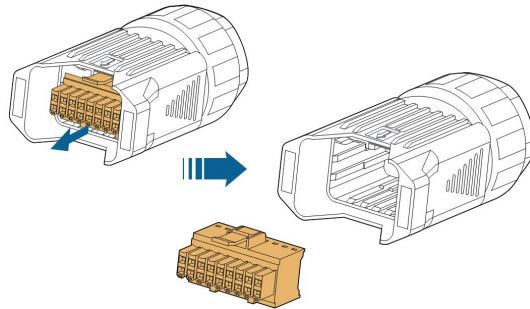

**step 3** Remove the seal and lead the cable through the cable gland.

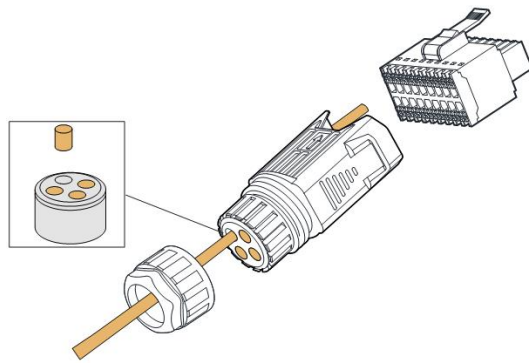

**step 4** Remove the cable jacket by 7 mm – 10 mm.

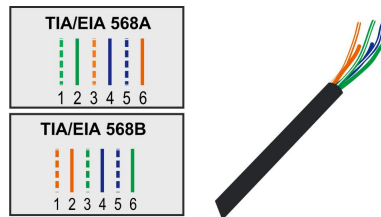

**step 5** Plug the wires into the corresponding terminal according the labels on the bottom of the inverter.

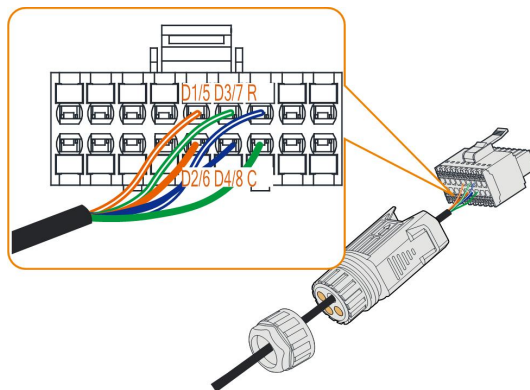

**step 6** Pull the wires outward to check whether they are firmly installed.

**step 7** Insert the terminal block into the connector until it snaps into place with an audible click.

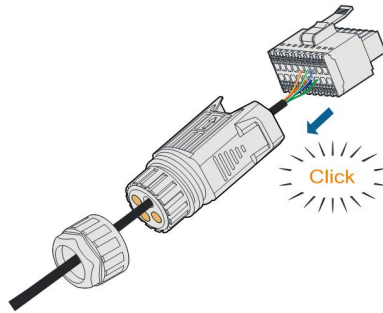

**step 8** Fasten the swivel nut.

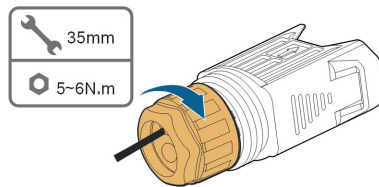

-- End

### 6.11.2 Installing the COM Connector

**step 1** Remove the waterproof lid from the **COM** terminal.

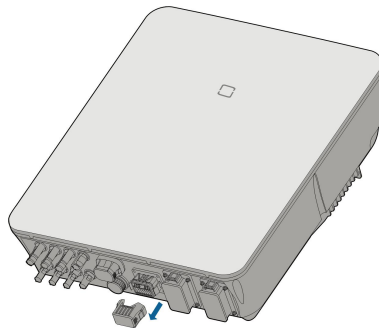

**step 2** Insert the COM connector into **COM** terminal on the bottom of the inverter until there is an audible click.

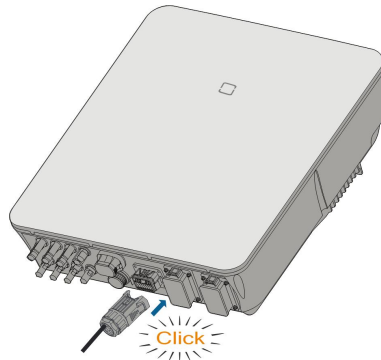

**step 3** Pull cables outwards to confirm whether they are fastened firmly.

**step 4** Connect the other end to the DRED / Ripple Control Receiver device.

-- End

## 6.12 Backup Connection

**step 1** Assembling the BACK-UP Connector. Specifically, refer to "[6.5.2 Assembling the AC Connector](#)".



The PE wire of Backup terminal is not required for Australia and New Zealand.

**step 2** Remove the waterproof lid from the **BACK-UP** terminal.

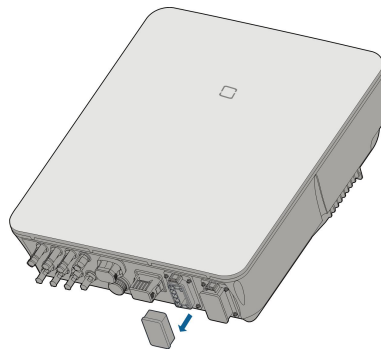

**step 3** Align the Backup connector and the **BACK-UP** terminal and mate them together by hand until a "Click" is heard or felt.

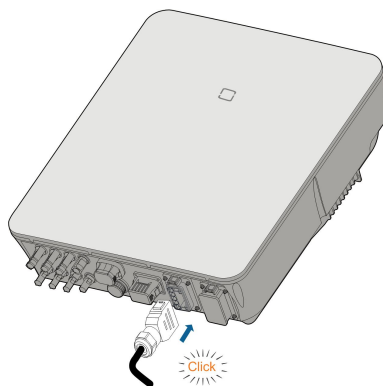

**step 4** Pull all the lines outward to check whether they are firmly installed.

-- End



# 7 Commissioning

## 7.1 Inspection before Commissioning

Check the following items before starting the inverter:

- All the installation sites are convenient for operation, maintenance and service.
- All devices are firmly installed.
- Space for ventilation is sufficient for one inverter or multiple inverters.
- Nothing is left on the top of the inverter.
- The inverter and accessories are correctly connected.
- Cables are routed safely and protected against mechanical damage.
- The selection of the AC circuit breaker is in accordance with this manual and all applicable local standards.
- All unused terminals at the bottom of the inverter are properly sealed.
- Warning signs & labels are intact and legible.

## 7.2 Commissioning Procedure

If all of the items mentioned above meet the requirements, proceed as follows to start up the inverter for the first time.

**step 1** Connect the AC circuit breaker.

**step 2 (Optional)** Connect the external DC circuit breaker between the inverter and the battery pack if a battery is equipped.

**step 3 (Optional)** Power on the battery pack manually if a battery is equipped.

**step 4** Rotate the DC switch to “ON”. The DC switch may be integrated in the inverter or installed by the customer, wait for at least 5 minutes.

**step 5** If the irradiation and grid conditions meet requirements, the inverter will normally operate. The connection time for inverter to grid may take some minutes or even to more according to different country code chosen in the initial settings and the real site grid condition.

**step 6** Observe the LED indicator to ensure that the inverter operates normally. (Refer to ["2.4 LED Indicator"](#)).

-- End

## 7.3 App Preparation

- step 1** Install the iSolarCloud App with latest version. Refer to "[8.2 Installing the App](#)".
- step 2** Register an account. Refer to "[8.3 Account Registration](#)". If you have got the account and password from the distributor/installer or SUNGROW, skip this step.
- step 3** Download the firmware package to the mobile device in advance. Refer to "[8.10.11 Firmware Update](#)". This is to avoid download failure due to poor on-site network signal.
- End

## 7.4 Creating a Plant

Screenshots of creating a plant are for reference only. For details, refer to the actual screen.

- step 1** Open the App, tap  at the upper right corner and tap **Select Server**. Choose the same server as when registering.

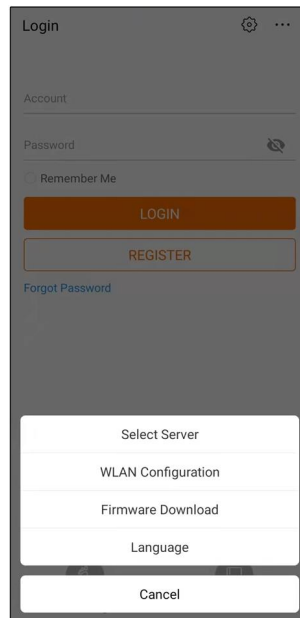

**figure 7-1** Selecting the Server

- step 2** Enter the account and password on the login screen and tap **Login** to enter the App home screen.
- step 3** Tap the icon  at the upper right corner to enter the creating screen.

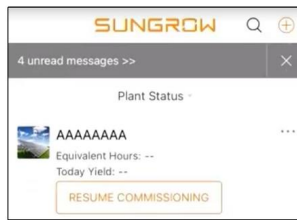

figure 7-2 Creating Power Plant

**step 4** Select plant type to **RESIDENTIAL** and inverter type to **HYBRID**.

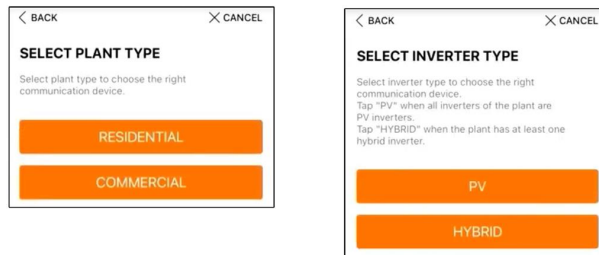

figure 7-3 Selecting Plant/Inverter Type

**step 5** Scan the QR code on the communication device or manually enter the serial number of the communication device. Tap **Next** after the QR code is identified or the serial number entered is correct and then tap **CONFIRM**. Your mobile device is thus connected to the WiNet-S successfully.

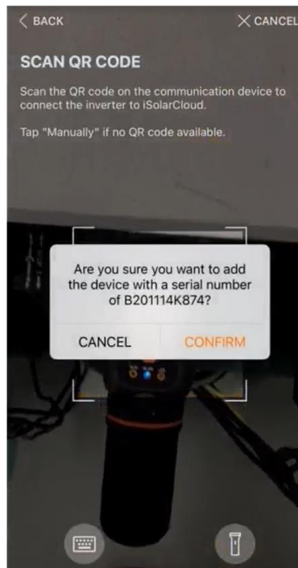

figure 7-4 Connecting Mobile Device to WiNet-S

**step 6** Select the Internet access mode to **WLAN(CONNECTED)** or **ETHERNET** according to actual connection. The following description is for WLAN access mode.

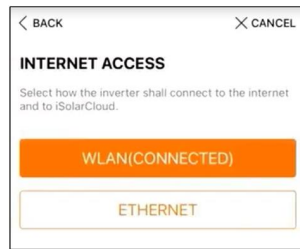

figure 7-5 Selecting Internet Access Mode

**step 7** The **EASYCONNECT INSTRUCTION** screen will prompt. Press the multi-function button on the WiNet-S module once to turn on EasyConnect mode. The WLAN indicator on WiNet-S blinks quickly when this mode is turned on. Return to the App and the screen displays successful connection to the inverter WLAN. Tap **NEXT**.

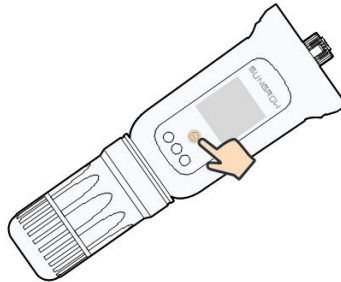

figure 7-6 Turn on EasyConnect Mode

#### NOTICE

The EasyConnect mode can be used only when the router is 2.4 GHz.  
If the EasyConnect mode fails, refer to the WiNet-S quick guide for the instructions of other modes.

**step 8** Connect the inverter to router network. Enter network name and password. Tap **NEXT** and the screen display prompt information of successful connection to the router network.

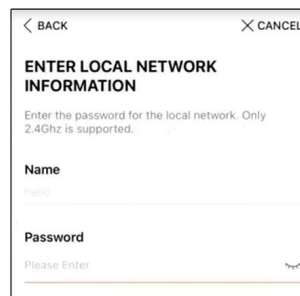

figure 7-7 Connecting Inverter to Router Network

-- End

## 7.5 Initializing the Device

The inverter is successfully connected to the router.

If there is no latest equipment upgrade package, skip steps 1 and 2.

The actual initializing procedure may differ due to different countries. Please follow the actual App guidance.

**step 1** If a latest equipment upgrade package is available, the following prompt window pops up. Tap **UPDATE NOW** to download the latest update package.

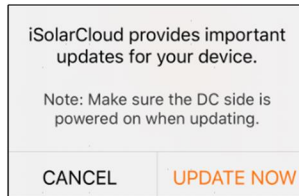

figure 7-8 Upgrade Reminder

**step 2** After download, it would take around 15 minutes to update. After successful upgrade, the screen will show the version numbers before and after the upgrade as well as the upgrade time. Tap **NEXT**.

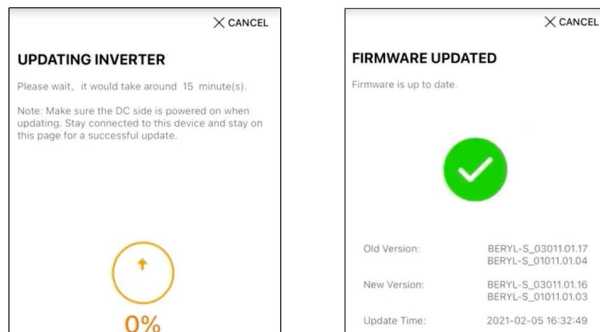

figure 7-9 Upgrading Inverter

### NOTICE

If the communication equipment is upgraded, after successful upgrade, check and confirm that the phone is connected to the inverter WLAN.

**step 3** Tap **Country/Region** and select the country where the inverter is installed at.

### NOTICE

The parameter **Country/Region** must be set to the country (region) where the inverter is installed at. Otherwise, the inverter may report errors.

**step 4** When the country is set to Australia, additionally set the applicable network service provider and then the grid type.

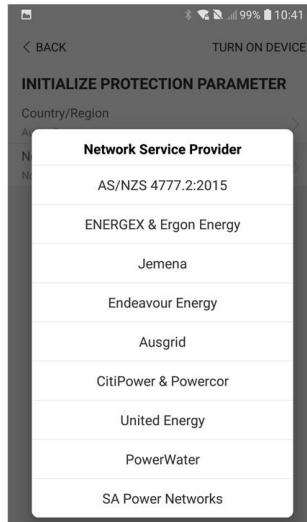

The image shown here is for reference only. Refer to the actual interface for the supported network service providers.

**step 5** Initialize parameters according to local grid requirements, including grid type, reactive power regulation mode, etc. The screen displays that the inverter is successfully configured.

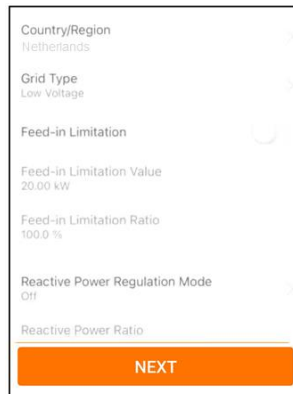

**figure 7-10** Initializing Parameters

-- End

## 7.6 Configuring the Plant

The inverter is successfully added to the plant and initialized. Refer to the guidance in previous sections.

The distributor/installer who creates a plant for the end user needs to get the end user's e-mail address. In configuring a plant, the e-mail address is required, and each e-mail address can be registered only once.

**step 1** The App screen will display the added inverter. Tap **NEXT** to configure the plant.

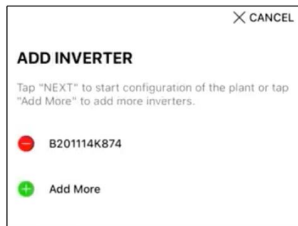

**figure 7-11** Display the Added Inverter

**step 2** Fill in the plant information. The fields marked with \* must be filled in.

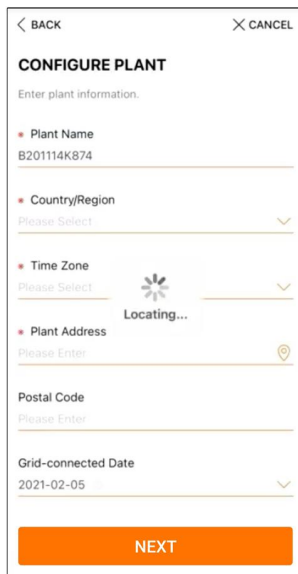

**figure 7-12** Entering Plant Information

**step 3 (Optional)** Fill in the tariff information. The electricity price can be set to a specific value or Time-of-Use tariff.

figure 7-13 Entering Tariff Information

**step 4** Fill in the end user's e-mail address. The first time you fill in the end user's e-mail address, the system will create an account for the end user and send an email to the end user. The end user can activate the account via the email.



The Distributor/installer creates plants for the end user and can manage the plants by default.

figure 7-14 Entering Owener's e-mail

**step 5** Tap **NEXT** to wait for the inverter to connect to the iSolarCloud.



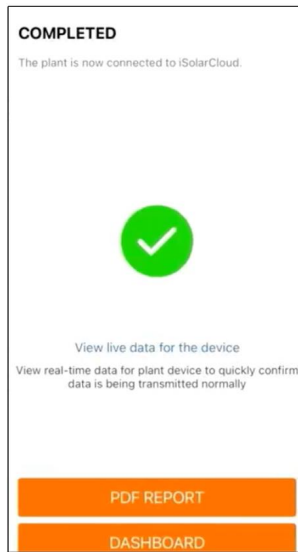

figure 7-15 Configuration Completed

**step 6 (Optional)** Tab **View live data for the device**, tick **Inverter** or **Total Plant Devices** and tab **ALL PLANTS OPEN**. The clock symbol indicates that the live data view function is successfully enabled. Tab the inverter to view the live data about voltage, current, power or curve.

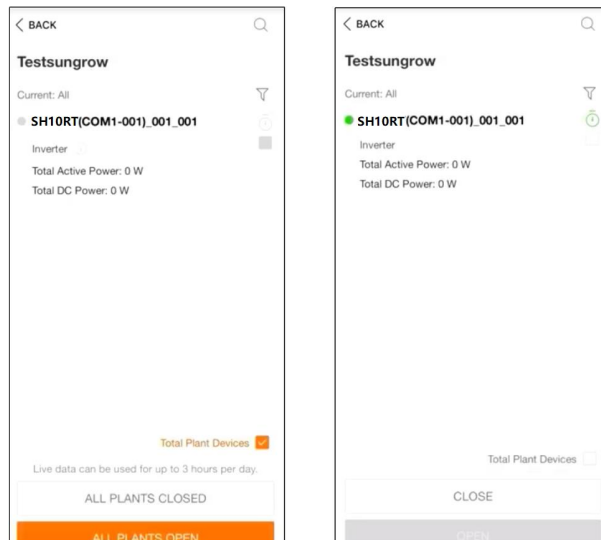

figure 7-16 Live Data View Function Setting



Consult Sungrow service for the devices that support live data function.

**step 7** Tab **BACK** to the **COMPLETED** screen. Tab **PDF REPORT** to export the plant configuration report.

**step 8** Tab **BACK** to the **COMPLETED** screen. Tab **DASHBOARD** to return and manually refresh the page until the newly created plant is displayed with status commissioned.

-- **End**

# 8 iSolarCloud App

## 8.1 Brief Introduction

The iSolarCloud App can establish communication connection to the inverter via the WLAN, providing remote monitoring, data logging and near-end maintenance on the inverter. Users can also view inverter information and set parameters through the App.

\* To achieve direct login via WLAN, the wireless communication module developed and manufactured by SUNGROW is required. The iSolarCloud App can also establish communication connection to the inverter via Ethernet connection.



- This manual describes only how to achieve near-end maintenance via WLAN direct connection.
- Screenshots in this manual are based on the V2.1.6 App for Android system, and the actual interfaces may differ.

## 8.2 Installing the App

### Method 1

Download and install the App through the following application stores:

- MyApp (Android, mainland China users)
- Google Play (Android, users other than mainland China ones)
- App Store (iOS)

### Method 2

Scan the following QR code to download and install the App according to the prompt information.



The App icon appears on the home screen after installation.



### 8.3 Account Registration

The account distinguishes two user groups, end user and distributor/installer.

- The end user can view plant information, create plants, set parameters, share plants, etc.
- The distributor/installer can help the end user to create plants, manage, install, or maintain plants, and manage users and organizations.

**step 1** Tap **REGISTER** to enter the registration screen.

**step 2** Select **End user** or **Distributor/Installer** to enter the corresponding screen.

**figure 8-1** Selecting User Group

**step 3** Fill in the registration information, including server selection, email, verification code, password and affirmance, country (region) and time zone. The distributor/installer has the permission to fill in the company name and the code of upper level distributor/installer.



The code of upper level distributor/installer can be obtained from the upper level distributor/installer. Only when your organization belongs to the upper level distributor/installer organization, can you fill in the corresponding code.

**step 4** Tick **Accept privacy protocol** and tap **Register** to finish the registration operation.

-- End

## 8.4 Login

### 8.4.1 Requirements

The following requirements should be met:

- The AC and DC sides or the AC side of the inverter is powered-on.
- The WLAN function of the mobile phone is enabled.
- The mobile phone is within the coverage of the wireless network produced by the communication module.

### 8.4.2 Login Procedure

**step 1** For the WiNet-S module, press the multi-function button 3 times to enable the WLAN hotspot. No password is required and the valid time is 30 minutes.

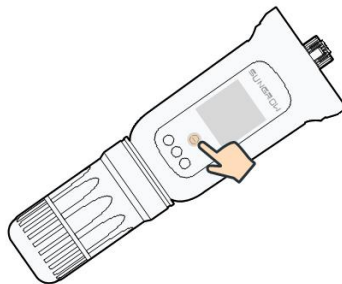

**figure 8-2** Enabling the WLAN Hotspot

**step 2** Connect the mobile phone to the WLAN network named as "SG-xxxxxxxxxx" (xxxxxxxxxx is the serial number indicated on the side of the communication module).

**step 3** Open the App to enter the login screen. Tap **Local Access** to enter the next screen.

**step 4** Select **WLAN** and select the device (SN), then enter the password and tap **LOGIN**.



The default account is "user" and the initial password is "pw1111" which should be changed for the consideration of account security. Tap "More" at the lower right corner on home page and choose "Change Password".

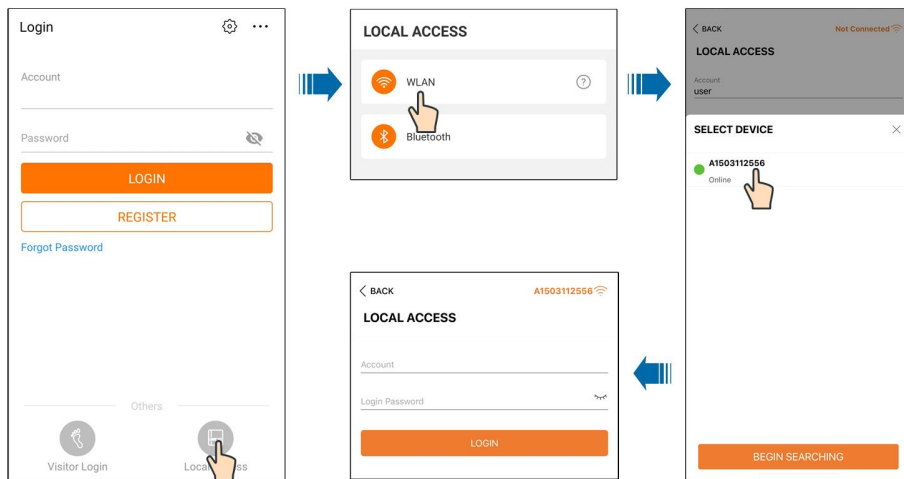

figure 8-3 WLAN Local Access

**step 5** If the inverter is not initialized, navigate to the quick setting screen to initialize the protection parameters. For details, please refer to "**Initial Settings**".

#### NOTICE

The "Country/Region" must be set to the country where the inverter is installed at. Otherwise, the inverter may report errors.

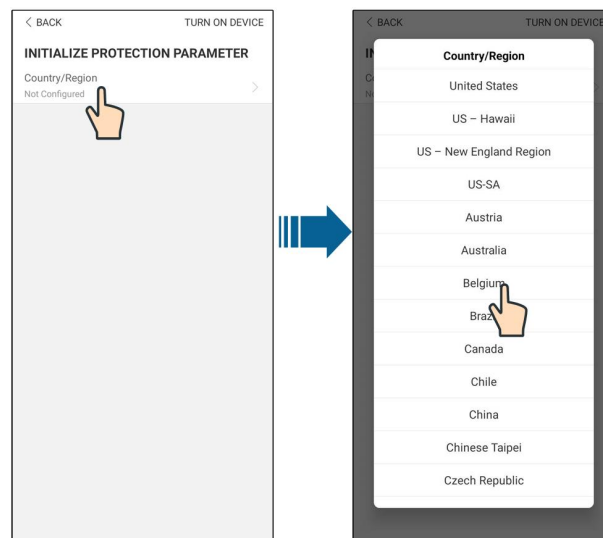

figure 8-4 WLAN Local Access

**step 6** After finishing the settings, tap **TURN ON DEVICE** at the upper right corner and the device will be initialized. The App will send start instructions and the device will start and operate.

**step 7** After initialization settings, the App will return automatically to the home page.

-- End

## 8.5 Initial Settings

### 8.5.1 Feed-in Limitation

The function of the feed-in limitation is to control the amount of power injected in the grid by the plant. In some situations, this function is also called as **Export limitation** or **Zero export**. The feed-in limitation function requires the using of Smart Energy Meter. Without the Smart Energy Meter, the feed-in limitation function will be unavailable.

table 8-1 Description of feed-in limitation parameters

Parameter	Default value		Range	
	Germany	Others	Germany	Others
PV Installation Power	Rated power	-	Rated power ~ 300.00	-
Feed-in Limitation	On	Off	On / Off	
Feed-in Limitation Value	PV Installation Power × 70% *	Rated power	0 ~ PV Installation Power	0 ~ Rated power
Feed-in Limitation Ratio	70.0%*	100.0%	0 ~ 100%	
Rated Power of Original Power Generation Systems	Depends on inverter power of other companies			

\*If power control is regulated by a third party logger, please enable the power limitation to 100% in default.

### 8.5.2 Off-grid Mode

The off-grid mode is off by default, the user can set an amount of **Reserved Battery SOC for Off-Grid**. It is the minimum battery level in the on-grid state and will be supplied to the Backup loads in case of grid blackout.

### 8.5.3 Reactive Power Regulation Mode

The inverter provides a reactive power regulation function. Use the **Reactive Power Regulation Mode** parameter to activate this function and select proper regulation mode.

**table 8-2** Descriptions of reactive power regulation mode:

Mode	Descriptions
Off	The PF is fixed at +1.000.
PF	The reactive power can be regulated by the parameter PF (Power Factor).
Qt	The reactive power can be regulated by the parameter Q-Var limits (in %).
Q(P)	The PF changes with the output power of the inverter.
Q(U)	The reactive power changes with the grid voltage.

**“ Off ” Mode**

The reactive power regulation function is disabled. The PF is limited to +1.000.

**“ PF ” Mode**

The power factor is fixed and reactive power setpoint is calculated according to the current power. The PF ranges from 0.8 leading to 0.8 lagging.

Leading: the inverter is sourcing reactive power to the grid.

Lagging: the inverter is injecting reactive power into the grid.

**“ Qt ” Mode**

In the Qt mode, system rated reactive power is fixed, and the system injects reactive power according to the delivered reactive power ratio. The **Reactive Power Ratio** is set through the App.

The setting range of the reactive power ratio is 0~100% or 0~-100%, corresponding to the ranges of inductive and capacitive reactive power regulation respectively.

**“ Q(P) ” Mode**

The PF of the inverter output varies in response to the output power of the inverter.

**table 8-3** “ Q(P) ” Mode Parameter Descriptions:

Parameter	Explanation	Default		Range
		DE	AU	
<b>Q(P) Curve</b>	Select corresponding curve according to local regulations	A		A, B, C*
<b>QP_P1</b>	Output power at P1 on the Q(P) mode curve (in percentage)	20%	25%	10% ~ 100%
<b>QP_P2</b>	Output power at P2 on the Q(P) mode curve (in percentage)	50%		20% ~ 100%
<b>QP_P3</b>	Output power at P3 on the Q(P) mode curve (in percentage)	100%		20% ~ 100%



Parameter	Explanation	Default		Range
		DE	AU	
QP_K1	Power factor at P1 on the Q(P) mode curve	1		Curve A/C: 0.8 ~ 1
QP_K2	Power factor at P2 on the Q(P) mode curve	1		
QP_K3	Power factor at P3 on the Q(P) mode curve	0.95	0.90	Curve B: - 0.6 ~ 0.6
QP_EnterVoltage	Voltage percentage for Q(P) function activation	105%		100% ~ 110%
QP_ExitVoltage	Voltage percentage for Q(P) function deactivation	100%		90% ~ 100%
QP_ExitPower	Power percentage for Q(P) function deactivation	20%		1% ~ 20%
QP_EnableMode	Unconditional activation/deactivation of Q(P) function	Yes		Yes / No

\* Curve C is reserved and consistent with Curve A currently.

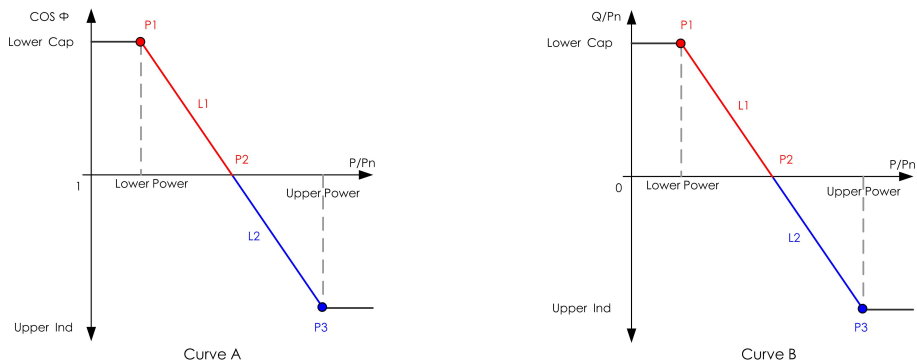

figure 8-5 Q(P) Curve

### “Q(U)” Mode

The reactive power output of the inverter will vary in response to the grid voltage.

table 8-4 “Q(U)” Mode Parameter Descriptions:

Parameter	Explanation	Default		Range
		DE	AU	
Q(U) curve	Select corresponding curve according to local regulations	A		A, B, C*
Hysteresis Ratio	Voltage hysteresis ratio on the Q(U) mode curve	0		0 ~ 5%
QU_V1	Grid voltage limit at P1 on the Q(U) mode curve	93%	90%	80% ~ 100%
QU_Q1	Value of Q/Sn at P1 on the Q(U) mode curve	-60%	-30%	-60% ~ 0

Parameter	Explanation	Default		Range
		DE	AU	
QU_V2	Grid voltage limit at P2 on the Q(U) mode curve	97%	95.6%	80% ~ 110%
QU_Q2	Value of Q/Sn at P2 on the Q(U) mode curve		0	-60% ~ 60%
QU_V3	Grid voltage limit at P3 on the Q(U) mode curve	103- %	AU: 108.7% NZ: 108.6%	100% ~ 120%
QU_Q3	Value of Q/Sn at P3 on the Q(U) mode curve		0	-60% ~ 60%
QU_V4	Grid voltage limit at P4 on the Q(U) mode curve	107- %	AU: 115.2% NZ: 110.8%	100% ~ 120%
QU_Q4	Value of Q/Sn at P4 on the Q(U) mode curve	60%	30%	0 ~ 60%
QU_EnterPower	Active power for Q(U) function activation		80%	20% ~ 100%
QU_ExitPower	Active power for Q(U) function deactivation		10%	1% ~ 20%
QU_EnableMode	Unconditional activation/deactivation of Q(U) function		Yes	Yes / No / Yes, Limited by PF

\* Curve C is reserved and consistent with Curve A currently.

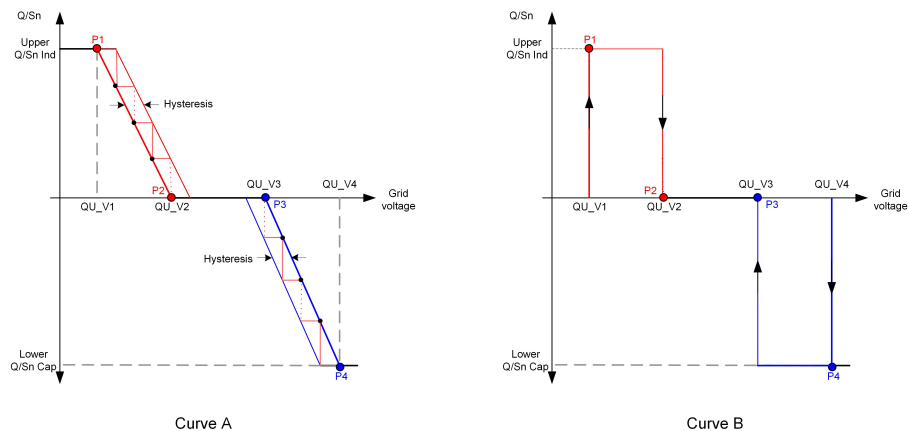

figure 8-6 Q(U) Curve

## 8.6 Function Overview

The App provides parameter viewing and setting functions, as shown in the following figure.

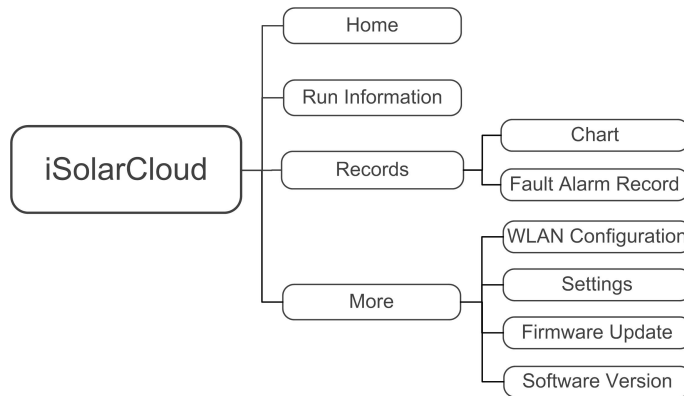

figure 8-7 App Function Tree Map

## 8.7 Home

Home page of the App is shown in the following figure.

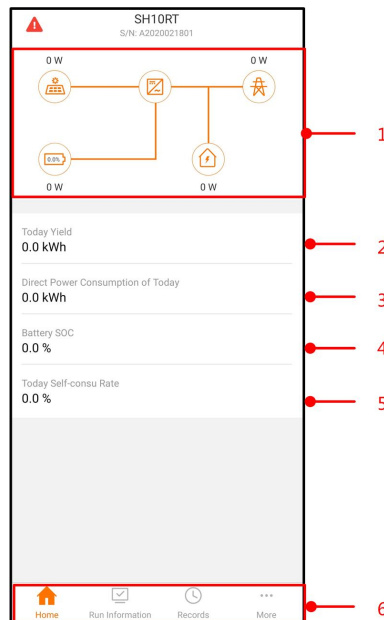



figure 8-8 Home

table 8-5 Home page description

No.	Name	Description
1	Load flow chart	Shows the PV power generation power, feed-in power, etc. The line with an arrow indicates energy flow between connected devices, and the arrow pointing indicates energy flow direction.
2	Today yield	Shows today power generation of the inverter

No.	Name	Description
3	<b>Direct Power Consumption of Today</b>	Shows electricity directly consumed by loads today
4	<b>Battery SOC</b>	Indicates remaining battery capacity
5	<b>Today Self-consumption Rate</b>	Indicates today self-consumption rate of the PV system
6	Navigation bar	Includes menus of <b>Home</b> , <b>Run Information</b> , <b>Records</b> , and <b>More</b> .

If the inverter runs abnormally, the fault icon  appears on the upper left corner of the screen. Users can tap the icon to view detailed fault information and corrective measures.

## 8.8 Run Information

Tap **Run Information** on the navigation bar to enter the corresponding screen, as shown in the following figure.

RUN INFORMATION	
PV Information ^	
String 1 Voltage	0.0 V
String 1 Current	0.00 A
String 2 Voltage	0.0 V
String 2 Current	0.00 A
Daily PV Yield	0.0 kWh
Total PV Yield	0.0 kWh
Inverter Information ^	
Running Status	Shut Down
Bus Voltage	0.0 V
Internal Air Temperature	24.9 °C
Array Insulation Resistance	0 kΩ
Country (Region) Information	Germany
Ripple Control state	No RIPP Schedule
Power Limitation Mode	Unlimited Power

figure 8-9 Run Information

The run information includes the PV information, inverter information, input, output, grid information, load information, and battery information.

## 8.9 Records

Tap **Records** on the navigation bar to enter the screen, as shown in the following figure.



figure 8-10 Records

On **Records** screen, users can view chart and check fault alarm record.

### 8.9.1 Chart

Tap **Chart** to enter the screen showing daily power generation, as shown in the following figure.

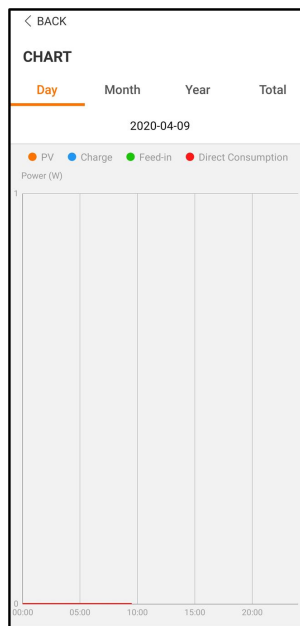

figure 8-11 Power Curve

The App displays power generation records in a variety of forms, including daily power generation graph, monthly power generation histogram, annual power generation histogram, and total power generation histogram.

table 8-6 Description of power generation records

Item	Description
Daily power generation graph	Indicates today power generation, charging, feed-in power, and direct consumption power
Monthly power generation histogram	Indicates monthly power generation, charging, feed-in power, and direct consumption power

Item	Description
Annual power generation histogram	Indicates annual power generation, charging, feed-in power, and direct consumption power
Total power generation histogram	Indicates total power generation, charging, feed-in power, and direct consumption power

## 8.9.2 Fault Alarm Record

Tap **Fault Alarm Record** to enter the screen, as shown in the following figure.

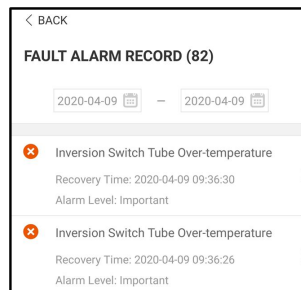

figure 8-12 Fault Alarm Record



Click "📅" to select a time segment and view corresponding records.

Select one of the records in the list and click the record, to view the detailed fault info as shown in following figure.

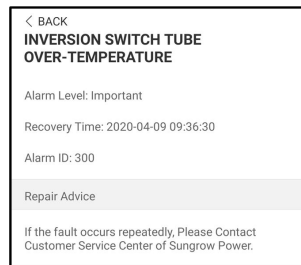

figure 8-13 Detailed fault alarm info

## 8.10 More

Tap **More** on the navigation bar to enter the screen, as shown in the following figure.

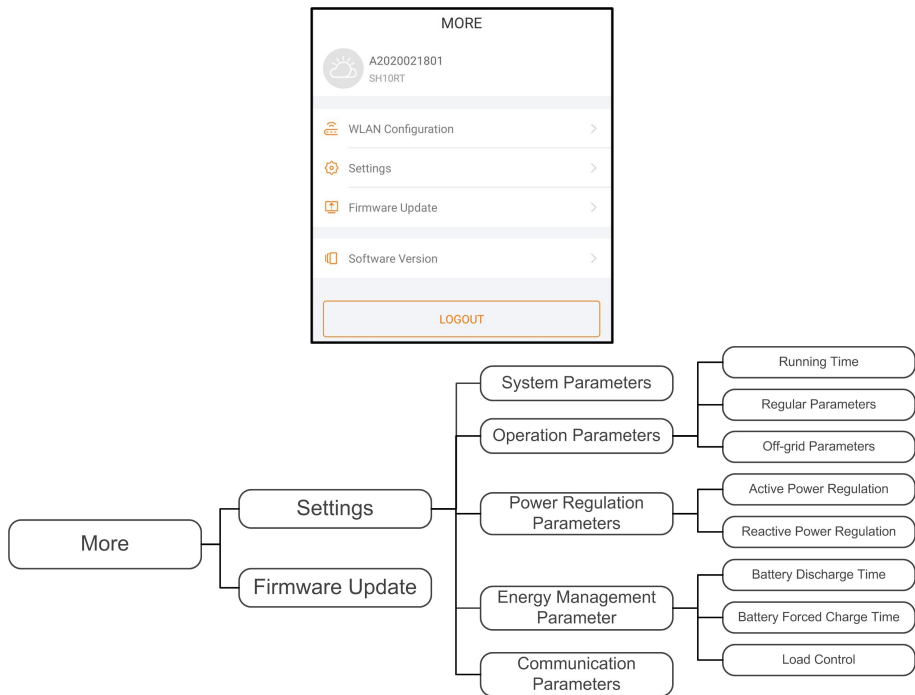

figure 8-14 More

The **More** screen supports the following operations:

- Set parameters including inverter system parameters and energy management parameter.
- Upgrade inverter firmware (ARM/DSP/PVD/CPLD).

### 8.10.1 System Parameters

Tap **Settings**→**System Parameters** to enter the corresponding screen, as shown in the following figure.

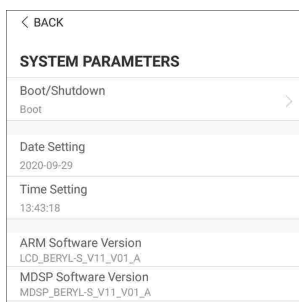

figure 8-15 System Parameters

#### Boot/Shutdown

Tap **Boot/Shutdown** to send the boot/shutdown instruction to the inverter.

For Australia and New Zealand, when the DRM state is DRM0, the "Boot" option will be prohibited.

## Date/Time

The correct system time is very important. Wrong system time will directly affect the data logging and power generation value. The clock is in 24-hour format.

### 8.10.2 Running Time

Tap **Settings**→**Operation Parameters**→**Running Time** to enter the corresponding screen, on which you can set **Connecting Time** and **Reconnecting Time**.

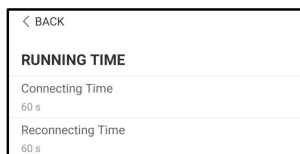

figure 8-16 Running Time

table 8-7 Description of running time parameters

Parameter	Explanation	Default	Range
Connecting Time	The time that the inverter takes to enter into the running mode from the standby mode in fault-free state	60s	20s ~ 900s
Reconnecting Time	The time that the inverter takes to recover from the fault state to normal state (the inverter is not running)	60s	0s ~ 3600s

### 8.10.3 Regular Parameters

Tap **Settings**→**Operation Parameters**→**Regular Parameters** to enter the screen, as shown in the following figure.

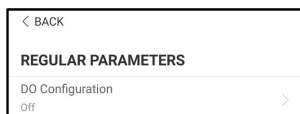

figure 8-17 Regular Parameters

After connecting the load to the DO terminals, a relay control signal will be transmitted. Users can flexibly set the control mode of DO configuration according to individual demand.

table 8-8 The control mode of DO configuration

Mode	Setting description
Off	-
Load Control Mode	See "8.10.9 Load Control"
Grounding Detection	See "8.10.12 Grounding Detection"



### 8.10.4 Off-grid Parameters

Tap **Settings**→**Operation Parameters**→**Off-grid Parameters** to enter the screen, as shown in the following figure.

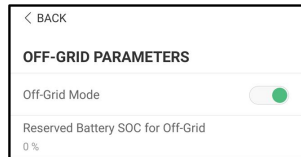

figure 8-18 Off-grid Parameters

Refer to the description in "[8.5.2 Off-grid Mode](#)".

### 8.10.5 Active Power Regulation

Tap **Settings**→**Power Regulation Parameters**→**Active Power Regulation** to enter the screen, as shown in the following figure.

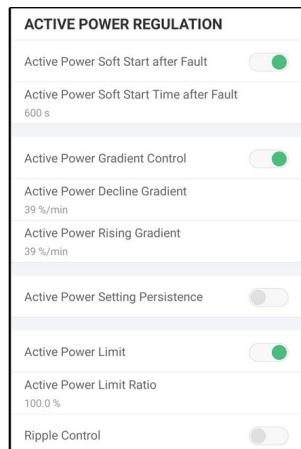

figure 8-19 Active Power Regulation

table 8-9 Description of active power regulation

Parameter	Description	Default	Range
<b>Active Power Soft Start after Fault</b>	Switch for activating/deactivating the function of active power soft start after a fault occurs	On	On/Off
<b>Active Power Soft Start Time after Fault</b>	The soft start time required for raising active power from 0 to rated value after a fault occurs	600s	1s ~ 1200s
<b>Active Power Gradient Control</b>	Set whether to enable active power gradient control	On	On/Off
<b>Active Power Decline Gradient</b>	Decline gradient of inverter active power per minute	39%/min	3%/min ~ 6000%/min

Parameter	Description	Default	Range
Active Power Rising Gradient	Rising gradient of inverter active power per minute		
Active Power Setting Persistence	Switch for activating/deactivating the function of active power setting persistence	Off	On/Off
Active Power Limit	Switch for limiting active power	On	On/Off
Active Power Limit Ratio	The ratio of active power limit to rated power in percentage	100.0%	0 ~ 110%
Ripple Control	Switch for Ripple Control	Off	On/Off

### 8.10.6 Reactive Power Regulation

Tap **Settings**→**Power Regulation Parameters**→**Reactive Power Regulation** to enter the screen, as shown in the following figure.

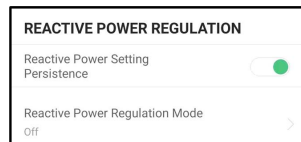

figure 8-20 Reactive Power Regulation

table 8-10 Description of reactive power regulation

Parameter	Description	Default	Range
Reactive Power Setting Persistence	Switch for activating/deactivating the function of reactive power setting persistence	On	On / Off
Reactive Power Regulation Mode	See " <a href="#">8.5.3 Reactive Power Regulation Mode</a> "	Off	Off / PF / Qt / Q(P) / Q(U)

### 8.10.7 Battery Discharge Time

Tap **Settings**→**Energy Management Parameter**→**Battery Discharge Time** to enter the corresponding screen, as shown in the following figure.

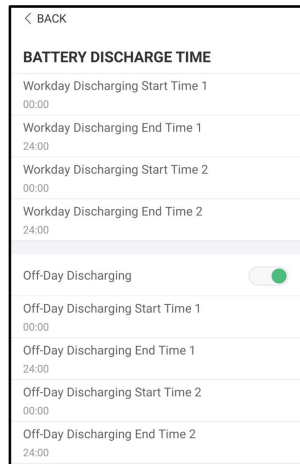

figure 8-21 Battery Discharge Time

### 8.10.8 Battery Forced Charge Time

Tap **Settings**→**Energy Management Parameter**→**Battery Forced Charge Time** to enter the corresponding screen.

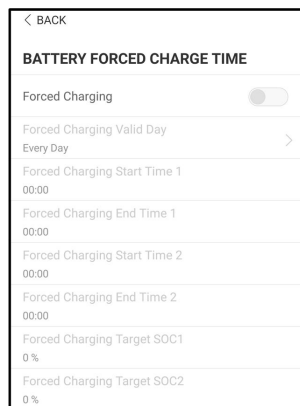

figure 8-22 Battery Forced Charge Time

When there is no PV power, the power imported from the grid charges the energy system during the time period until the target SOC is reached.

It is recommended to set the time period in off-peak tariff time. The time period 1 is in priority to the time period 2 if two periods overlap. The charging energy comes from the excess PV energy in priority and then from the grid. The inverter will take charging power from the grid in the case of PV energy shortage.

### 8.10.9 Load Control

Tap **Settings**→**Energy Management Parameter**→**Load Control** to enter the corresponding screen, on which you can set **Load Control Mode**. Load Control Mode includes **Timing Mode**, **Switch Mode**, and **Intelligent Mode**.

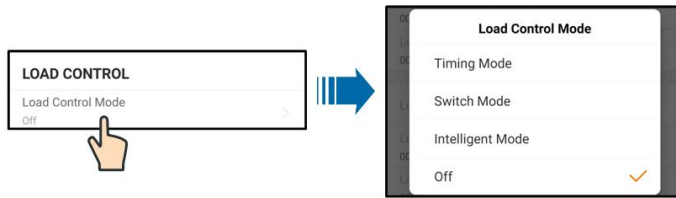

figure 8-23 Load Control

**Timing Mode**

In this mode, set the **Load Timing Start Time 1** and **Load Timing End Time 1**, the system will control the load operation during the interval. Take 09:00 am – 09:30 am as an example.

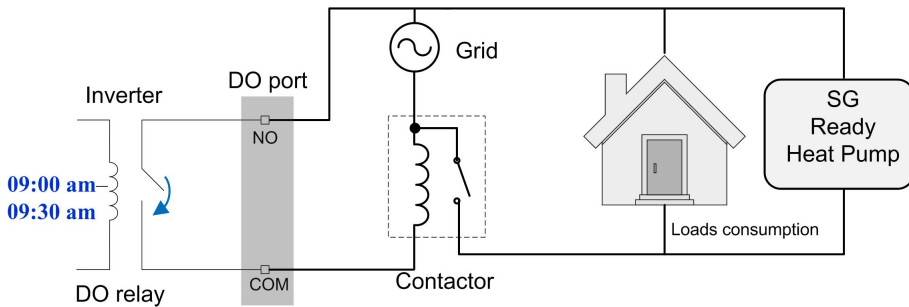

figure 8-24 DO Operation in Timing Mode

**Switch Mode**

In this mode, the system will control the load operation according to the setting. In the following example, the switch is set to OFF.

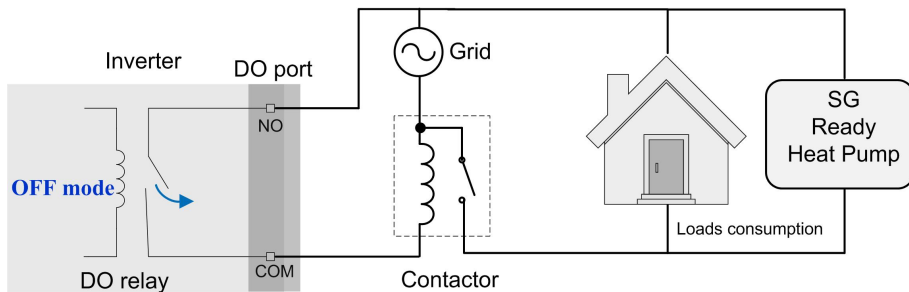

figure 8-25 DO Operation in Switch Mode

**Intelligent Mode**

The system will control the load operation according to the power optimization algorithm of energy management.

During the setting interval, the DO function will be enabled to power on the load if the excess PV energy exceeds the optimized power value.

Notice:

The intelligent mode is disabled in an off-grid system.

- When the inverter is installed to retrofit an existing PV system, the upper limit of optimized power is the sum of the rated power of the hybrid inverter and the rated power of the existing PV inverter.
- Once the intelligent mode is enabled, the DO relay will remain connected for 20 minutes after the DO connection.

Take 09:00 am – 09:30 am and the optimized power of 1000 W as an example.

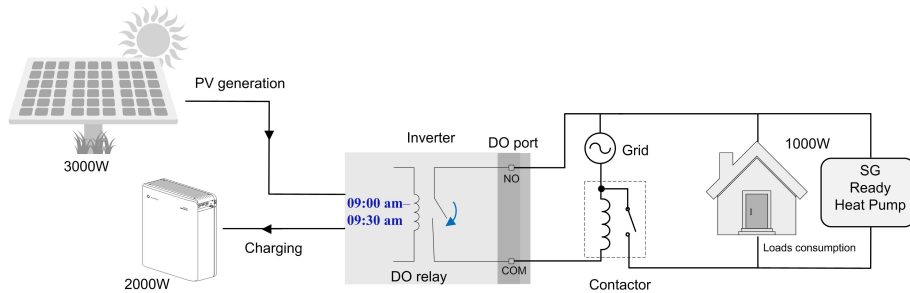

figure 8-26 DO Operation in Intelligent Mode

### 8.10.10 Communication Parameters

Tap **Settings**→**Communication Parameters** to enter the screen, as shown in the following figure.

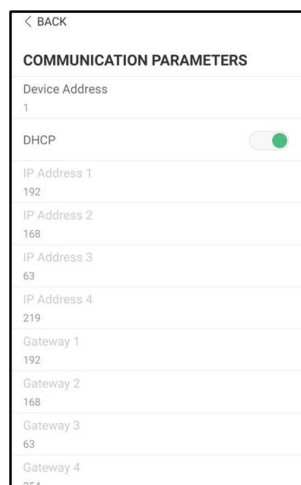



figure 8-27 Communication Parameters

- The device address ranges from 1 to 246.
- The IP address, gateway, subnet mask, preferred DNS server and alternate DNS server can be modified only when the DHCP is set to Off.
- Acquire the IP address, gateway, subnet mask, preferred DNS server and alternate DNS server from the network professional.

### 8.10.11 Firmware Update

To avoid download failure due to poor on-site network signal, it is recommended to download the firmware package to the mobile device in advance.

**step 1** Enable the "Mobile data" of the mobile device.

**step 2** Open the App, tap  at the upper right corner and select **Firmware Download**.

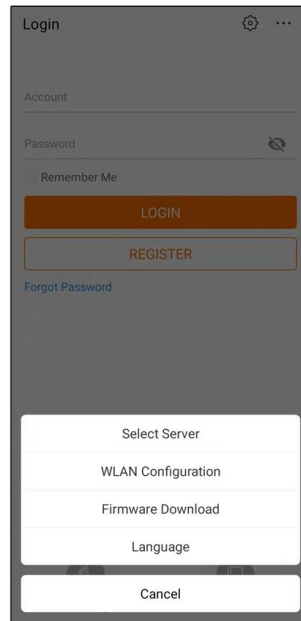

figure 8-28 Firmware Download

**step 3** Select the firmware from the file list and download. Tap **Downloaded** to view successfully downloaded firmware package.

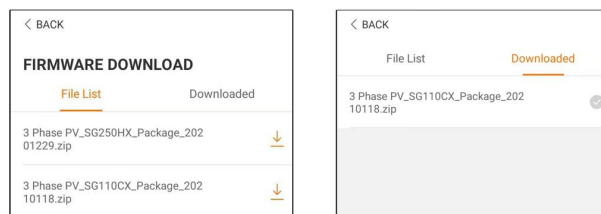

figure 8-29 Downloading Firmware Package

**step 4** Login the App via local access mode. Refer to "8.4 Login".

**step 5** Tab **More** on the App home screen and then tab **Firmware Upgrade**. Select the desired upgrade package to upgrade the firmware.

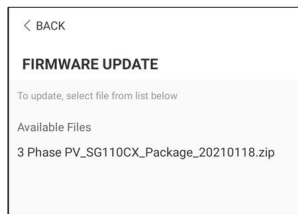

figure 8-30 Updating Firmware

-- End

### 8.10.12 Grounding Detection



Contact SUNGROW to obtain the advanced account and corresponding password before setting the earth detection parameters.

Unauthorized personnel are not allowed to log in with this account. Otherwise, SUNGROW shall not be held liable for any damages caused.

Tap **More**→**Settings**→**Operation Parameters**→**Grounding Detection** to enter the corresponding screen.

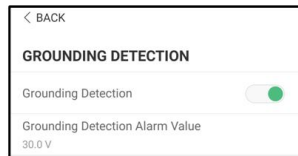

figure 8-31 Grounding Detection

If the grounding detection is enabled, the DO relay will switch on automatically to signal the external alarm if the value exceeds the grounding detection alarm value. The buzzer inside the inverter will beep.

The PV insulation resistance fault (fault sub-code 039) will trigger the DO relay to signal the external alarm.

### 8.10.13 Parallel Configuration

When two or more inverters are connected in parallel, the inverter needs to be set as the master or slave.

Tap **More**→**Settings**→**Power Regulation Parameters**→**Feed-in Limitation** to enter the corresponding screen.

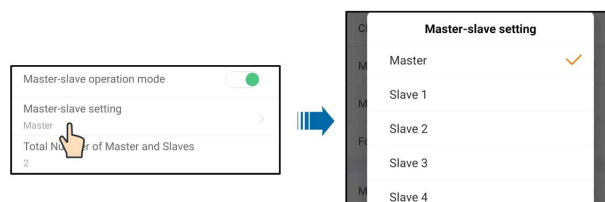

Parameter	Default value	Range
<b>Master-slave operation mode</b>	ON	ON / OFF
<b>Master-slave setting</b>	Master	Master / Slave 1 / Slave 2 / Slave 3 / Slave 4
<b>Total Number of Master and Slaves</b>	2	2 ~ 5

#### 8.10.14 Frequency Shift Power Control

Tap **More**→**Settings**→**Operation Parameters**→**Other Parameters** to enter the corresponding screen.



Parameter	Default value	Range
<b>Frequency Shift Power Control</b>	OFF	ON / OFF
<b>Frequency Shift Test</b>	OFF	ON / OFF
<b>Set Test Frequency</b>	50.00 Hz	50.00 ~ 55.00 Hz

If PV inverters are connected on the AC side during battery-backup operation, the hybrid inverter must be able to limit their output power. This limitation becomes necessary when, for example, the hybrid inverter's battery is fully charged and the power available from the PV system exceeds the power requirement of the connected loads.

To prevent excess energy from overcharging the battery, the hybrid inverter automatically detects the problem and changes the frequency at the AC output. This frequency adjustment is analyzed by the PV inverter. As soon as the power frequency of the battery-backup grid increases beyond the value specified in **Set Test Frequency**, the PV inverter limits its output power accordingly.

Before retrofitting the existing PV system to an off-grid port, the **Frequency Shift Power Control** parameter needs to be enabled. It must be ensured that the connected PV inverters limit their power at the AC output via the hybrid inverter due to changes in frequency. The frequency-dependent active power limitation PF must be set in the PV inverter.



When the battery SOC is greater than 85%, the Hybrid inverter will standby before starting when switching off-grid, and does not support seamless switching.



## 9 System Decommissioning

### 9.1 Decommissioning the Inverter

#### 9.1.1 Disconnecting the Inverter

For maintenance or other service work, the inverter must be switched off.

Proceed as follows to disconnect the inverter from the AC and DC power sources. Lethal voltages or damage to the inverter will follow if otherwise.

**step 1** Stop the inverter via the iSolarCloud App. For details, see "8.10.1 System Parameters".

**step 2** Disconnect the external AC circuit breaker and secure it against reconnection.

**step 3** Rotate the DC switch to the "OFF" position for disconnecting all of the PV string inputs.

**step 4** Disconnect the DC circuit breaker between the battery and the inverter.

#### NOTICE

Do not power on the system again for 1 minute after the disconnection.

**step 5** Wait about 10 minutes until the capacitors inside the inverter completely discharge.

**step 6** Ensure that the DC cable is current-free via a current clamp.

**step 7** Insert a MC4 wrench into the notch and press the wrench with an appropriate force to remove the DC connector.

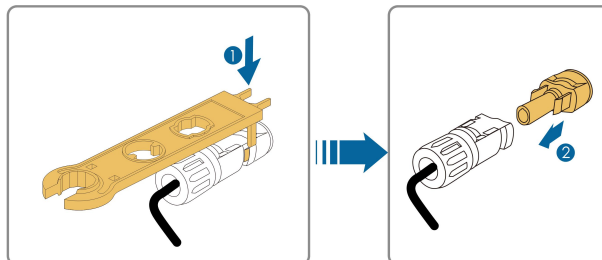

**step 8 Optional:** Remove the block with the Phillips screwdriver.

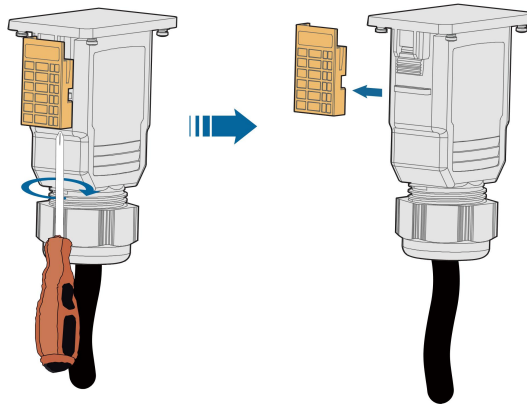

**step 9** Lay the tool in the location of snap and press the tool down to remove the AC connector. Ensure that the AC wiring terminals are voltage-free via a multimeter, and remove the AC wires and communication wires.

**step 10** Use the multimeter to measure the port voltage of the battery. Disconnect the power cables after the voltage is zero.

**step 11** Install the MC4 waterproof plugs.



For further disconnection and reconnection instructions, please visit the webpage of respective component manufacturer.

-- End

### 9.1.2 Dismantling the Inverter

#### **⚠ CAUTION**

**Risk of burn injuries and electric shock!**

**Do not touch any inner live parts until for at least 10 minutes after disconnecting the inverter from the utility grid, the PV inputs and the battery module..**

**step 1** Refer to "[6 Electrical Connection](#)" for the inverter disconnection of all cables in reverse steps.

**step 2** Dismantle the inverter referring to "[5 Mechanical Mounting](#)" in reverse steps.

**step 3** If necessary, remove the wall-mounting bracket from the wall.

**step 4** If the inverter will be reinstalled in the future, please refer to "[4.3 Inverter Storage](#)" for a proper conservation.

-- End

### 9.1.3 Disposal of the Inverter

Users take the responsibility for the disposal of the inverter.

**NOTICE**

Some parts and devices of the inverter, such as the capacitors, may cause environmental pollution.

Do not dispose of the product together with household waste but in accordance with the disposal regulations for electronic waste applicable at the installation site.

## 9.2 Decommissioning the Battery

Decommission the battery in the system after the inverter is decommissioned. Proceed as follows to decommission a Li-ion battery.

- step 1** Disconnect the DC circuit breaker between the battery and the inverter.
- step 2** Disconnect the communication cable between the battery and the inverter.
- step 3 (Optional)** Turn off the switch on LG Chem Li-ion battery or BYD Li-ion battery, if applicable.
- step 4** Wait for about 1 minute and then use the multimeter to measure the port voltage of the battery.
- step 5** If the battery port voltage is zero, disconnect the power cables from the battery module.

-- End



SUNGROW is not liable for disposal of the battery.

# 10 Troubleshooting and Maintenance

## 10.1 Troubleshooting

When an alarm occurs, the alarm information can be viewed through the App.

Alarm ID and corrective measures are as follows:

Alarm ID	Alarm Name	Corrective Measures
002, 003, 014, 015	Grid overvoltage	<p>Generally, the inverter will be reconnected to the grid after the grid recovers. If the alarm occurs frequently:</p> <ol style="list-style-type: none"><li>1. Measure the grid voltage, and contact the local utility grid company for solutions if the grid voltage exceeds the specified value.</li><li>2. Check, through the App, whether the protection parameters are appropriately set.</li><li>3. Check whether the cross-sectional area of the AC cable meets the requirement.</li><li>4. If the alarm persists, contact SUNGROW.</li></ol>
004, 005	Grid undervoltage	<p>Generally, the inverter will be reconnected to the grid after the grid recovers. If the alarm occurs frequently:</p> <ol style="list-style-type: none"><li>1. Measure the grid voltage, and contact the local utility grid company for solutions if the grid voltage is below the specified value.</li><li>2. Check, through the App, whether the protection parameters are appropriately set.</li><li>3. Check whether the AC cable is firmly in place.</li><li>4. If the alarm persists, contact SUNGROW.</li></ol>

Alarm ID	Alarm Name	Corrective Measures
008	Grid overfrequency	Generally, the inverter will be reconnected to the grid after the grid recovers. If the alarm occurs frequently:  1. Measure the grid frequency, and contact the local utility grid company for solutions if the grid frequency is beyond the specified range.
009	Grid underfrequency	2. Check, through the App, whether the protection parameters are appropriately set.  3. If the alarm persists, contact SUNGROW.
010	Grid Power Outage	Generally, the inverter will be reconnected to the grid after the grid recovers. If the alarm occurs frequently:  1. Check whether the grid supplies power reliably. 2. Check whether the AC cable is firmly in place. 3. Check whether the AC cable is correctly connected (whether the live wire and the N wire are in correct place). 4. Check whether the AC switch or circuit breaker is disconnected. 5. If the alarm persists, contact SUNGROW.
012	Excessive leakage current	1. The alarm can be caused by poor sunlight or damp environment, and the inverter will be reconnected to the grid after the environment is improved. 2. If the environment is normal, check whether the AC and DC cables are well insulated. 3. If the alarm persists, contact SUNGROW.
013	Grid abnormal	Generally, the inverter will be reconnected to the grid after the grid recovers. If the alarm occurs frequently:  1. Measure the grid frequency, and contact the local utility grid company for solutions if the grid frequency exceeds the specified value. 2. If the alarm persists, contact SUNGROW.

Alarm ID	Alarm Name	Corrective Measures
017	Grid voltage unbalance	<p>Generally, the inverter will be reconnected to the grid after the grid recovers. If the alarm occurs frequently:</p> <ol style="list-style-type: none"> <li>1. Measure the grid voltage. If grid phase voltage differs greatly, contact the utility grid company for solutions.</li> <li>2. If the voltage difference between the three phases is within the permissible range of the local utility grid company, modify the parameter setting through the App.</li> <li>3. If the alarm persists, contact SUNGROW.</li> </ol>
028, 029	PV reverse connection fault	<ol style="list-style-type: none"> <li>1. Check whether the corresponding string is of reverse polarity. If so, disconnect the DC switch and adjust the polarity when the solar radiation is low and the string current drops below 0.5A.</li> <li>2. Check whether PV strings connected to the same MPPT have the same number of PV modules. If not, take corrective measures.</li> <li>3. If the alarm persists, contact SUNGROW.</li> </ol>
037	High ambient temperature	<ol style="list-style-type: none"> <li>1. Check whether the inverter is directly exposed to sunlight. If so, take some shading measures.</li> <li>2. Check and clean the air ducts.</li> <li>3. Check whether the sub-alarm ID 070 (fan alarm) occurs through the App. If so, replace the faulty fan.</li> <li>4. If the alarm persists, contact SUNGROW.</li> </ol>

Alarm ID	Alarm Name	Corrective Measures
039	Low ISO resistance	<p>Wait for the inverter to recover. If the fault occurs frequently:</p> <ol style="list-style-type: none"> <li>1. Check whether the insulation resistance protection value is extremely large through the App, and ensure that it complies with the local regulations.</li> <li>2. Check the resistance to ground from the PV module/cable. Take corrective measures in case of leading to short circuit or damaged insulation layer.</li> <li>3. If the cable is normal and the alarm occurs on rainy days, check it again when the weather turns fine.</li> <li>4. If the fault occurs on a cloudy day without rain but there is stagnant water or vegetation on site, clear the water and vegetation. If the fault persists, check it again when the weather turns fine.</li> <li>5. If the alarm persists, contact SUNGROW.</li> </ol>
106	Grounding cable fault	<ol style="list-style-type: none"> <li>1. Check whether the AC cable is correctly connected.</li> <li>2. Check whether the grounding cable and wire cores are wrongly insulated.</li> <li>3. If the alarm persists, contact SUNGROW.</li> </ol>
051	Off-grid load overpower	<ol style="list-style-type: none"> <li>1. Reduce the power of loads connected at the off-grid port, or remove some loads.</li> <li>2. If the alarm persists, contact SUNGROW.</li> </ol>
714	BMS communication error	<ol style="list-style-type: none"> <li>1. Check whether the communication cable and corresponding wiring terminal are abnormal. If so, take corrective measures to ensure reliable connection.</li> <li>2. Reinstall the Smart Energy Meter communication cable.</li> <li>3. If the alarm persists, contact SUNGROW.</li> </ol>

Alarm ID	Alarm Name	Corrective Measures
932 – 935, 937, 939	Battery alarm	<p>Generally, the battery can automatically recover. In case the alarm persist for a long time:</p> <ol style="list-style-type: none"> <li>1. If the alarm is caused by ambient temperature, such as over temperature alarm or low temperature alarm, take measures to change the ambient temperature, such as improving heat dissipation conditions.</li> <li>2. If the fault persists, contact battery manufacturer.</li> </ol>
703, 711, 712, 715, 732 – 736, 739, 832 – 833, 835 – 837	Battery abnormal	<ol style="list-style-type: none"> <li>1. In case of abnormal battery voltage, check whether the battery power cable connection is abnormal (reverse connection, loose, etc.). If so, connect the battery power cable correctly.</li> <li>2. Check whether the battery real-time voltage is abnormal if the battery power cable is correctly connected. If so, contact the battery manufacturer. If not, contact SUNGROW.</li> <li>3. In case of abnormal battery temperature, take measures to change the ambient temperature, such as improving heat dissipation conditions.</li> <li>4. If the fault persists, contact battery manufacturer.</li> </ol>



Alarm ID	Alarm Name	Corrective Measures
502-504, 507, 508, 510, 513, 516 – 518	System alarm	The inverter can operate normally. 1. Check whether the related cable connection and terminals are abnormal, and check whether the ambient environment is abnormal. If so, take corrective measures. 2. If the alarm persists, contact SUNGROW.
006, 007, 011, 019, 021, 025, 038, 040 – 042, 048 – 050, 052 – 054, 056, 064 – 067, 100 – 102, 105, 107, 113, 117, 200 – 205, 300, 303 – 305, 308 – 316, 320, 600, 601, 605, 608, 612, 616, 620, 624	System fault	1. Wait for the inverter to recover. 2. Disconnect the AC and DC switches or circuit breakers, and connect them again after 15 minutes. 3. If the alarm persists, contact SUNGROW.

## 10.2 Maintenance

### 10.2.1 Maintenance Notices

#### DANGER

Risk of inverter damage or personal injury due to incorrect service!

- Always keep in mind that the inverter is powered by dual sources: PV strings and utility grid.

Before any service work, observe the following procedure.

- Disconnect the AC circuit breaker and then set the DC load-break switch of the inverter to OFF;
- The DC switch can be secured with a lock in the OFF position or a certain angle beyond the OFF position.
- Wait at least 10 minutes for inner capacitors to discharge completely;
- Verify that there is no voltage or current before pulling any connector.

#### CAUTION

Keep non-related persons away!

A temporary warning sign or barrier must be posted to keep non-related persons away while performing electrical connection and service work.

#### NOTICE

- Restart the inverter only after removing the fault that impairs safety performance.
- As the inverter contains no component parts that can be maintained, never arbitrarily replace any internal components.
- For any maintenance need, please contact SUNGROW. Otherwise, SUNGROW shall not be held liable for any damage caused.



Servicing of the device in accordance with the manual should never be undertaken in the absence of proper tools, test equipments or the latest revision of the manual which has been clearly and thoroughly understood.

## 10.2.2 Routine Maintenance

Item	Method	Period
General status of the system	<ul style="list-style-type: none"> <li>• Visual check for any damage or deformation of the inverter.</li> <li>• Check any abnormal noise during the operation.</li> <li>• Check each operation parameter.</li> <li>• Be sure that nothing covers the heat sink of the inverter.</li> </ul>	Every 6 months
Electrical connection	Check whether there is damage to the cables, especially the surface in contact with metal.	6 months after commissioning and then once or twice a year.

## 10.2.3 Replacing the Button Cell

### DANGER

Disconnect the inverter from the grid first, then the PV strings and the battery before any maintenance work.

Lethal voltage still exists in the inverter. Please wait at least 10 minutes and then perform maintenance work.

There is a button cell on the inner PCB board. Contact SUNGROW for replacement when the relevant fault alarm occurs.

Check the fastener, appearance, voltage, and resistance quarterly and annually.

# 11 Appendix

## 11.1 Technical Data

Parameters	SH5.0RT	SH6.0RT
<b>PV Input</b>		
Max. PV input power	7500 W	9000 W
Max. PV input voltage	1000 V	1000 V
Startup voltage	180 V	250 V
Nominal input voltage	600 V	600 V
MPP voltage range	150 V ... 950 V	200 V ... 950 V
MPP voltage range for nominal power	210 V ... 850 V	250 V ... 850 V
No. of MPPTs	2	
Max. number of PV strings per MPPT	1 / 1	
Max. PV input current	25 A (12.5 A / 12.5 A)	
Max. current for input connector	16 A	
Short-circuit current of PV input	32 A (16 A / 16 A)	
<b>Battery Data</b>		
Battery type	Li-ion battery	
Battery voltage	150 V ... 600 V	
Max. charge / discharge current*	30 A / 30 A	
Max. charge / discharge power	7500 W / 6000 W	9000 W / 7200 W
<b>AC Input and Output Data</b>		
Nominal AC output power	5000 W	6000 W
Nominal AC output current	7.3 A	8.7 A
Max. input power from grid	12500 W	15000 W
Max. AC output apparent power	5000 VA	6000 VA
Max. AC output current	7.6 A	9.1 A
Nominal AC voltage	3 / N / PE, 220 / 380 V; 230 / 400 V; 240 / 415 V	

Parameters	SH5.0RT	SH6.0RT
AC voltage range	270 Vac ... 480 Vac	
Nominal grid frequency	50 Hz / 60 Hz	
Grid frequency range	45 Hz ... 55 Hz / 55 Hz ... 65 Hz	
Total Harmonic Distortion (THD)	< 3 % (of nominal power)	
DC current injection	< 0.5 % In	
Power factor	> 0.99 / 0.8 leading to 0.8 lagging	
<b>Protection</b>		
LVRT	Yes	
Anti-islanding protection	Yes	
AC short circuit protection	Yes	
Leakage current protection	Yes	
DC switch (solar)	Yes	
DC fuse (battery)	Yes	
Over-voltage category	III [Mains], II [PV] [Battery]	
SPD	DC Type II / AC Type II	
Battery input reverse polarity protection	Yes	
Parallel operation on grid port / Max. No. of inverters	Master-slave mode / 5	
**		
<b>System Data</b>		
Max. efficiency	98.0 %	98.2 %
Max. European efficiency	97.2 %	97.5 %
Isolation method (solar / battery)	Transformerless / Transformerless	
Ingress protection (IP) rating	IP65	
Operating ambient temperature range	-25 °C...60 °C	
Allowable relative humidity range (Non-condensing)	0...100 %	
Cooling method	Natural convection	
Max. operating altitude	4000 m (> 3000 m derating)	
Noise (Typical)	30 dB(A)	
Display	LED	
Communication	RS485, WLAN, Ethernet, CAN, 4 × DI, 1 × DO	
DC connection type	MC4 (PV) / Sunclix (Battery)	

Parameters	SH5.0RT	SH6.0RT
AC connection type	Plug and play connector	
<b>Mechanical Data</b>		
Dimensions (W x H x D)	460 mm x 540 mm x 170 mm	
Mounting method	Wall-mounting bracket	
Weight	27 kg	
<b>Backup Data</b>		
Nominal voltage	3 / N / PE, 220 Vac / 230 Vac / 240 Vac	
Frequency range	50 Hz / 60 Hz	
Total harmonic factor output voltage	2%	
Switch time to emergency mode	< 20 ms	
Nominal output power	5000 W / 5000 VA	6000 W / 6000 VA
Peak output power ***	6000 W / 6000 VA, 5min 10000 W / 10000 VA, 10 s	7200 W / 7200 VA, 5min 10000 W / 10000 VA, 10 s
Rated output current for backup load during on grid mode	3 x 18.5 A	

\* Depending on the connected battery

\*\* Germany is available for 2 inverters parallel in maximum if no ripple control is used in system.

\*\*\* Can be reached only if PV and battery power is enough.

Parameters	SH8.0RT	SH10RT
<b>PV Input</b>		
Max. PV input power	12000 W	15000 W
Max. PV input voltage	1000 V	
Startup voltage	250 V	
Nominal input voltage	600 V	
MPP voltage range	200 V...950 V	
MPP voltage range for nominal power	330 V...850 V	280 V...850 V
No. of MPPTs	2	
Max. number of PV strings per MPPT	1 / 1	1 / 2
Max. PV input current	25 A (12.5 A / 12.5 A)	37.5 A (12.5 A / 25 A)

Parameters	SH8.0RT	SH10RT
Max. current for input connector		16 A
Short-circuit current of PV input	32 A (16 A / 16 A)	48 A (16 A / 32 A)
<b>Battery Data</b>		
Battery type		Li-ion battery
Battery voltage		150 V...600 V
Max. charge / discharge current *		30 A / 30 A
Max. charge / discharge power		10600 W / 10600 W
<b>AC Input and Output Data</b>		
Nominal AC output power	8000 W	10000 W
Nominal AC output current	11.6 A	14.5 A
Max. input power from grid	18600 W	20600 W
Max. AC output apparent power	8000 VA	10000 VA
Max. AC output current	12.1 A	15.2 A
Nominal AC voltage	3 / N / PE, 220 / 380 V; 230 / 400 V; 240 / 415 V	
AC voltage range	270 Vac...480 Vac	
Nominal grid frequency	50 Hz / 60 Hz	
Grid frequency range	45 Hz...55 Hz / 55 Hz...65 Hz	
Total Harmonic Distortion (THD)	< 3 % (of nominal power)	
DC current injection	< 0.5 % I <sub>n</sub>	
Power factor	> 0.99 / 0.8 leading to 0.8 lagging	
<b>Protection</b>		
LVRT	Yes	
Anti-islanding protection	Yes	
AC short circuit protection	Yes	
Leakage current protection	Yes	
DC switch (solar)	Yes	
DC fuse (battery)	Yes	
Over-voltage category	III [Mains], II [PV] [Battery]	
SPD	DC Type II / AC Type II	
Battery input reverse polarity protection	Yes	

Parameters	SH8.0RT	SH10RT
Parallel operation on grid port / Max. No. of inverters	Master-slave mode / 5	
**		
<b>System Data</b>		
Max. efficiency	98.4 %	98.4 %
Max. European efficiency	97.9 %	97.9 %
Isolation method (solar / battery)	Transformerless / Transformerless	
Ingress protection (IP) rating	IP65	
Operating ambient temperature range	-25 °C...60 °C	
Allowable relative humidity range (non-condensing)	0...100 %	
Cooling method	Natural convection	
Max. operating altitude	4000 m (> 3000 m derating)	
Noise (Typical)	30 dB(A)	
Display	LED	
Communication	RS485, WLAN, Ethernet, CAN, 4 × DI, 1 × DO	
DC connection type	MC4 (PV) / Sunclix (Battery)	
AC connection type	Plug and play connector	
<b>Mechanical Data</b>		
Dimensions (W x H x D)	460 mm x 540 mm x 170 mm	
Mounting method	Wall-mounting bracket	
Weight	27 kg	
<b>Backup Data</b>		
Nominal voltage	3 / N / PE, 220 Vac / 230 Vac / 240 Vac	
Frequency range	50 Hz / 60 Hz	
Total harmonic factor output voltage	2%	
Switch time to emergency mode	< 20 ms	
Nominal output power	8000 W / 8000 VA	10000 W / 10000 VA
Peak output power ***	12000 W / 12000 VA, 5min	
Rated output current for backup load during on grid mode	3 x 18.5 A	

\* Depending on the connected battery



\*\* Germany is available for 2 inverters parallel in maximum if no ripple control is used in system.

\*\*\* Can be reached only if PV and battery power is enough.

## 11.2 The Compatibility for Backup under Off-grid Scenario

The information below is about the compatibility for backup of SUNGROW SH5.0RT / SH6.0RT / SH8.0RT / SH10RT inverter under off-grid scenario. Please refer to this information before you use the back-up model of the four inverters under off-grid situation.

### Main electrical panel

Type	Load Power			
	SH5.0RT	SH6.0RT	SH8.0RT	SH10RT
Dust collector	1 kW	1 kW	1 kW	1.3 kW
Water heater / Kettle / Iron / Oven / Toaster / Geothermal blanket / Rice cooker	1.5 kW	1.8 kW	2.4 kW	3 kW (2.5 kW with SBR096)
Microwave oven	1 kW	1 kW	1.3 kW	1.5 kW
Refrigerator	1 kW	1 kW	1 kW	1 kW
TV / Computer	1 kW	1 kW	1 kW	1 kW
Bath heater	1 kW	1.5 kW	2 kW	2.5 kW
Fluorescent / LED lights	1 kW	1 kW	1 kW	1.3 kW
Electric fan / Ceiling fan	1 kW	1.2 kW	1.6 kW	2 kW

### Additional large appliances

Type	SH5.0RT	SH6.0RT	SH8.0RT	SH10RT
Conditioner (Frequency conversion)	1P	1P	1P	1.5P



The data of the compatibility for backup of SH5.0RT / SH6.0RT / SH8.0RT / SH10RT are based on the test with SUNGROW SBR096/128/160/192/224/256 batteries (-20 ~ 53 °C, 5~100% SOC). For the actual application, please refer to the maximum output capacity of the battery used.

For those loads that not covered in this document, please contact SUNGROW to make sure the compatibility of the specific loads under off-grid scenario. SUNGROW will not be held responsible for the usage of any load without confirmation. We will keep updating this document, please contact SUNGROW if there are any relevant issues.

## 11.3 Quality Assurance

When product faults occur during the warranty period, SUNGROW will provide free service or replace the product with a new one.

### **Evidence**

During the warranty period, the customer shall provide the product purchase invoice and date. In addition, the trademark on the product shall be undamaged and legible. Otherwise, SUNGROW has the right to refuse to honor the quality guarantee.

### **Conditions**

- After replacement, unqualified products shall be processed by SUNGROW.
- The customer shall give SUNGROW a reasonable period to repair the faulty device.

### **Exclusion of Liability**

In the following circumstances, SUNGROW has the right to refuse to honor the quality guarantee:

- The free warranty period for the whole machine/components has expired.
- The device is damaged during transport.
- The device is incorrectly installed, refitted, or used.
- The device operates in harsh conditions beyond those described in this manual.
- The fault or damage is caused by installation, repairs, modification, or disassembly performed by a service provider or personnel not from SUNGROW.
- The fault or damage is caused by the use of non-standard or non-SUNGROW components or software.
- The installation and use range are beyond stipulations of relevant international standards.
- The damage is caused by unexpected natural factors.

For faulty products in any of above cases, if the customer requests maintenance, paid maintenance service may be provided based on the judgment of SUNGROW.

## 11.4 Contact Information

Should you have any question about this product, please contact us.

We need the following information to provide you the best assistance:

- Model of the device
- Serial number of the device
- Fault code/name
- Brief description of the problem

<p><b>China (HQ)</b> Sungrow Power Supply Co., Ltd Hefei +86 551 65327834 <a href="mailto:service@sungrowpower.com">service@sungrowpower.com</a></p>	<p><b>Australia</b> Sungrow Australia Group Pty. Ltd. Sydney +61 2 9922 1522 <a href="mailto:service@sungrowpower.com.au">service@sungrowpower.com.au</a></p>
<p><b>Brazil</b> Sungrow Do Brasil Sao Paulo +55 0800 677 6000 <a href="mailto:latam.service@sungrowamericas.com">latam.service@sungrowamericas.com</a></p>	<p><b>France</b> Sungrow France Lyon +33420102107 <a href="mailto:service@sungrow-emea.com">service@sungrow-emea.com</a></p>
<p><b>Germany, Austria, Switzerland</b> Sungrow Deutschland GmbH Munich +49 0800 4327 9289 <a href="mailto:service@sungrow-emea.com">service@sungrow-emea.com</a></p>	<p><b>Greece</b> Service Partner – Survey Digital +30 2391052757 <a href="mailto:service@sungrow-emea.com">service@sungrow-emea.com</a></p>
<p><b>India</b> Sungrow (India) Private Limited Gurgaon +91 080 41201350 <a href="mailto:service@in.sungrowpower.com">service@in.sungrowpower.com</a></p>	<p><b>Italy</b> Sungrow Italy Verona +39 0800 974739 (Residential) +39 045 4752117 (Others) <a href="mailto:service@sungrow-emea.com">service@sungrow-emea.com</a></p>
<p><b>Japan</b> Sungrow Japan K.K. Tokyo + 81 3 6262 9917 <a href="mailto:service@jp.sungrowpower.com">service@jp.sungrowpower.com</a></p>	<p><b>Korea</b> Sungrow Power Korea Limited Seoul +82 70 7719 1889 <a href="mailto:service@kr.sungrowpower.com">service@kr.sungrowpower.com</a></p>
<p><b>Malaysia</b> Sungrow SEA Selangor Darul Ehsan +60 19 897 3360 <a href="mailto:service@my.sungrowpower.com">service@my.sungrowpower.com</a></p>	<p><b>Philippines</b> Sungrow Power Supply Co., Ltd Mandaluyong City +63 9173022769 <a href="mailto:service@ph.sungrowpower.com">service@ph.sungrowpower.com</a></p>
<p><b>Thailand</b> Sungrow Thailand Co., Ltd. Bangkok +66 891246053 <a href="mailto:service@th.sungrowpower.com">service@th.sungrowpower.com</a></p>	<p><b>Spain</b> Sungrow Ib é rica S.A.U. Mutilva +34 948 05 22 04 <a href="mailto:service@sungrow-emea.com">service@sungrow-emea.com</a></p>

<p><b>Romania</b> Service Partner - Elerex <a href="mailto:service@sungrow-emea.com">service@sungrow-emea.com</a></p>	<p><b>Turkey</b> Sungrow Deutschland GmbH Turkey Istanbul +90 216 663 61 80 <a href="mailto:service@sungrow-emea.com">service@sungrow-emea.com</a></p>
<p><b>UK</b> Sungrow Power UK Ltd. Milton Keynes +44 (0) 01908 414127 <a href="mailto:service@sungrow-emea.com">service@sungrow-emea.com</a></p>	<p><b>U.S.A, Mexico</b> Sungrow USA Corporation Phoenix +1 833 747 6937 <a href="mailto:techsupport@sungrow-na.com">techsupport@sungrow-na.com</a></p>
<p><b>Vietnam</b> Sungrow Vietnam Hanoi +84 918 402 140 <a href="mailto:service@vn.sungrowpower.com">service@vn.sungrowpower.com</a></p>	<p><b>Belgium, Netherlands and Luxembourg (Benelus)</b> +31 08000227012 (only for Netherlands) <a href="mailto:service@sungrow-emea.com">service@sungrow-emea.com</a></p>
<p><b>Poland</b> +48 221530484 <a href="mailto:service@sungrow-emea.com">service@sungrow-emea.com</a></p>	<p>-</p>