

Mounting instructions

Green roof

East-west system

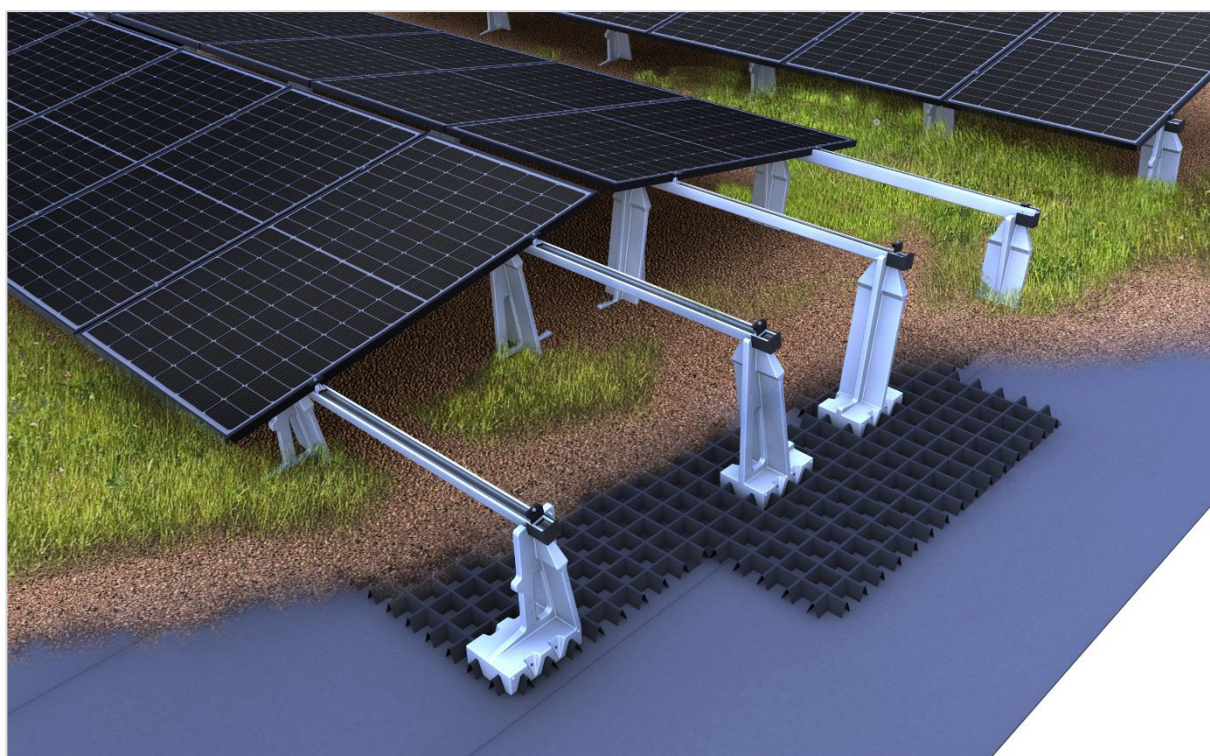
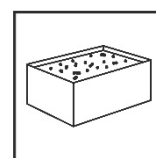

TABLE OF CONTENTS

- 1 Notes 1**
- 2 Mounting system maintenance 4**
- 3 novotegra for green roofs 4**
- 4 System components, tools and equipment 5**
 - 4.1 Required mounting equipment 5
 - 4.2 Mounting system components – optional 6
- 5 Mounting the supporting structure 7**
 - 5.1 Substrate plate installation and support component mounting 7
 - 5.2 Mounting and securing rails 8
 - 5.3 Mounting the modules 9
 - 5.4 Mounting variations 10
- 6 Warranty/ product liability (exclusion)..... 13**

1 Notes

The following instructions are to be understood as generally applicable to our novotegra mounting system and should be applied or interpreted accordingly, regardless of the specific roof type or type of mounting system.

Safety notes

Mounting may only be carried out by skilled and competent persons. Safety clothing must be worn while working in accordance with the relevant national regulations and directives.

The assembly must be carried out by at least two persons so that assistance can be provided in the event of an accident.

All relevant national and locally applicable occupational health and safety regulations, accident prevention regulations, standards, construction regulations and environmental protection regulations, as well as all regulations of the employers' liability insurance associations, must be observed.

The national regulations for working at height or on the roof must be observed.

Electrical work must be carried out in compliance with the national and locally applicable standards and directives and according to the safety regulations for electrical work.

The earthing / equipotential bonding of the mounting system must be carried out in compliance with the national and locally applicable standards and directives.

Hazard classification

Hazard classes are used in accordance with ANSI Z 535 to make the user aware of possible hazardous situations. The hazard class describes the risk in case of non-observance of the safety notes.

Warning symbol with signal word



Hazard class in accordance with ANSI Z 535

DANGER! indicates an immediate hazard that will result in serious injury or death.

WARNING! indicates a potential hazard that could result in serious injury or death.

CAUTION! indicates a potential hazard that could result in minor to moderate injury.

NOTICE! indicates a potentially hazardous situation that could cause damage to the installation or something in its vicinity.

General notes

The goods must be checked for completeness on receipt using the enclosed delivery note.

novotegra GmbH is not responsible for covering the costs or providing guarantees for express deliveries of materials found to be missing during the mounting phase.

As our mounting systems are constantly undergoing further development, mounting procedures or components may change. Please therefore check the latest version of the mounting instructions on our website before mounting. We will be happy to send you the latest versions on request.

The mounting system is suitable for mounting photovoltaic modules with standard market dimensions. Further details can be found in chapter 3.

It is essential to determine the suitability of the mounting system for each respective project by examining the existing roof covering and roof structure in each case.

The roof covering / roof structure / facade must meet the requirements of the mounting system in terms of load-bearing capacity, load-bearing structure and state of preservation.

Requirements for the material of the roof structure / roof covering / facade:

Timber components (rafters/purlins) min. strength class C24: no fungal decay or rotten. OSB with material quality OSB 3.

Steel purlins for stock screw installation exclusively of material grade S235.

Tensile strength $R_{m,min}$ of trapezoidal sheets: steel 360 N/mm²; aluminium 195 N/mm².

Wall construction material: concrete, brick or lime sandstone with a solid or hollow block structure.

The load-bearing capacity of the roof / roof structure (rafters, purlins, trapezoidal sheets, concrete ceilings, number of attachments for seam roofs, etc.) or the facade (wall material) must be checked by the user or a qualified professional.

The user must consider the relevant physical factors of the building regarding insulation penetrations (e.g. the risk of condensation) when evaluating the project.

Mounting notes

The components of the novotegra mounting system are exclusively intended for the installation of photovoltaic modules. The choice of mounting system components depends on the roof type of the building.

Proper use of the novotegra mounting system requires strict compliance with the instructions provided in terms of safety precautions and mounting.

Any warranty, guarantee, and liability claims against the manufacturer are void if the system is not used as intended, safety instructions and mounting guidelines are not followed, designated mounting components are not used, or non-compatible third-party components are used. The user is responsible for damage and consequential damage to other components such as photovoltaic modules or to the building itself, as well as for personal injuries.

The installer must read the mounting instructions before starting work. Any questions should be clarified with the manufacturer prior to mounting. The mounting sequence provided in these instructions must be followed.

Ensure that a copy of the mounting instructions is readily accessible near the area where work is taking place on site.

The mounting guidelines of the module manufacturer (including module load, fixing and clamping areas) must be observed and followed.

Prior to starting work, a static calculation of the mounting system must be performed according to the loads to be applied for the specific construction project in line with national standards. Relevant mounting details (such as the roof hook spacing, screw lengths, projections, or the distance between the base troughs and the required ballast) should be determined by means of a static calculation using the Solar-Planit design software.

The permissible roof pitch for using the mounting system according to these mounting instructions is 0 to 60 degrees for parallel installation on pitched roofs and 0 to 5 degrees for elevated installation on flat roofs. Facade systems should be mounted parallel to the facade.

For parallel roof mounting, two module support rails must be symmetrically mounted beneath each module using the clamping system to ensure even load distribution into the supporting structure. Alternatively, parallel roof mounting can also be achieved using insertion rails.

The specified fastening torques must be adhered to and periodically checked on-site.

Static calculation guidelines

The mounting system must be statically calculated for each individual project using the Solar-Planit design software. novotegra GmbH handles these calculations, except in the case of facade systems.

The static calculation determines the load-bearing capacity of the novotegra mounting system and also considers how it is secured to the building (rafters, purlins, trapezoidal sheet metal, etc.). The load transfer within the building is not taken into consideration (structural analysis on site).

The load-bearing capacity of the mounting system components is determined based on the planned module arrangement and the provided roof information (project data collection). Deviations from the plan once on site may lead to different results.

The load assumptions (load and roof layout) are country-specific and follow the requirements stipulated in the load standards of the Eurocodes. The applicable loads for Switzerland are determined in accordance with SIA 261.

On pitched roofs, modules must not be mounted beyond the eaves, ridge or fascia, or over the facade (increased wind load). At the ridge, modules may be mounted up to a maximum imaginary horizontal line with the ridge tile, and at the eaves, they may be mounted flush with the edge of the roof covering. In the fascia area, modules may extend up to the end of the roof covering in terms of load.

In case of exposed building locations (e.g. wind load on the side of a hill) or snow accumulations (e.g. dormers, snow guards, or roof structures such as skylights), the user is responsible for considering the requirements of the load standards of the Eurocodes or SIA 261 (Switzerland). These cases are not taken into consideration by the design software.

The static calculation of the mounting system is based on symmetrical placement of the modules on the mounting rails on the longitudinal side of the modules (parallel clamping systems) or on the support components (elevated installation) for even load distribution into the supporting structure. In the case of the insertion system, even load distribution is calculated with a cross-rail connection.

The results obtained from the design software, such as the spacing of fixings (e.g. roof hooks, stock screws, clamps), rail lengths and the number of fixings (e.g. direct attachment to trapezoidal sheets), projections (e.g. rail or roof hook overhangs), the spacing of base troughs and the number of fixings (e.g. rail joint), and other calculation notes must be considered and followed.

novotegra is tested and certified by TÜV Rheinland:



2 Mounting system maintenance

The mounting system must be checked for stability and operation at regular intervals during system maintenance.

Besides the visual inspection of the components, we recommend random connection checks. The installation should be checked regularly for shady areas due to vegetation growth.

The system can be removed by following the steps listed below in reverse order.

Maintenance work must be carried out by a specialist company with proven experience in electrical systems and working with mounting systems.

3 novotegra for green roofs

These mounting instructions describe the installation of the supporting structure on roofs with sheet or bitumen waterproofing. They also apply to roofs topped with gravel, as well as green roofs.

On flat roofs without parapets, the modules must be mounted at a distance of at least 1.50 metres to the edge of the roof. On flat roofs with parapets, a minimum distance of at least 50 centimetres must be maintained between the module edge and the inner edge of the parapet, or rather, the distance to the edge must be taken into account after the individual calculation in the planning software to ensure that the general conditions of the wind tunnel tests can be maintained.

Depending on the roof seal material, separation and/or protection membranes may need to be added between the roof seal and the supporting structure. This must be agreed upon directly between the company installing the photovoltaic system, the building owner and the specialist roof sealing company.

The supporting structure is installed without puncturing the roof. The photovoltaic system is secured against wind suction with ballasting (substrate or suitable stones) on the basis of the results of the wind tunnel tests for the system. The required substrate or ballast height must be determined specifically for each project with the planning software. The ballasting applies to the planned installation; deviations from the plan by the installer may lead to different results.

The installation sliding analysis is carried out with a friction coefficient of $\mu = 0.5$. This value must be checked by the installer before installation. By determining the friction coefficient in advance, the installer can analyse the determined value as part of the planning process.











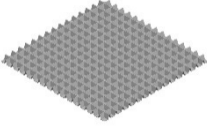
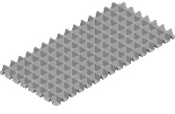





General conditions to be observed in accordance with wind tunnel test results:

- Roof pitch = 0–5 degrees
- Flat roofs with and without parapet
- Distance from system to roof edge (without parapet) = 1.50 m
- Distance from system to parapet (inside edge) = refer to planning documents; min. 50 cm
- Module length = max. 1.85 m
- Module length = max. 1.34 m
- Module positioning: vertical
- Elevation angle (fixed) = 10°
- Distance between rows = refer to planning documents

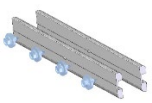

The mounting system is designed for loads up to 2.4 kN/m² (2,400 Pa). The module is clamped (clamping area 11 x 52mm) along the long side. Any potentially existing drainage openings on the module frames must not be obstructed; the same applies to the formations on the supporting components designed for this purpose.

4 System components, tools and equipment

4.1 Required mounting equipment









Figure	Tool	Component*	Product group
		Green roof substrate plate Material: Recycled HDPE	Substrate layer / protection layer
		Half green roof substrate plate Material: Recycled HDPE	Substrate layer / protection layer
		Green roof module support high M12 Material: Recycled plastic	Elevation
		Green roof module support deep M12 Material: Recycled plastic	Elevation
		Mounting screw for green roof support, 6x80 mm Material: Stainless steel Tool: TX25	Fixings
		M12 flange lock nut Material: Aluminium Tool: 18 mm WAF	Fixings
		C-rail Material: Aluminium	Profile rail
		Rail connector set C Material: Aluminium and stainless steel Tool: Special long nut socket 18 mm WAF	Rail connector and floating bearing
		Rail connector set C47 S Material: Aluminium Tool: Socket bit 8 mm WAF	Rail connector
		Middle clamp set C Material: Aluminium, cast aluminium and stainless steel Tool: Socket bit 8 mm WAF	Module fixing
		End clamp set C Material: Aluminium, cast aluminium and stainless steel Tool: Socket bit 8 mm WAF	Module fixing

*The components vary depending on the requirements of the roof, the static calculation and the choice of components, and may deviate from the images above.

Figure	Tool	Use for tool	Application
	Cordless screwdriver	TX25 torx drive Socket bit 8 mm WAF	Component connections Clamp mounting
	Torque key up to at least 8 Nm	Socket bit 8 mm WAF Socket bit 18 mm WAF	Clamp mounting Grounding connector
	Chop saw	---	Cutting rails

**Required components for ballast distribution at edge of installation depending on supporting structure construction.

4.2 Mounting system components – optional

Figure	Tool	Component***	Product group
		Cable-tie clip for profile flange	Cable protection
		Cable clip d = 10 mm	Cable protection
		Grounding connector set 18 WAF Material: Stainless steel Tool: Special long nut socket 18 WAF deep	Accessories and optional components
		Perforated aluminium strip 10,000x20x1 Material: Aluminium Tool: Socket bit 8 mm WAF	Accessories and optional components
		Mounting screw SL 5.5 mm	Fixings
		Contact latch middle clamp	Accessories and optional components

***Optionally available mounting system components for applications such as improving the aesthetics of the installation, cable management or grounding the mounting system.

5 Mounting the supporting structure

Prior to mounting, it is important to measure out the module field on the roof and determine the position of the modules, taking into account any obstacles such as light domes or strips, fans or drains.

The individual mounting steps for the east/west system variations are explained below with reference to the mounting variations (MV) for the different installation options along with the 'south' and 'butterfly' system variations respectively. This is then followed by the respective work sequence.

5.1 Substrate plate installation and support component mounting

Arranging substrate plates

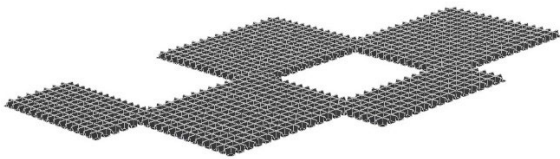

Define the starting point and measure up the first whole substrate plate.
Lay the subsequent substrate plates (whole/half) according to the planning documents.

NOTICE

The substrate plate overlaps must always be taken into account.
The substrate plates must be laid on top of an existing and suitable protection fleece.
The substrate plates are not designed to serve as a retention/drainage layer. If this type of layer is necessary, it should be positioned beneath them.

Positioning and fastening module supports

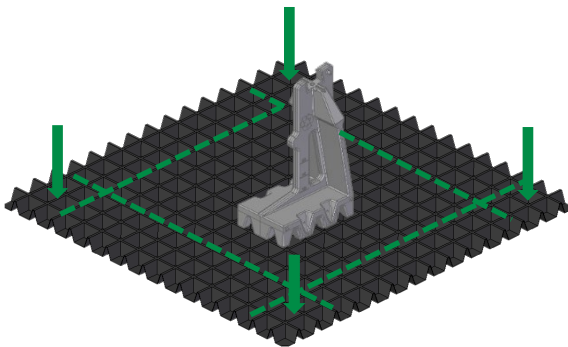

Position module supports (high/low) on the substrate plates according to the planning documents.

Fasten each support at the positions specified with four 6x80 mm support mounting screws.
The supports must be placed in the corners of the (whole) substrate plates. On these corners, the substrate plates (half) may overlap.

NOTICE

The horizontal and vertical substrate plate line grid pattern must be adhered to. Always refer to the planning documents.

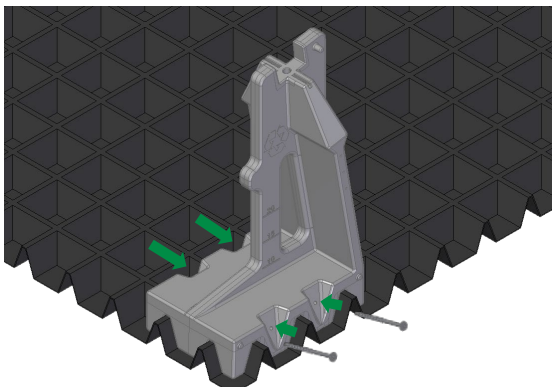

5.2 Mounting and securing rails

Positioning the green roof C-rail

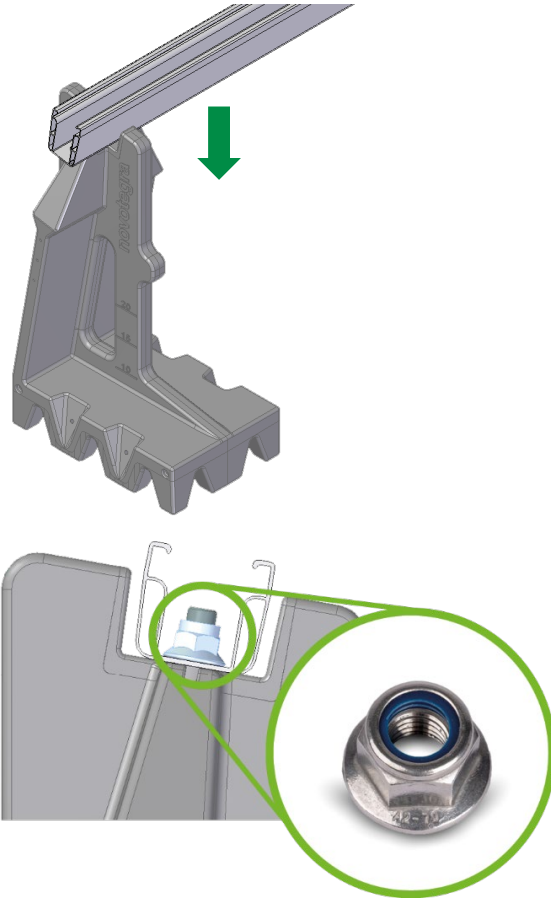

Connecting the C-rail



Place the rail on module supports. Position the elongated hole of the rail over the bolt in the support. Secure the rail to each module support using the M12 flange lock nut.

NOTICE

The flange lock nut features a screw lock. The flange lock nut must fit securely against the bottom of the rail. No pre-tensioning is necessary.

Each rail part must lie on – and be fastened to – at least two module supports.

After the module support and rail installation, the substrate is placed on top. The ballasting is achieved with the substrate; refer to the planning documents for the substrate weight per m². It may be necessary to add additional stones on top of the substrate plates to reinforce the ballast. The mounting system will only stand securely once the required amount of ballast/substrate has been put in place.

WARNING

Observe the accident prevention regulations when sawing the rails.

Only the M12 flange lock nut may be used for securing the rails to the supports.

Align the rail ends tightly, centre the rail connector and connect it to the rail using the mounting screws included in the set. The connector and the number of screws depend on the rail (MV 1.1). The maximum uninterrupted rail length is 17 metres, after which point an expansion joint or floating bearing is required (MV 1.3).

NOTICE

Fastening torque of serrated self-locking flange nuts: 50 Nm.

WARNING

Observe the accident prevention regulations when sawing.

5.3 Mounting the modules

Positioning and clamping the modules

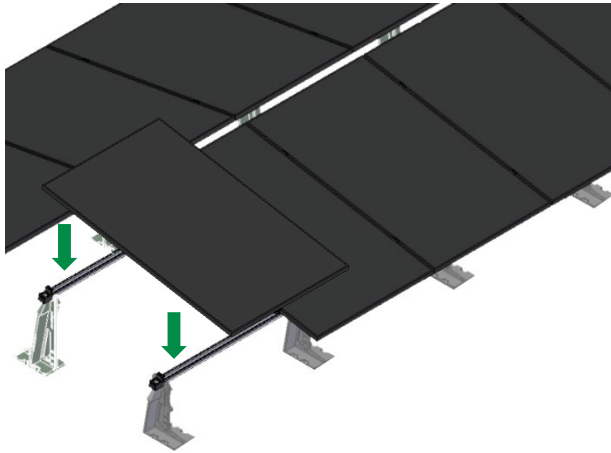

Position the photovoltaic modules upright onto the mounting rails, ensuring that they are straight. End clamps are used at the start and the end of a module row; middle clamps are used between the modules.

NOTICE

The module gap at the ridge must be at least 50 mm.

Mounting the middle and end clamps

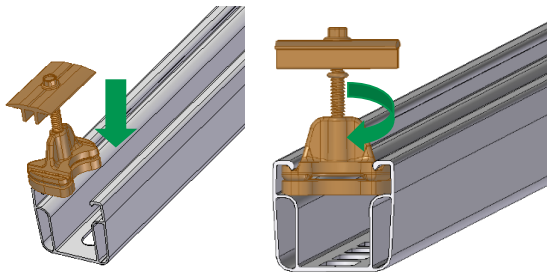

At the clamping point, guide the middle and end clamps into the rail chamber from the top. Then turn the rail nut inside the rail and push the module clamps onto the module frame.

NOTICE

See MV 2.2 for contact latch mounting

Middle and end clamp space requirements

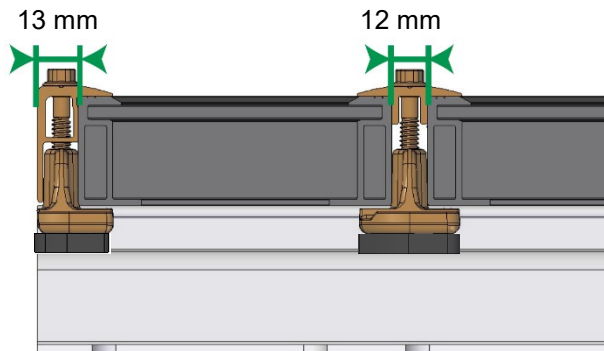

End clamps may be mounted flush with the rail end.

Push the modules completely onto the rail nut of the middle clamps.

NOTICE

Middle clamp fastening torque: 10 Nm

End clamp fastening torque: 8 Nm

5.4 Mounting variations

MV 1 – Rail connector

MV 1.1 – Mounting the rail connector C-rails

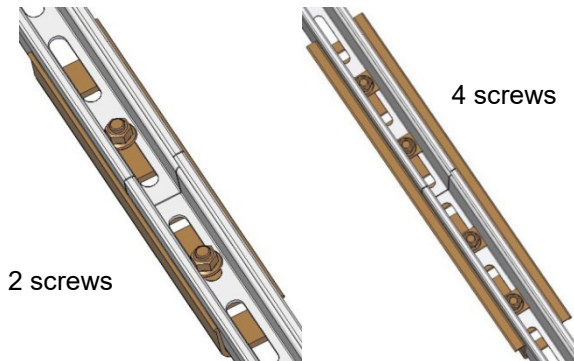

Rail connector:

C-rail 38 and 47 (left):

Connection of the adjacent rail ends with one screw and serrated self-locking flange nut each.

C-rail 71 (right):

Connection of the adjacent rail ends with two screws, washers and serrated self-locking flange nuts each.

NOTICE

Fastening torque of serrated self-locking flange nut: 50 Nm.

MV 1.2 – Mounting the rail connector set C47 S

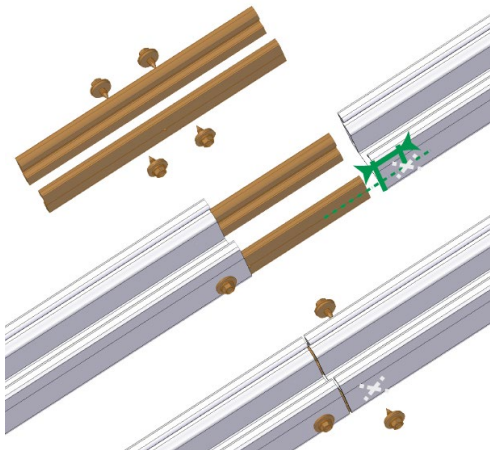

Push the rail connector set (1) halfway into one of the rails to be connected (2) and secure it in place with a self-drilling screw on either side at a distance of approx. 20 mm to the end of the rail. Then, push the other rail fully onto the connector set until both rail ends meet (3) and secure as described above. The maximum uninterrupted rail length is 13 metres, after which point an expansion joint or floating bearing is required.

⚠ WARNING

Observe the accident prevention regulations when sawing.

MV 1.3 – Mounting the floating bearing C-rails

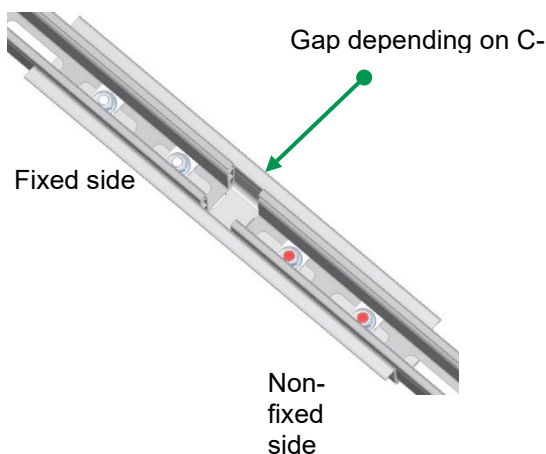

Position the rail ends with a gap, attach the rail connector, and connect it to the rail using the mounting screws on the fixed and non-fixed sides. Tighten the screws firmly on the fixed side. On the non-fixed side, the screws have a red coating and must be loosened after tightening (approximately ½ turn). The maximum rail length with a floating bearing is 40 metres, after which a proper expansion joint should be installed.

NOTICE

Fastening torque of a serrated self-locking flange nut on the fixed side: 50 Nm.

Distance between adjacent rail ends:

- C-rail 38 and 47: 20 mm
- C-rail 71: 40–50 mm

⚠ WARNING

Never install the floating bearing underneath a module.

MV 2 – Grounding

MV 2.1 – Mounting the grounding connector

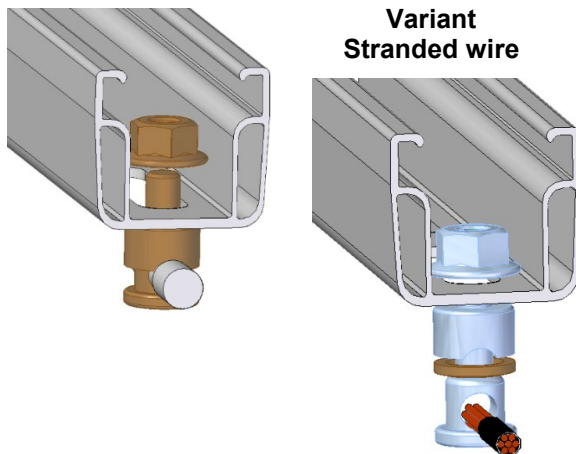

Grounding wire (\varnothing as per national specifications): Disassemble grounding connector, remove clamp washer. Push the component through the hole in the C-rail from below. Push the grounding wire (2) through the opening (suitable for \varnothing 6–10 mm) and fasten the component to the rail floor with the serrated self-locking flange nut.

Grounding cable (\varnothing as per national specifications): Strip the grounding cable (e.g. stranded wire) and push it through the opening. Leave clamp washer in place (1). Clamp to rail floor with the serrated self-locking flange nut.

NOTICE

Fastening torque for grounding wire = 20 Nm; for grounding cable = 10 Nm

The grounding connector is used to connect the mounting system to the potential equalisation.

WARNING

The applicable standards and guidelines, such as the lightning protection standard, must be observed.

MV 2.2 – Mounting the contact latch

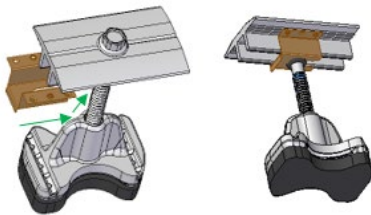

Use the sliding clip to push the contact latch over the vertical bridges of the middle clamps up to the screw.

NOTICE

The middle clamp with the contact latch in place is installed as previously described in chapter 5.3.

MV 2.3 – Mounting the strapping

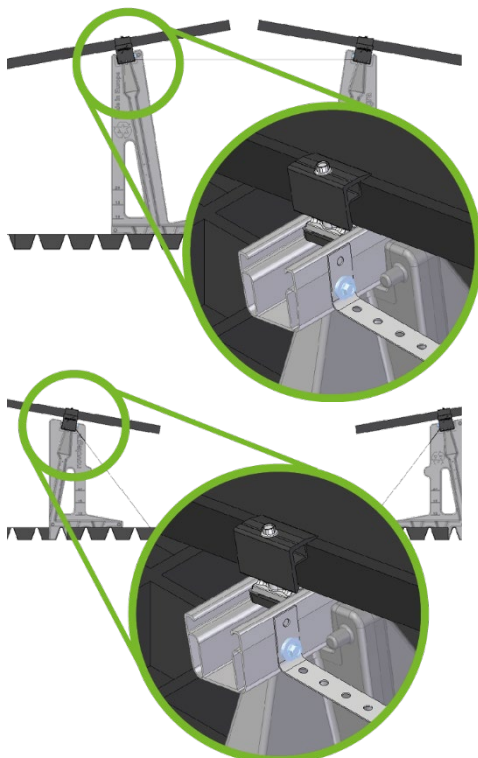

Cut aluminium strapping to size. Position the strapping over the groove at the side of the module support rail. Position the mounting screw at the groove and fasten. Mount the strapping between two high and between two low module supports.

NOTICE

The aluminium strapping is used to connect the individual module rows with each other for the potential equalisation.

WARNING

The applicable standards and guidelines, such as the lightning protection standard, must be observed.

MV 3
Module positioning: South



Follow the planning documents and position and fasten the components accordingly. Further installation steps are the same as for the east/west variant.

MV 4
Module positioning: Butterfly (east/west)

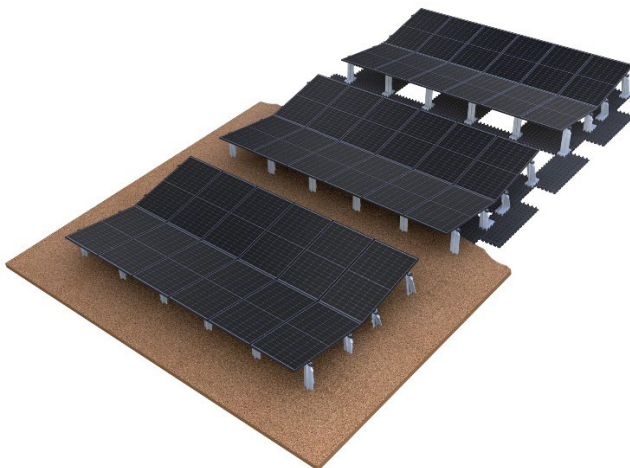

Follow the planning documents and position and fasten the components accordingly. Further installation steps are the same as for the east/west variant.

6 Warranty/ product liability (exclusion)

In addition to the regulations and safety precautions outlined above, the applicable regulations and technical rules must be observed by the specialist company responsible for the installation.

The installer is responsible for dimensioning the novotegra mounting system.

The installer is responsible for connecting the interfaces between the mounting system and the building. This also includes the integrity of the building envelope.

In the case of flat roofs, the installer is responsible for performing an independent assessment of the roof seal regarding the material of the sealing membrane, resistance, ageing, compatibility with other materials, overall condition of the roof seal, and the need for a protection layer between the roof seal and the mounting system. The necessary measures and precautions to protect the roof seal during the installation of the supporting structure for the photovoltaic system must be arranged by the installer, if necessary, with the assistance of a skilled tradesperson. novotegra GmbH assumes no liability for faulty or insufficient measures and precautions to protect the roof seal!

The verification of the assumed friction coefficient for the proof of the sliding safety of photovoltaic systems on flat roofs must be carried out by the installer. Friction coefficients determined on-site can be taken into account by entering them into the Solar-Planit planning tool. novotegra GmbH does not guarantee the accuracy of the assumed values and is not liable for damage resulting from the use of incorrect values.

The specifications of the module, cable and inverter manufacturers must be observed. In case of discrepancies with these mounting instructions, please consult your novotegra GmbH sales team or, in the case of components not supplied by novotegra GmbH, the respective manufacturer before installing the novotegra mounting system.

Limited knowledge regarding the local conditions during the preparation of novotegra offers by our sales representatives may result in modifications to the quantities initially proposed during the installation process. These changes mainly concern the number of fixings required for the building envelope (e.g. roof hooks). In this case, the additionally required components must be installed according to the dimensioning.

novotegra GmbH is not liable for faulty or incomplete data collection forms. To ensure correct dimensioning, the data collection forms must be error-free and fully completed.

The mounting instructions, warranty conditions, and liability disclaimer must all be observed.



novotegra

novotegra GmbH

Eisenbahnstraße 150
72072 Tübingen | Germany

Tel. +49 7071 98987-0
Fax +49 7071 98987-10

info@novotegra.com
www.novotegra.com

