

Mounting instructions

novotegra for flat roof
closed II / east-west II

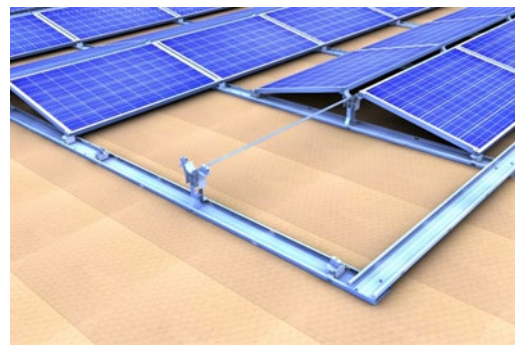
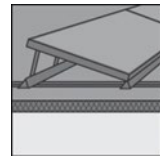

TABLE OF CONTENTS

1	Notes	1
2	Maintenance of the mounting system	3
3	novotegra for facade	4
4	System components, tools and equipment	5
4.1	What is required for mounting	5
4.2	Mounting system components – mounting versions	6
4.3	Mounting system components – optional.....	7
5	Installing the mounting system	8
5.1	Installing the base troughs and support components.....	8
5.2	Module installation, load redistribution and ballast.....	9
5.3	Mounting variations.....	11
6	Warranty / product liability (exclusion)	16

1 Notes

The following instructions are generally valid for our mounting system novotegra and are to be applied or interpreted accordingly regardless of the respective roof and mounting system type.

Safety information

Mounting tasks may only be carried out by qualified and competent persons. During the work protective clothing in accordance with the relevant national regulations and guidelines must be worn.

Mounting must be carried out by at least two persons to ensure help in case of an accident.

All relevant national and locally applicable health and safety regulations, accident prevention regulations, standards, construction standards and environmental protection regulations as well as all regulations of the employers' liability insurance associations must be complied with.

The national regulations for working at height / on the roof must be complied with.

Electrical work must be carried out in compliance with the national and locally applicable standards and guidelines and the safety rules for electrical work.

Earthing / equipotential bonding of the mounting system must be carried out in accordance with the national and locally applicable standards and guidelines.

Categorisation into hazard classes

To alert the user of potential danger situations the hazard classes analogous to ANSI Z 535 are used. The hazard class describes the risk if the safety information is not observed.

Warning symbol with signal word

Hazard class analogous to ANSI Z 535



DANGER! describes an immediate danger. If it is not avoided, death or serious injury will result.



WARNING! describes a potential danger. If it is not avoided, death or serious injury might result.



CAUTION! describes a potential danger. If it is not avoided, light or minor injury might result.



NOTE! describes a potentially harmful situation. If it is not avoided, the plant or objects in its vicinity might be damaged.

General information

After receipt the goods must be inspected for completeness using the accompanying delivery note.

BayWa r.e. Solar Energy Systems GmbH does not accept the costs, nor can we guarantee subsequent express deliveries if missing material is only noticed during mounting.

Since our mounting systems are subject to continuous development, mounting processes or components may change. Therefore, please check the current status of the mounting instructions on our website prior to mounting. We are also happy to send you current versions upon request.

The mounting system is suitable for the attachment of PV modules with standard market dimensions. Please find more detailed information about this in chapter 3.

The usability of the mounting system for the respective project must be checked for each individual case on the basis of the roof cover / roof construction / facade present.

The roof cover / roof construction / facade must meet the requirements of the mounting system with regard to load bearing capacity, support structure and condition.

Requirements for the material of the roof construction / roof cover / facade:

Wooden components (rafters/purlins): min. strength class C24, no fungus infection or rot

Tensile strength R_m , min for trapezoidal metal: steel 360 N/mm²; aluminium 195 N/mm²

Wall construction material: concrete, brick or sand-lime brick in solid or hollow block design.

The load bearing capacity of the roof / roof construction (rafters, purlins, trapezoidal metal, concrete floors, number of adhesive points, folded seams, etc.) or the facade (wall construction materials) must be checked by the user or a check be commissioned.

Physical building aspects concerning insulation penetrations (e.g. condensation) must be taken into account by the user.

Notes on mounting

The components of the novotegra mounting system are intended exclusively for the attachment of PV modules. Dependent on the roof type of the building the designated mounting system components must be used.

A condition for the intended use of the novotegra mounting system is the mandatory compliance with the specifications in these instructions regarding safety information and mounting.

In case of unintended use and non-compliance with the safety information and mounting instructions and non-utilisation of the corresponding mounting components or use of third party components not belonging to the mounting system any warranty and liability claims against the manufacturer are voided. The user is liable for damage and resulting consequential damage to other components, such as PV modules, or the building as well as personal injury.

The user must read the mounting instructions prior to mounting. Unresolved issues must be clarified with the manufacturer prior to mounting. The mounting sequence in these instructions must be adhered to.

It must be ensured that a copy of the mounting instructions is accessible in the immediate vicinity of the work on site.

The mounting specifications (module load, attachment, clamping areas etc.) of the module manufacturer must be observed and complied with.

Prior to mounting the mounting system must be statically calculated with the loads to be assumed for the building project in accordance with the national standards. Information relevant to mounting (e.g. roof hook distance, lengths of bolts, overhang and protrusions or distance of base trough and required ballast) must be determined by the static calculation using the design software www.solar-planit.

The permissible roof inclination for using the mounting system according to these installation instructions is 0 to 60 degrees for roof-parallel installation on a pitched roof and 0 to 5 degrees for elevated installation on a flat roof. Facade systems must be mounted parallel to the facade.

For roof-parallel installation with the clamping system, two module support rails per module must be mounted symmetrically under the modules for equal load transfer into the substructure. Alternatively, the roof-parallel installation can also be installed with insertion rails.

The specified tightening torques must be adhered to and checked randomly on site.

Notes on static calculations

The mounting system must generally be statically calculated for each individual project using the design software Solar-Planit. Excluding façade systems, the calculation for this will be carried out by the company BayWa r.e. Solar Energy Systems GmbH.

The static calculation only determines the load bearing capacity of the novotegra mounting system and also takes account of the attachment to the building (rafters, purlins, trapezoidal metal, facade etc.). The load transfer within the building is not considered (customer static calculations).

The load bearing capacity of the mounting system components is determined on basis of the planned module layout and the underlying building information (project data recording). Deviations from the planning on site may lead to different results.

The load assumptions (load and roof division) are country-specific in accordance with the specifications of the Eurocode load standards. The determination of the loads to be assumed for Switzerland is in accordance with SIA 261.

At pitched roof, the modules may not be fitted above the gable end, ridge and eaves or the facade (increased wind load). At the ridge the modules may be fitted up to max. a theoretical horizontal line with the ridge tile and perfectly flush with the gable end. In the eaves area the modules may reach to max. the end of the roof cover due to loads.

In case of an exposed building position (with wind load e.g. at the edge of a slope) or snow accumulation (e.g. dormer or catchment grill or roof structures like domelights etc) the specifications of the Eurocode load standards or SIA 261 (Switzerland) must be taken into account by the user within his own responsibility. The design software does not consider these cases.

The static calculation of the mounting system is based on the symmetrical placement of the modules on the mounting rails at the longitudinal side of the modules (roof-parallel clamping systems) or on the support components (elevation) for equal load transfer into the substructure. For the insertion system a cross rail arrangement is expected for equal load transfer.

The results calculated with the design software, such as distances of the fasteners (e.g. roof hooks, stock screws, saddle clamps etc.), rail lengths and number of fasteners (e.g. direct attachment on the trapezoidal metal), overhang (e.g. rail and roof hook protrusions) or distances between the base troughs and number of fixing materials (e.g. rail joint) and the other calculation notes must be considered and complied with.

novotegra has been tested and certified by TÜV Rheinland:



2 Maintenance of the mounting system

The mounting system must be checked for stability and operation at regular intervals during the system maintenance.

In addition to the visual inspection of the components, we recommend a random check of the connections and the safe and correct position of the ballast on the base rails and ballast troughs.

Removal is possible in reverse order in the work steps mentioned below.

The maintenance work must be carried out by a specialist company with proven experience in electrical systems and work on mounting systems.

3 novotegra for flat roof

The contents of this installation manual describe the installation of the substructure on roofs with sheet or bitumen waterproofing, with or without gravel respectively substratum.

Depending on the roof seal material, separation and/or protection membranes may need to be added between the roof seal and the substructure. This must be agreed upon directly between the company installing the PV system, the building owner and the specialist roof sealing company.

The substructure is installed without penetrating the roof. The PV system is secured against wind suction by providing ballast (e.g. suitable stones), based on the results of the wind tunnel tests for the system. The required ballast is determined by BayWa r.e. Solar Energy Systems GmbH based on the project data provided by the installation company. The ballast applies to the planned system; on-site deviations from planning may lead to different results.

Protection against system sliding is verified based on a coefficient of friction of $\mu = 0.5$. This value must be checked by the installation company prior to installation. If the coefficient of friction is determined by the installation company in advance, protection can be verified during planning using the determined value.

The system must be secured on site to prevent it from "creeping" due to expansion caused by temperature. This can be achieved by installing suitable stop points on the roof surface or by anchoring to the parapet, for example. The connection points on the building and building parts must be able to bear the forces exerted.











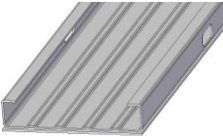
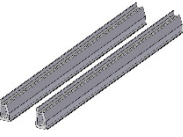



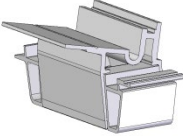

General conditions to be observed in accordance with the wind tunnel test results:

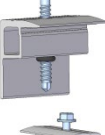
- Roof incline 0 – 5 degrees
- Flat roofs with and without parapet
- Distance from system to roof edge (without parapet) = 0.50 m
- Distance from system to parapet (inside edge) = 0.50 m
- Module width = min. 0,92 m; max. 1,08 m
- Module length = max. 2,08 m
- Angle of installation (fixed) = 13°
- Distance between rows = 1.30 – 2.40 m (closed II) respectively 2.15 – 2.40 m (East-West II)





The installation system is designed for loads of up to 2.4 kN/m² (2,400 Pa). The modules are clamped on the short frame side or, alternatively, on the long frame side in the corners (clamp surface 11 x 52 mm). This requires approval from the module manufacturer for clamping on the short frame side or on the corner of the long frame side. Any drainage openings on the module frame may not be blocked. This also applies to the features provided for this purpose on the support components.

4 System components, tools and equipment







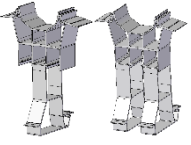

4.1 What is required for mounting

Figure	Tool	Component*	Product group
		Base trough 150-30 Material: Aluminium	Profile rails
		Base trough connector 150-30 I Material: Aluminium Tool: Socket bit AF 8 mm	Rail connectors and expansion joints
		Base trough expansion joint 150-30 Material: Aluminium and stainless steel Tool: Socket bit AF 8 mm	Rail connectors and expansion joints
		Base foot set Material: Aluminium	Module elevation
		Module support set 13° Material: Aluminium	Module elevation
		Flat roof mid clamp Material: Aluminium and stainless steel Tool: Socket bit AF 8 mm	Module elevation
		Flat roof end clamp Material: Aluminium and stainless steel Tool: Socket bit AF 8 mm	Module elevation
		Flat roof end clamp (short side) Material: Aluminium and stainless steel Tool: Socket bit AF 8 mm	Module elevation
		Wind deflector 13° Material: Aluminium Tool: Socket bit AF 8 mm	Module elevation
		Flat roof mounting screw chipless Material: stainless steel Tool: Socket bit AF 8 mm	Fastening equipment
		Aluminium edge protector self-adhesive Material: Aluminium	Sealing parts and protective devices

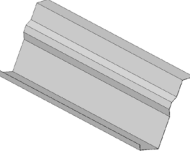
* The components vary depending on the requirements of the roof, the structural analysis and the choice of components and may deviate from the images above.

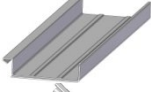









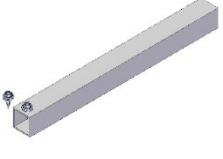

Figure	Equipment	Use for tool	Application
	Cordless screwdriver	Bit Torx TX 40 Socket bit AF 8 mm	Component connections, clamp assembly
	Torque key up to at least 12 Nm	Socket bit AF 8 mm	Clamp assembly
	Chop saw	---	Cutting rails
	Place / replace tool base trough 150-30	For place / replace of base foot and module supports set in the base trough 150-30	Correct installation

4.2 Mounting system components – mounting versions

Figure	Tool	Component**	Product group
		Module support set 13° e/w Material: Aluminium	Module elevation
		Support brace 20x20x1.5 Material: Aluminium	Profile rails
		Wind deflector 13° e/w Material: Aluminium Tool: Socket bit AF 8 mm	Module elevation
		C-rail (base profile, base trough) Material: Aluminium	Profile rails
		Rail connector set Material: Aluminium and stainless steel Tool: Special lock nut AF 18 deep	Profile rails
		PE pad 140 x 390 x 20 mm Material: PE foam	

** Required components for ballast distribution at system edge, depending on substructure construction.

4.3 Mounting system components – optional

Image	Tool	Component***	Product group
		Ballast trough Material: Aluminium	Module elevation
		Coupling profile C47 385 mm Material: Aluminium Tool: Socket bit AF 8 mm	Profile rails
		Base trough cable bracket Material: Plastic	Cable management
		Top cover base trough 150-30 3.00 m Material: Aluminium	Module protection and rail top cover
		Cable-tie clip for profile flange	Cable fixing
		Cable clip d = 10 mm	Cable fixing
		Grounding connector set AF 18 Material: stainless steel Tool: Special lock nut AF 18 deep	Accessories and optional components
		Perforated Alu-tape 10,000 x 20 x 1 Material: Aluminium Tool: Socket bit AF 8 mm	Accessories and optional components
		Mounting-Set Optimizer FR	Accessories and optional components
		Contact latch module clamp	Accessories and optional components

*** Optionally available installation system components, e.g. for improving the aesthetics of the system, cable management or grounding of the installation system.

5 Installing the mounting system

Prior to installation, the module array must be measured out on the roof and the position of the modules determined, taking into account any obstacles such as light domes or strips, fans or drains.

The individual installation steps of the system variant closed II (south facing) are described below. References are made to mounting versions (MV) for the various design possibilities respectively to the system variant east-west II. The associated work steps are described at the end.

5.1 Installing the base troughs and support components

Arranging the base troughs

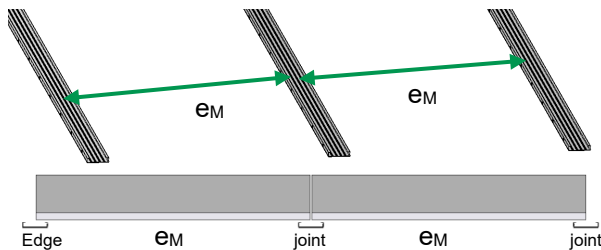

Install the base troughs centrally beneath the module joint (MV 1).
 Maximum module field size without measurements (MV 4) for compensation of temperature-related length expansions 17 x 17 m (Module field 10 x 10 with approx. 1.70 m row distance).
 Distance to adjacent module field: min. 50 mm

NOTICE

System edge / module joint:
 $e_M = \text{module length} + 12 \text{ mm}$

WARNING

Observe the accident prevention regulations when sawing.

Base trough variations

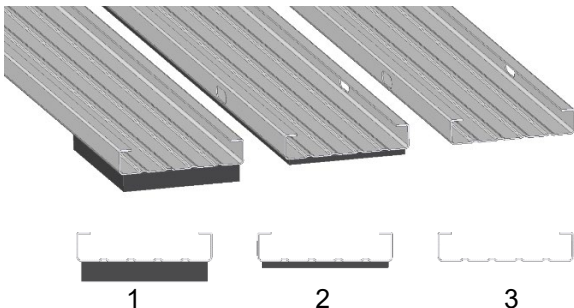

Selection of the base trough depends on the respective project with recognition to the roof characteristics.

NOTICE

1. base trough 150-30 w/cross drainage
2. base trough 150-30 w/protection layer
3. base trough 150-30 (bare)

Connecting the base troughs

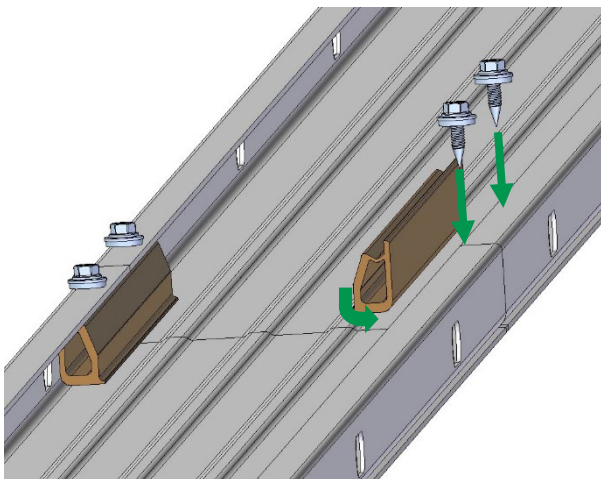

Push the ends of the base troughs tightly together, put the connectors under the ridge of the base troughs and fix them by using two screws for each connector.

Maximum uninterrupted rail length approx. 17 m, then install expansion joint or disconnect the rail (MV 4).

The base trough joints and base trough ends must be covered using the self-adhesive edge protection provided.

NOTICE

The distance between the base troughs in the joint may not exceed 100 mm.

Installing the base foot

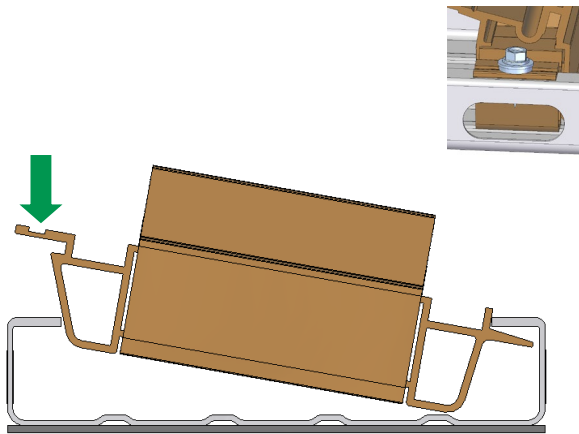

Insert the component into the base trough on one side as shown and then click into the base trough. If a base foot is located above an elongated hole, it must always be secured with a screw.

NOTICE

Prior to installation, the position (installation axis) of the components must be determined on the base trough. Depending on the conditions on site, it's recommended to use the mounting and removal tool.

Installing module supports

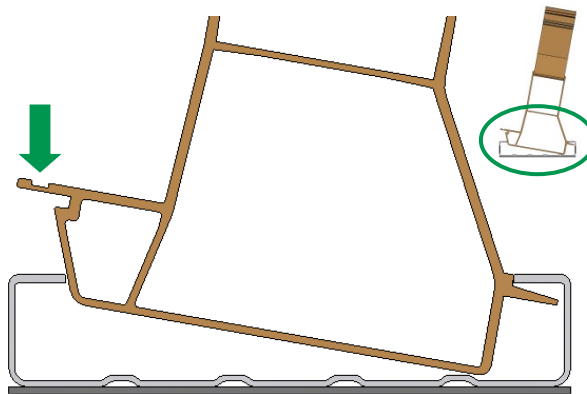

Insert the component into the base trough on one side as shown and then click into the base trough. Installation module support east-west regarding MV 6.

NOTICE

Prior to installation, the position (installation axis) of the components must be determined on the base trough. Depending on the conditions on site, it's recommended to use the mounting and removal tool.

5.2 Module installation, load redistribution and ballast

Installing the module

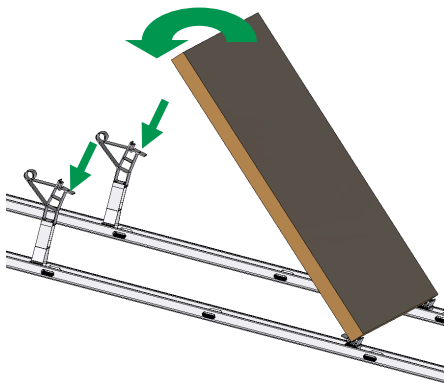

Place the module landscape on the base feet and put it on the module support set afterwards. Please see MV 7 for further information regarding module installation for east-west II.

NOTICE

Connect the cables of adjacent modules while installing them. Place the string cables first.

Fastening the modules on the row end

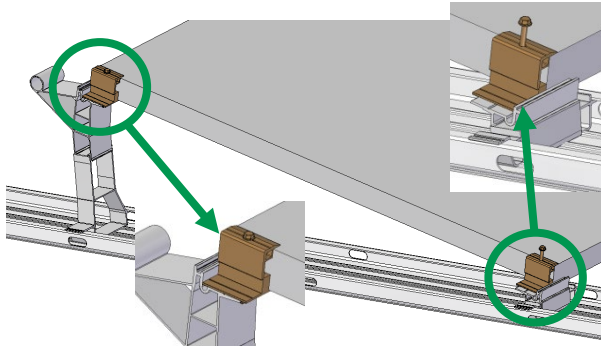

Secure modules at the end of a row or at an interruption in the row (light domes, fans, etc.) using the flat roof end clamp (short side).

Push the clamping block of the module fastener beneath the module, place the fastener on the module and fix the drilling screw through the borehole.

NOTICE

Tightening torque max. 6 Nm.
The screw must not be overtightened!
Clamping takes place on the short frame side.
Please observe the mounting instructions of the module manufacturer.

Fastening the module to the module joint

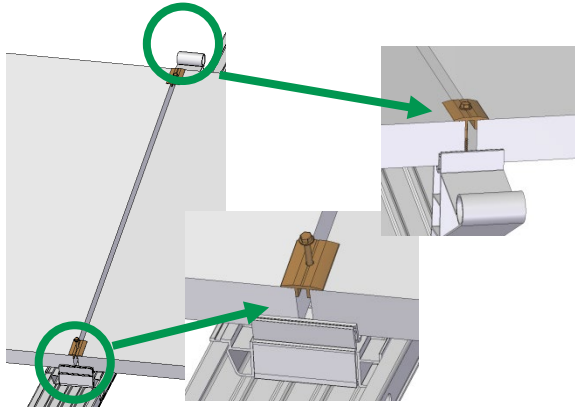

Place the subsequent module on the base foot or module support. Determine the gap between the modules (12 mm) by inserting the flat roof mid clamp. Insert the module fasteners so that the drilling screw is positioned in the borehole on the base foot or module support.

NOTICE

Tightening torque max. 6 Nm.
The screw must not be overtightened!
Clamping takes place on the short frame side.

Connection rail

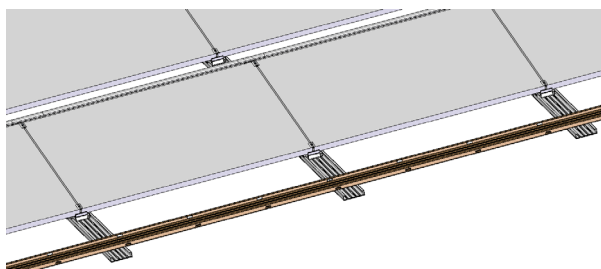

To reduce ballast on the southern (East-West) edge or at interruptions in the system (e.g. along light domes or maintenance walkways), place a base trough 150-30 rectangular on the base troughs as a connection rail and each with two screws per base trough. Extension using base trough connectors or expansion joints at system interruptions. Arrange the expansion joints identically to the expansion joints of the module supports. Cut the base troughs to length if required.

The connection rail can be used to place the string cable or to insert / put on the required ballast.

NOTICE

Further rails can be used to redistribute load:
C-rail 47, 71 and 95, support brace

Ballast

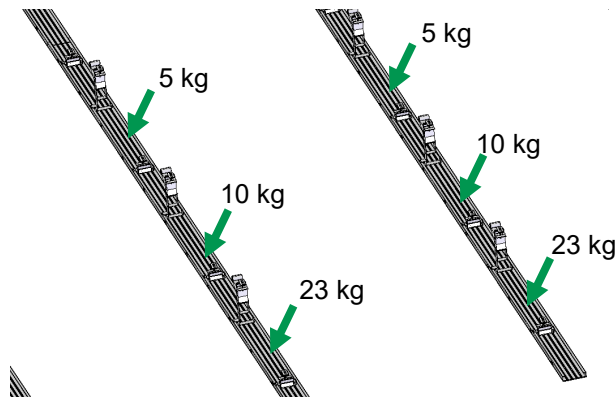

Place the required ballast in accordance to the ballast planning inside or on top of the base troughs after installing the modules. The required ballast depends on the system area and is specified in the ballast plan in kg and/or number of stones. The ballast can be laid out under, in front of or behind the module to place all the required ballast. The selection of the ballast stone is up to the customer, the dimensions are to be adapted to the weight of the ballast indicated at each point.

NOTICE

For ballast installations using large amounts of ballast, ballast troughs (MV 9) or additional base troughs under the module are recommended (MV 5).

Installing the wind deflector

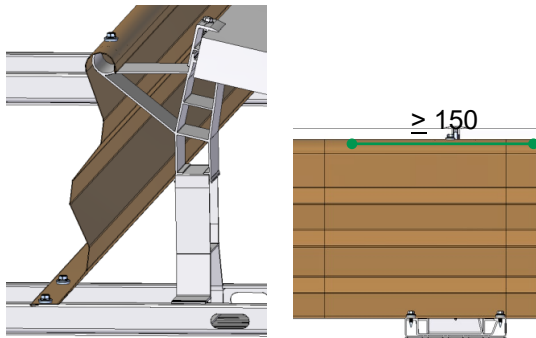

Guide the wind deflector over the round part of the module supports and place it on the base trough. Install the adjacent wind deflector for the following module with an overlap of at least 150 mm to the first wind deflector.

Secure the wind deflectors to the base troughs with two screws for each base trough and to the round part of the module support with one screw.

NOTICE

The screw must not be overtightened!

5.3 Mounting variations

Explanation of the installation variants depending on the roof construction or design variants.

MV 1 – Flush base troughs on system edge

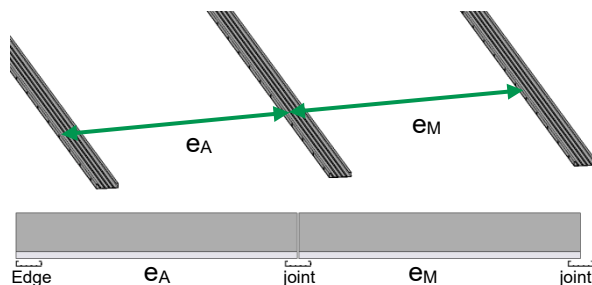

Alternatively, the first base trough at the system edge / expansion joint must be installed flush with the modules, the subsequent troughs must be positioned centrally beneath the module joint.

NOTICE

Prerequisite:

Flat roof end clamp (MV 2)

Approval module manufacturer for module clamping required

System edge / expansion joint:

e_A = module length – 69 mm

Module joint:

e_M = module length + 12 mm

MV 2 – Module fastening long side

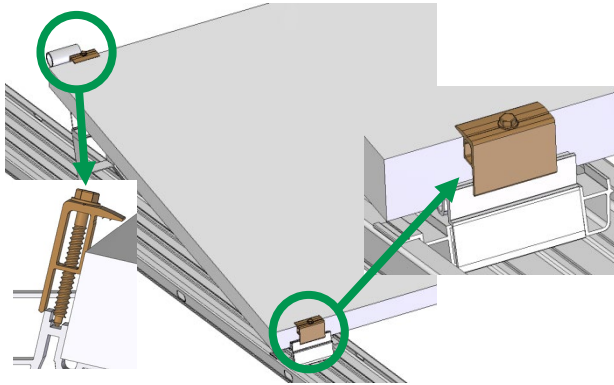

Place the drilling screw from the flat roof end clamp centred over the screw channel of the base foot or module support and screw in.

NOTICE

Tightening torque max. 6 Nm.
The screw must not be overtightened!
Approval from manufacturer required for clamping in the corner section of the long frame side.

MV 3 – Base troughs for cross drainage

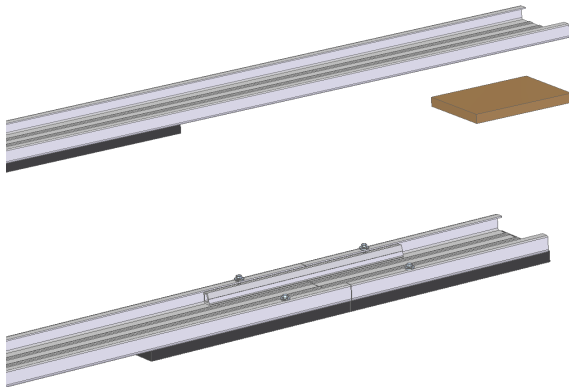

If the base trough 150-30 w/cross drainage has to be cut to size on site and then starts/ends without a PE-pad, then a PE pad must also be applied on.

Distance between PE pads: max. 610 mm

NOTICE

Shorten PE-pad to the required length if necessary.

The base trough has always to start/end with a PE-pad.

MV 4 – Installation of expansion joints in the base troughs

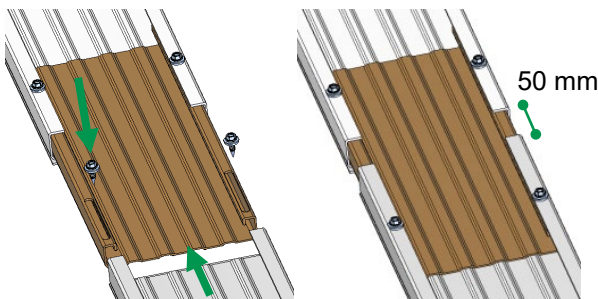

Push the base trough expansion joint centrally into the adjacent base troughs. A gap of 50 mm must remain between the ends of the base troughs. Fix the expansion joints to the base troughs. On the movable side, the two screws must be screwed into the base trough so that they are centred in the elongated holes.

NOTICE

Do not install the expansion joint below a module.
Max. base trough length without base trough expansion joint approx. 17 m, with the base trough expansion joint approx. 34 m, plan for proper expansion joints after this.

MV 5 – Mounting 3rd base trough

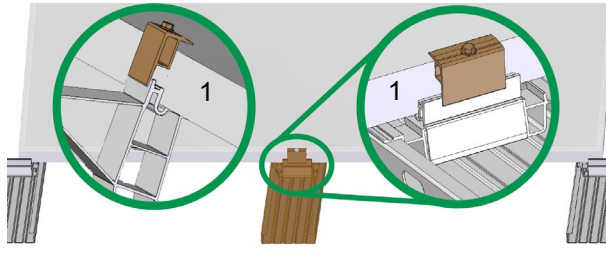

Depending on the ballast, a 3rd base trough may be required for additional storage space. It should be positioned centrally between two base troughs according to the ballast plan. Secure the module in addition to the clamps at the corners using the flat roof end clamp on the long side (1). The installation of a 3rd base trough may also be necessary if the module support set or the base foot is overloaded.

NOTICE

Secure the wind deflectors to the base troughs with two screws for each base trough and to the round part of the module support with one screw.

MV 6 – Module supports east-west

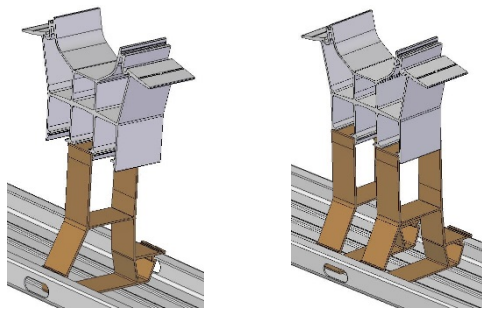

Regarding the occurring loads the module support set of the east-west II system variant must be installed with a single or a double leg.

NOTICE

Prior to installation, the position (installation axis) of the components must be determined on the base trough.

Depending on the conditions on site, it's recommended to use the mounting and removal tool.

MV 7 – Installing the module – system variant east-west II

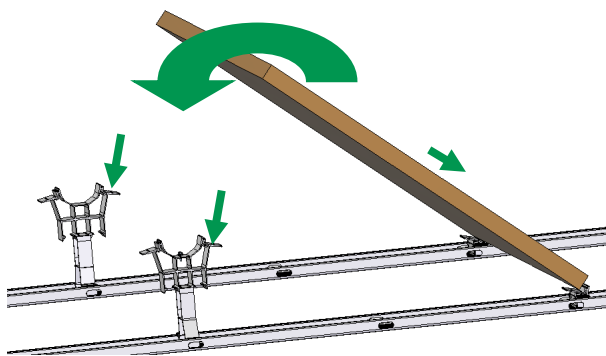

Place the module landscape on base feet and then put it on the module support set. Install the modules of one axis of a double row first.

Place the required ballast in accordance to the ballast planning inside or on top of the base troughs after installing the modules.

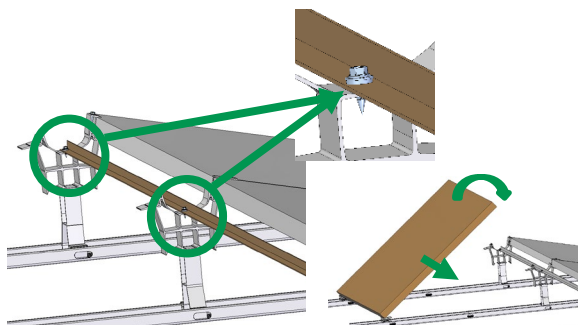

After fixing the modules place the support brace on the module support set and fit them together with one screw each. Support brace joint overlapping above the module support brace.

Place ballast and install the modules on the other side of the double row on the module support set.

NOTICE

Wire adjacent modules when installing them. Install the string cable first.

MV 8 – Wind deflector east-west II

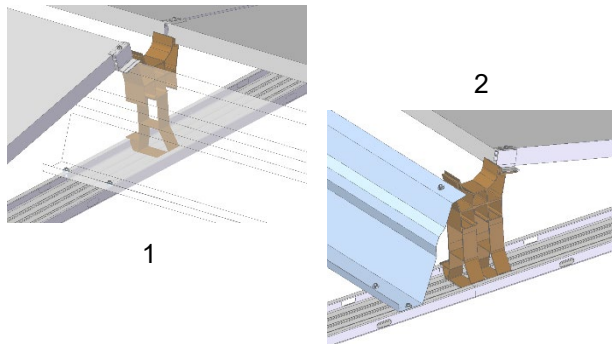

Support wind deflector to module (1):
Place wind deflector under module, fasten module and wind deflector with module fastener E-K on support and with two further screws on the base trough.

Support wind deflector to wind deflector or edge (2):
Mount the east-west wind deflector on the module support set 2S as described in the section Mounting the wind deflector, on the base trough with two screws and on the module support with one screw.

NOTICE

Place the weight of the replaced module with ballast stones into the east-west wind deflector.

MV 9 – Ballast troughs

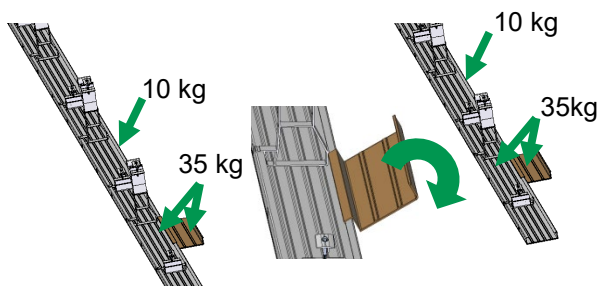

Using ballast troughs allows small and large ballast which can be securely inserted or laid on if required. The ballast troughs must be mounted sideways to the base troughs.

MV 10 – Installation of the coupling profiles for ballast reduction

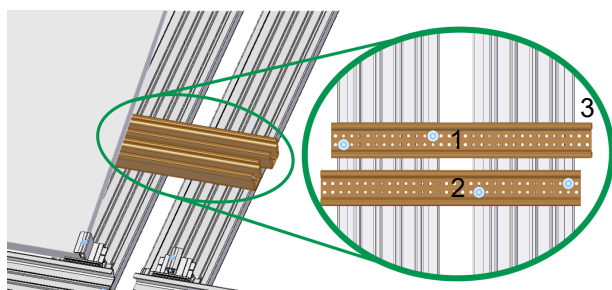

Connect parallel module fields with two coupling profiles. Secure the first profile (1) with two screws on the left base trough and then secure the second profile (2) on the right base trough. Leave the loose end of the coupling profile protruding over the edge of the second base trough (3).

NOTICE

The coupling profile is only firmly secured to one base trough.
Distance between base troughs 50 mm.

MV 11 – equipotential bonding and lightning current carrying capacity

MV 11.1 – Attaching grounding connectors

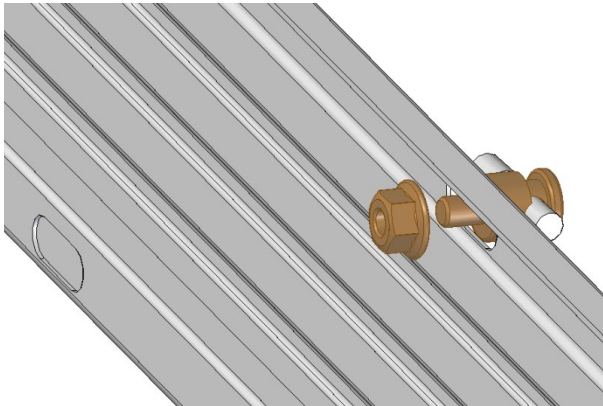

Ground wire (\varnothing according to national specifications):

Disassemble grounding connector, remove clamping disk. Push component through elongated hole in the base trough. Push ground wire through the opening (suitable for \varnothing 6-10 mm) and attach the component with the self-locking nut.

NOTICE

Ground wire tightening torque 20 Nm.

⚠ WARNING

The applicable standards and guidelines, e.g. lightning protection standard, must be observed.

MV 11.2 – Attaching contact latch module clamp

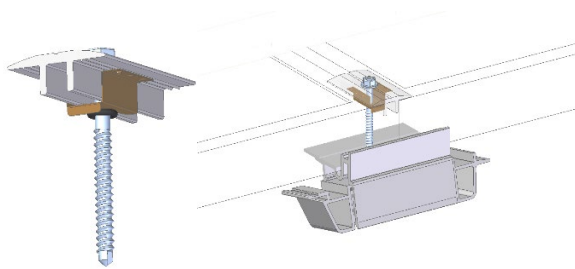

Slide the contact latch on the sliding bracket over the longitudinal bars of the middle clamp push it up the screw. Tightening torque as described above. The contact plate is used for equipotential bonding and lightning current carrying capacity of the system.

6 Warranty / product liability (exclusion)

In addition to the above-mentioned regulations and safety notices the applicable regulations and rules of technology must be observed by the installing specialist company.

The installer is responsible for the dimensioning of the mounting system.

The installer is responsible for the connection of the interfaces between the mounting system and the building. This also includes the tightness of the building envelope.

For flat roofs the roof insulation must be evaluated by the installer on site within his own responsibility regarding the material of the sealing layer, resistance, ageing, compatibility with other materials, overall condition of the roof insulation, need for a separating layer between the roof insulation and the mounting system. The required and necessary measures or precautions for the protection of the roof insulation for the mounting of the substructure of a PV system must be initiated by the installer with the aid of a specialist tradesman where necessary. BayWa r.e. Solar Energy Systems GmbH does not accept liability for faulty or inadequate measures and precautions for the protection of the roof insulation!

The installer must review the friction coefficient used in the calculation for the verification of the slip safety of PV systems on flat roofs on site. Friction coefficients determined on site can be taken into account by entering them in the Solar-Planit planning tool. BayWa r.e. Solar Energy Systems GmbH does not guarantee the correctness of the assumed values and is not liable for damage due to the use of incorrect values.

The specifications of the module, cable and inverter manufacturers must be observed. If these contradict the mounting instructions, always consult the BayWa r.e. Solar Energy Systems GmbH sales team before mounting the novotegra mounting system or – in the case of components not supplied by BayWa r.e. Solar Energy Systems GmbH – the manufacturer concerned.

During the preparation of the offers for novotegra by our sales staff the local conditions are not always sufficiently known, which is why changes to the offered quantities may result during installation. These changes relate mainly to the number of fasteners for the building envelope (for example roof hooks). In this case the additionally required components must always be installed in accordance with the dimensioning.

BayWa r.e. Solar Energy Systems GmbH is not liable for incorrect or incomplete data collection sheets. Error-free and fully completed data collection sheets are essential for correct dimensioning.

The information in the mounting instructions, the warranty terms and the information about the liability exclusion must be noted.



BayWa r.e. Solar Energy Systems GmbH

Eisenbahnstraße 150
D-72072 Tübingen
Tel. +49 7071 98987-0
Fax +49 7071 98987-10
solarenergysystems@baywa-re.com

www.baywa-re.com
solar-distribution.baywa-re.de
novotegra.de